

MULTI-FIX

Service 2 unit | BGO

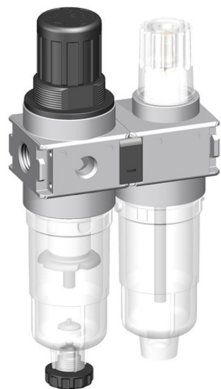

Image shows:  
9.2800.00.000

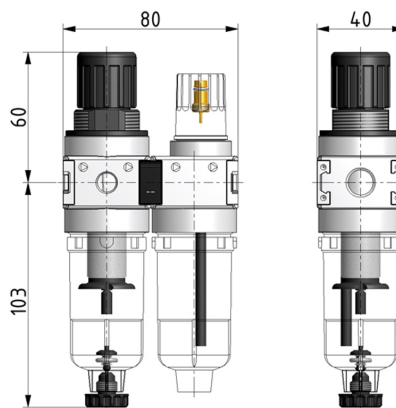
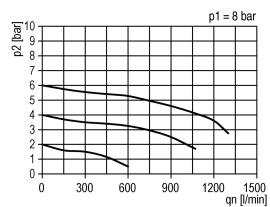
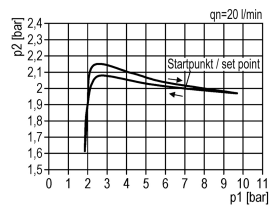

Image shows:  
9.2800.00.000

flow characteristic



pressure characteristic



lubricator operating limit

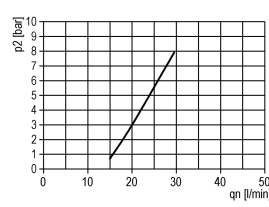

symbol

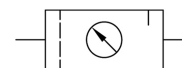

technical data

- **description:** sinter filter centrifugal principle, diaphragm-type pressure with relieving feature, micro mist lubricator
- **medium:** compressed air, neutral gases
- **supply pressure P1 min.:** 1,5 bar
- **supply pressure P1 max.:** 12 bar
- **temperature range:** 0 - 60°C
- **bowl:** PC
- **drain:** HA
- **mounting:** vertical
- **filter element:** 5 µm
- **bowl volume lubricator:** 35 cm<sup>3</sup>
- **oil metering qv=1.000/min:** 10 - 20 drops/min
- **oil type:** CL 32 DIN 51517 - ISO VG 32

accessories



- coupling kit wall mounting:  
[ZW.00-1](#)

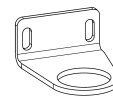

- control panel mounting:  
[MW.30/DR.00-34-2](#)

- lockable setting knob possible

type	part-number	description
CL.00 HA4	9.2800.00.000	Service 2 unit G1/8 0,5-10 5µm with PC bowl and semi automatic drain
CL.00 B HA4	9.2800.00.001	Service 2 unit G1/8 0,5-10 5µm with PC bowl, bowl guard and semi automatic drain
CL.00 AM10	9.2800.00.004	Service 2 unit G1/8 0,5-10 5µm with PC bowl and automatic drain
CL.00 M HA4	9.2800.00.006	Service 2 unit G1/8 0,5-10 5µm with metal bowl and semi automatic drain
CL.01 HA4	9.2801.00.000	Service 2 unit G1/4 0,5-10 5µm with PC bowl and semi automatic drain
CL.01 B HA4	9.2801.00.001	Service 2 unit G1/4 0,5-10 5µm with PC bowl, bowl guard and semi automatic drain
CL.01 AM10	9.2801.00.004	Service 2 unit G1/4 0,5-10 5µm with PC bowl and automatic drain
CL.01 M HA4	9.2801.00.006	Service 2 unit G1/4 0,5-10 5µm with metal bowl and semi automatic drain

- Service 3 unit
- Service 2 unit
- Filter regulator
- Filter
- Pressure regulator
- Lubricator
- System extensions
- Accessories
- Special products