

Futura filters

Filter | BGO



Image shows:  
91300.CC00

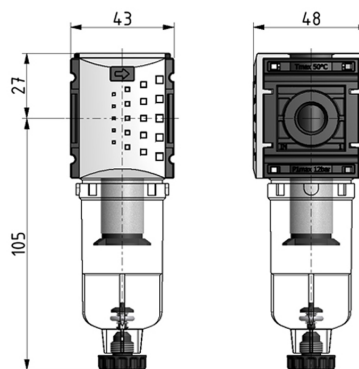
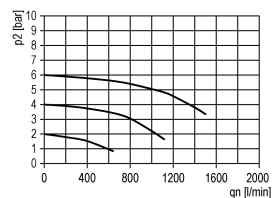
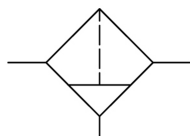

Image shows:  
91300.CC00

flow characteristic



symbol



technical data

- **description:** sinter filter centrifugal principle
- **medium:** compressed air, neutral gases
- **supply pressure P1 min.:** 1,5 bar
- **supply pressure P1 max.:** 12 bar
- **temperature range:** 0 - 50°C
- **bowl:** PC
- **drain:** HA
- **mounting:** vertical
- **filter element:** 5 µm

accessories



- **mounting bracket:**  
[KBW.0-1225](#)



- **coupling kit wall mounting:**  
[KKOP.0W](#)

type	part-number	description
KFIL-014	91300.CC00	Filter G1/4 5µm with PC bowl and semi automatic drain
KFIL-014 AM	91300.CC01	Filter G1/4 5µm with PC bowl and automatic drain
KFIL-014 M	91300.CC50	Filter G1/4 5µm with metal bowl and semi automatic drain
KFIL-014 M AM	91300.CC51	Filter G1/4 5µm with metal bowl and automatic drain

Service 3 unit

Service 2 unit

Filter regulator

Filter

Pressure regulator

Lubricator

System extensions

Accessories

Special products

**Filter | BG1**



Image shows:  
91301.CC00

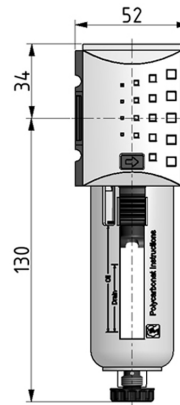

Image shows:  
91301.CC00



Service 3 unit

Service 2 unit

Filter regulator

**Filter**

Pressure regulator

Lubricator

System extensions

Accessories

Special products

**flow characteristic**

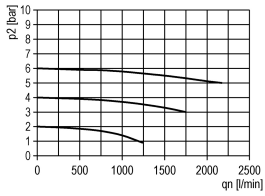

**symbol**

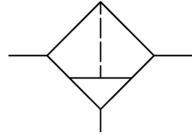

**technical data**

- **description:** sinter filter centrifugal principle
- **medium:** compressed air, neutral gases
- **supply pressure P1 min.:** 1,5 bar
- **supply pressure P1 max.:** 16 bar
- **temperature range:** 0 - 50°C
- **bowl:** PC with PA bowl guard
- **drain:** HA
- **mounting:** vertical
- **filter element:** 5 µm

**accessories**



- **mounting bracket:**  
[KBW.1-1225](#)



- **coupling kit wall mounting:**  
[KKOP.1W](#)

type	part-number	description
KFIL-114	91301.CC00	Filter G1/4 5µm with PC bowl, bowl guard and semi automatic drain
KFIL-114 AM	91301.CC01	Filter G1/4 5µm with PC bowl, bowl guard and automatic drain
KFIL-114 H	91301.CC50	Filter G1/4 5µm with metal bowl and semi automatic drain
KFIL-114 H AM	91301.CC51	Filter G1/4 5µm with metal bowl and automatic drain
KFIL-138	91301.DD00	Filter G3/8 5µm with PC bowl, bowl guard and semi automatic drain
KFIL-138 AM	91301.DD01	Filter G3/8 5µm with PC bowl, bowl guard and automatic drain
KFIL-138 H	91301.DD50	Filter G3/8 5µm with metal bowl and semi automatic drain
KFIL-138 H AM	91301.DD51	Filter G3/8 5µm with metal bowl and automatic drain

- Service 3 unit
- Service 2 unit
- Filter regulator
- Filter**
- Pressure regulator
- Lubricator
- System extensions
- Accessories
- Special products

**Filter | BG2**



Image shows:  
91302.DD00

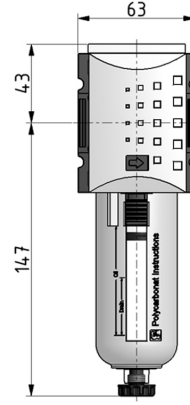
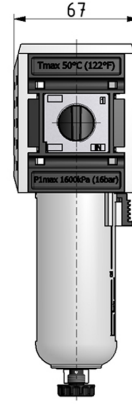

Image shows:  
91302.DD00



Service 3 unit

Service 2 unit

Filter regulator

**Filter**

Pressure regulator

Lubricator

System extensions

Accessories

Special products

**flow characteristic**

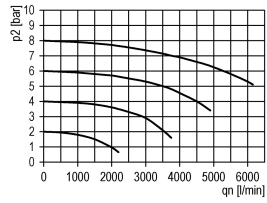

**symbol**

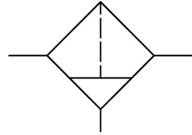

**technical data**

- **description:** sinter filter centrifugal principle
- **medium:** compressed air, neutral gases
- **supply pressure P1 min.:** 1,5 bar
- **supply pressure P1 max.:** 16 bar
- **temperature range:** 0 - 50°C
- **bowl:** PC with PA bowl guard
- **drain:** HA
- **mounting:** vertical
- **filter element:** 5 µm

**accessories**

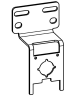

- **mounting bracket:**  
[KBW.2-1225](#)

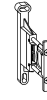

- **coupling kit wall mounting:**  
[KKOP.2W](#)

type	part-number	description	price (pre-tax)
KFIL-238	91302.DD00	Filter G3/8 5µm with PC bowl, bowl guard and semi automatic drain	
KFIL-238 AM	91302.DD01	Filter G3/8 5µm with PC bowl, bowl guard and automatic drain	
KFIL-238 H	91302.DD50	Filter G3/8 5µm with metal bowl and semi automatic drain	
KFIL-238 H AM	91302.DD51	Filter G3/8 5µm with metal bowl and automatic drain	
KFIL-212	91302.EE00	Filter G1/2 5µm with PC bowl, bowl guard and semi automatic drain	
KFIL-212 AM	91302.EE01	Filter G1/2 5µm with PC bowl, bowl guard and automatic drain	
KFIL-212 H	91302.EE50	Filter G1/2 5µm with metal bowl and semi automatic drain	
KFIL-212 H AM	91302.EE51	Filter G1/2 5µm with metal bowl and automatic drain	

- Service 3 unit
- Service 2 unit
- Filter regulator
- Filter**
- Pressure regulator
- Lubricator
- System extensions
- Accessories
- Special products

**Filter | BG4**



Image shows:  
91304.FF00

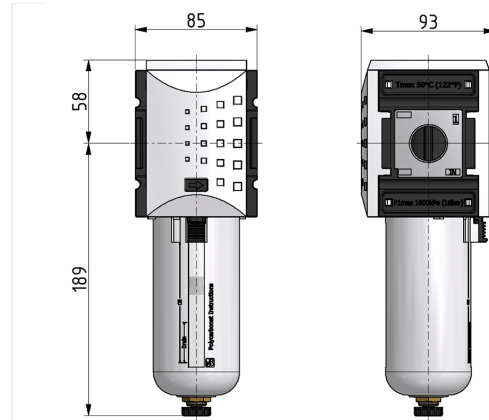

Image shows:  
91304.FF00

Service 3 unit

Service 2 unit

Filter regulator

**Filter**

Pressure regulator

Lubricator

System extensions

Accessories

Special products

**flow characteristic**

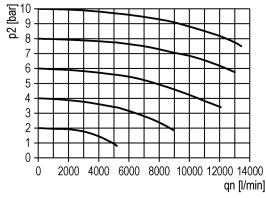

**symbol**

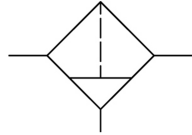

**technical data**

- **description:** sinter filter centrifugal principle
- **medium:** compressed air, neutral gases
- **supply pressure P1 min.:** 1,5 bar
- **supply pressure P1 max.:** 16 bar
- **temperature range:** 0 - 50°C
- **bowl:** PC with PA bowl guard
- **drain:** HA
- **mounting:** vertical
- **filter element:** 5 µm

**accessories**



- **mounting bracket:**  
[KBW.4-1225](#)



- **coupling kit wall mounting:**  
[KKOP.4W](#)

type	part-number	description
KFIL-434	91304.FF00	Filter G3/4 5µm with PC bowl, bowl guard and semi automatic drain
KFIL-434 AM	91304.FF01	Filter G3/4 5µm with PC bowl, bowl guard and automatic drain
KFIL-434 H	91304.FF50	Filter G3/4 5µm with metal bowl and semi automatic drain
KFIL-434 H AM	91304.FF51	Filter G3/4 5µm with metal bowl and automatic drain
KFIL-41	91304.GG00	Filter G1 5µm with PC bowl, bowl guard and semi automatic drain
KFIL-41 AM	91304.GG01	Filter G1 5µm with PC bowl, bowl guard and automatic drain
KFIL-41 H	91304.GG50	Filter G1 5µm with metal bowl and semi automatic drain
KFIL-41 H AM	91304.GG51	Filter G1 5µm with metal bowl and automatic drain

- Service 3 unit
- Service 2 unit
- Filter regulator
- Filter**
- Pressure regulator
- Lubricator
- System extensions
- Accessories
- Special products