

Lubricator FUTURA-SERIE

Kenngroßen	Typ	KLUB-114	KLUB-138
port size		G 1/4	G 3/8
description		lubricator with automatic oil filling	
medium		compressed air, neutral gases	
mounting		vertical	
medium- and ambient temperature		max. 50 °C	
supply pressure		Pe max. 16 bar	
bowl volume		oil quantity max. 40 cm ³	
oil metering qv=1000l/min		1 - 2 drops/min	
oil type		CL 32 DIN 51517 - ISO VG 32	
fixing		mounting bracket, wall mounting	
weight		0,230 kg	



Technical modifications keep on reserve!

parts

no.	designation		material	order-no.
1	bowl	BE.1 LUB	polycarbonate	90001.0202
2	dome assembly	ESA-1-1312	polycarbonate	99901.1312
3	o-ring 32 x 2,5	OR.0-1	NBR	10020.0001

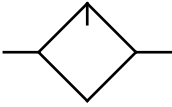

series 1

ordering information

KLUB - *** *

type

1 port size 2 accessories

ordering example: KLUB-114

1	port size	
	114	G 1/4
	138	G 3/8
	114 NPT	1/4-18 NPT
	138 NPT	3/8-18 NPT
2	accessories (see reverse side)	
	H	metal bowl with level indicator
	N	electrical level indicator

application information

- Can be filled with oil during operation
- Interlocking of several individual devices requires coupling kit(s) KOP.1

page: KLUB-1 (01/09)

dimensions (mm)

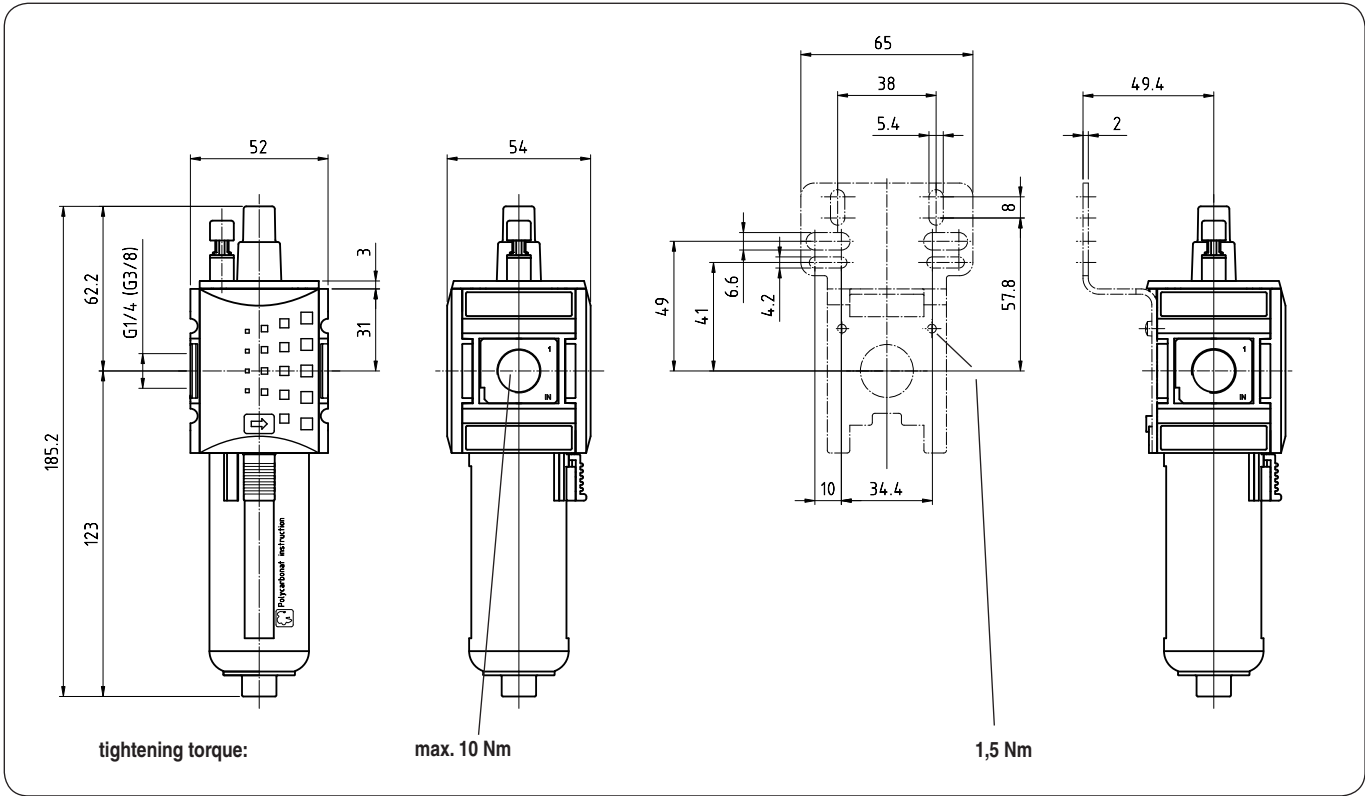

pressure characteristic

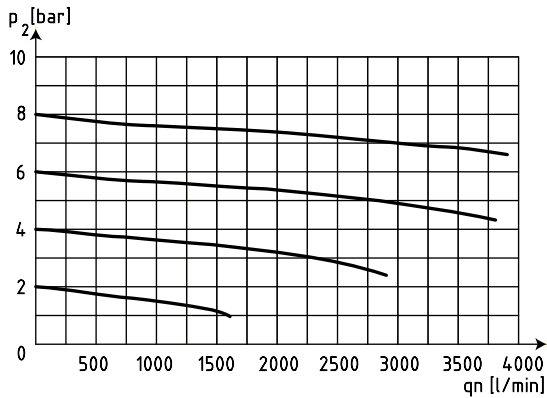

lubricator operating limit

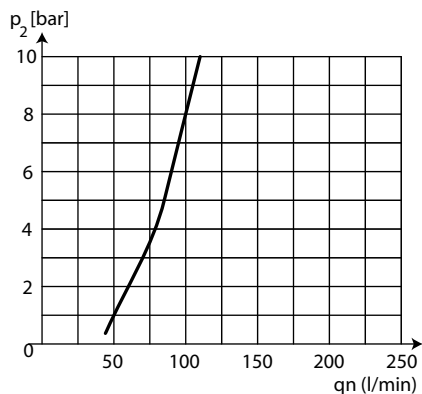

accessories 2

mounting bracket with screws

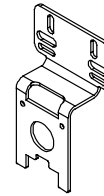

type: KBW.1-1225

metal bowl with level indicator

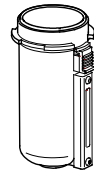

type: BE.1 H LUB

coupling kit

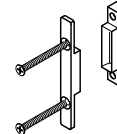

type: KKOP.1

coupling kit wall mounting

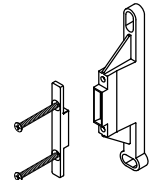

type: KKOP.1W