

Standard cylinders DNC, ISO 15552

FESTO



Standard cylinders DNC, ISO 15552

Key features

At a glance



DIN



- Standards-based cylinders to ISO 15552 (corresponds to the withdrawn standards ISO 6431, DIN ISO 6431, VDMA 24 562, NF E 49 003.1 and UNI 10290)
- The modern design and construction save up to 11% on fitting space compared to ordinary standard cylinders, thus permitting a considerably more compact system design
- An extensive range of accessories makes it possible to install the cylinder virtually anywhere
- The widest range of variants on the market provides the right DNC cylinder for every application

Cylinder with clamping units

DNC-KP



- Piston rod can be held or clamped in any position
- Piston rod can be held in position for long periods even with alternating loads, fluctuating operating pressure or leaks in the system

DNCKE



- Suitable for use in safety-related control systems in compliance with EN 954-1, EN 1050, EN 292 and EN 983
- Fail-safe
- Piston rod can be clamped in any position

Cylinder with end-position locking

DNC- ... -EL



- Mechanical locking when the end position is reached
- Lock is only automatically released when pressure is supplied to the cylinder
- End-position locking at one or both ends

Cylinder/valve combination

DNC-V1 ... V6



- The cylinder/valve combination is assembled and fitted with tubing ready for connection
- Particularly suitable for decentralised use in larger systems

Tandem cylinder

DNCT



- Connection of 2 cylinders with the same piston diameter and stroke in series
- Double the thrust and return force in comparison to a standard cylinder

Longer service life thanks to the bellows kit DADB



















The bellows kit is a leak-free system. To prevent unwanted media being drawn in, the supply and exhaust air must be ducted via a pressure compensation hole in the connection part 1.

The kit protects the piston rod, seal and bearings from a wide range of media, for example:

- dust,
- chips,
- oil,
- grease,
- fuel.

Standard cylinders DNC, ISO 15552

Key features

Variants from the modular product system		
Symbol	Key features	Description
	S2 Through piston rod	For working at both ends with the same force in the forward and return stroke, for attaching external stops
	S6 Heat-resistant seals	Temperature resistance up to max. 120 °C
	S10 Constant motion (slow speed) at low piston speeds	Suitable for slow stroke movements at a constant, stick-slip-free speed over the full stroke of the cylinder. Seal contains silicone grease (not free of paint-wetting impairment substances)
	S11 Low friction	Special seals considerably reduce system wear. This means a considerably lower response pressure. Seal contains silicone grease (not free of paint-wetting impairment substances)
	S20 Through, hollow piston rod	For supplying vacuum, small parts, media, etc.
	K2 Extended male piston rod thread	–
	K3 Female piston rod thread	–
	K5 Special piston rod thread	Metric standard thread to ISO
	K7 Piston rod with external hexagon	Special spanner flats
	K8 Extended piston rod	–
	K10 Smooth anodised aluminium piston rod	Ideal for use in welding environments: – Protection against welding spatter – Small working loads – Harder surface compared to steel – Long service life
	KP With clamping unit	Integrated clamping unit on the piston rod
	EL With end-position locking	Positive locking in the end position as a drop guard. If there is a drop in pressure, the piston rod is secured in its end position to prevent it from dropping
	Q Square piston rod	Protection against rotation. For correctly oriented feeding
	R3 High corrosion protection	All external cylinder surfaces comply with corrosion resistance class 3 to Festo standard 940 070. The piston rod is made from corrosion and acid-resistant steel
	R8 Dust protection (wiper seal)	The cylinder is equipped with a hard-chrome plated piston rod and a rigid wiper seal, which protects against dry, dusty media
	TT Low temperature	Temperature resistance down to max. –40 °C

Software tools

→ www.festo.com

Configuration of Festo modular products

→ www.festo.com

Standard cylinders DNC, ISO 15552

Product range overview

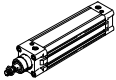
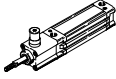
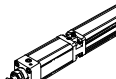
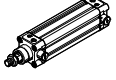
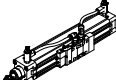
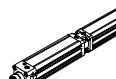
Function	Design	Type	Piston Ø	Stroke	Position sensing	Protection against rotation	Through/hollow piston rod	Extended male piston rod thread	Female piston rod thread	Special piston rod thread	
			[mm]	[mm]							A
Double-acting	Basic version										
		DNC	32, 40, 50, 63, 80, 100, 125	20, 25, 30, 40, 50, 60, 70, 80, 100, 125, 150, 160, 200, 250, 300, 320, 400, 500	10 ... 2,000	■	■	■	■	■	■
	Standard hole pattern, with clamping unit										
		DNC-KP	32, 40, 50, 63, 80, 100, 125	–	10 ... 2,000	■	■	■ S2	■	■	■
		DNCKE	40, 63, 100	–	10 ... 2,000	■	–	–	–	–	–
	Standard hole pattern, with end-position locking										
		DNC-...-EL	32, 40, 50, 63, 80, 100	–	10 ... 2,000	■	–	■ S2	■	■	■
	Standard hole pattern, cylinder/valve combination										
		DNC-V1 ... V6	32, 40, 50, 63, 80, 100	–	100 ... 2,000	■	■	■	■	■	■
	Standard hole pattern, tandem cylinder										
	DNCT	32, 40, 50	–	2 ... 500	■	–	–	–	–	–	
		63, 80, 100, 125		3 ... 500							

Standard cylinders DNC, ISO 15552

Product range overview

Type	Special spanner flats	Extended piston rod	Smooth anodised piston rod	Heat-resistant seals to max. 120 °C	Slow speed (constant motion)	Low friction	High corrosion protection	Dust protection	Low temperature	Cylinder/valve combination	→ Page/Internet
	K7	K8	K10	S6	S10	S11	R3	R8	TT	V1 ... V6	
Basic version											
DNC	■	■	■	■	■	■	■	■	■	-	9
Standard hole pattern, with clamping unit											
DNC-KP	■	■	-	-	-	-	-	-	-	■	25
DNCKE	-	-	-	-	-	-	-	-	-	-	2
Standard hole pattern, with end-position locking											
DNC-...-EL	-	■	-	-	-	-	-	-	-	-	33
Standard hole pattern, cylinder/valve combination											
DNC-V1 ... V6	■	■	■	-	■	■	-	■	-	■	40
Standard hole pattern, tandem cylinder											
DNCT	-	-	-	■	-	-	-	-	-	-	2

Standard cylinders DNC, ISO 15552

Peripherals overview

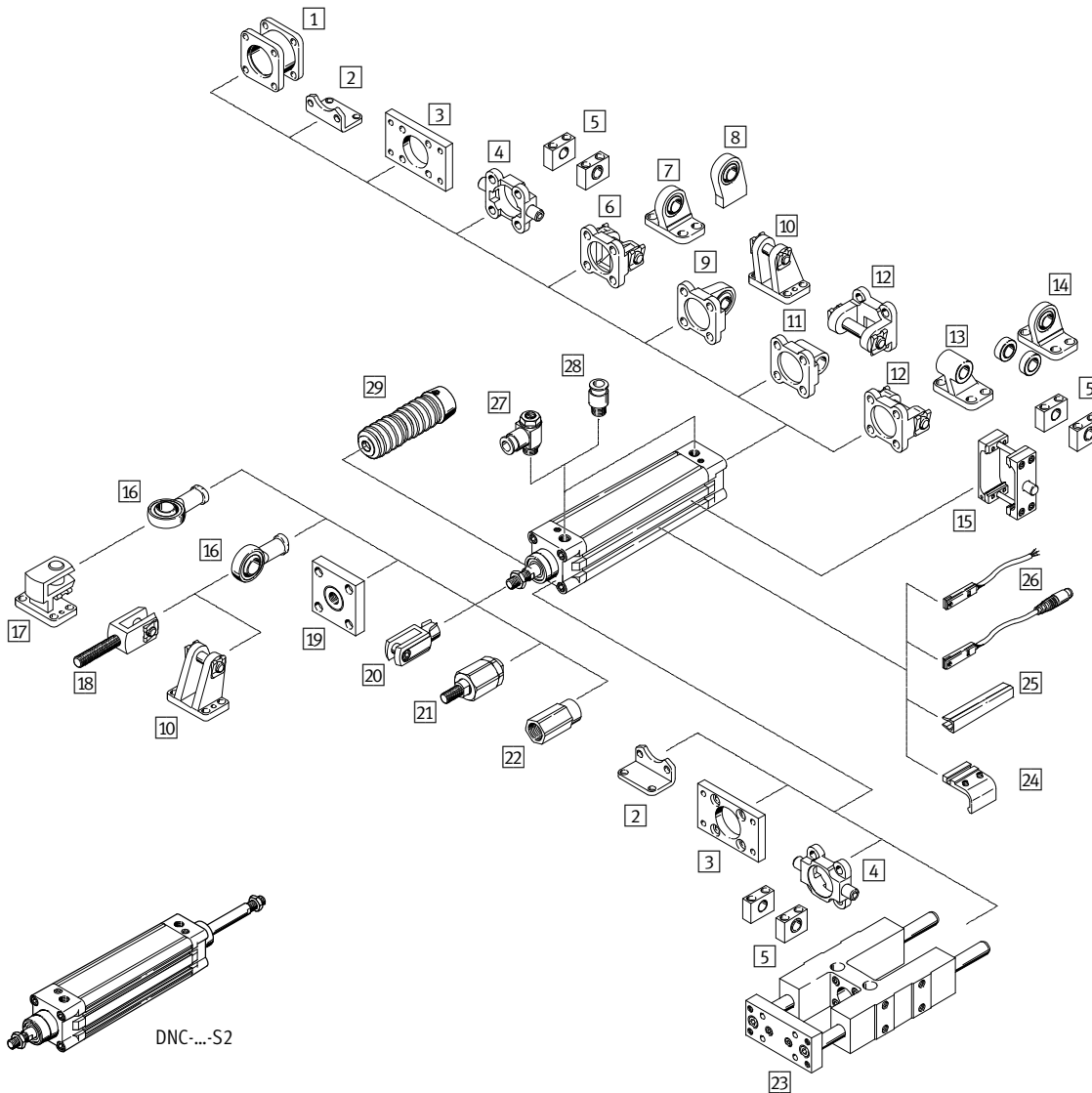

Mounting attachments and accessories							
	Brief description	DNC				→ Page/ Internet	
		Basic version	KP	EL	V1 ... V6		
1	Multi-position kit DPNC	For connecting two cylinders with identical piston diameters to form a multi-position cylinder	■ ¹⁾	■	■	■ ¹⁾	49
2	Foot mounting HNC/CRHNC	For bearing or end caps	■	■	■	■	50
3	Flange mounting FNC/CRFNG	– For bearing or end caps – Cannot be used on the bearing cap in combination with bellows kit DADB	■	■	■	■	51
4	Trunnion flange ZNCF/CRZNG	– For bearing or end caps – Cannot be used on the bearing cap in combination with bellows kit DADB	■	■	■	■	52
5	Trunnion support LNZG/CRLNZG	–	■	■	■	■	54
6	Swivel flange SNC	For end caps	■ ¹⁾	■ ¹⁾	■	■ ¹⁾	55
7	Clevis foot LSNG	With spherical bearing	■ ¹⁾	■ ¹⁾	■	■ ¹⁾	58
8	Clevis foot LSNSG	Weld-on, with spherical bearing	■ ¹⁾	■ ¹⁾	■	■ ¹⁾	58

Standard cylinders DNC, ISO 15552

Peripherals overview

Mounting attachments and accessories							
	Brief description	DNC				→ Page/ Internet	
		Basic version	KP	EL	V1 ... V6		
9	Swivel flange SNCS	With spherical bearing for end caps	■ ¹⁾	■ ¹⁾	■	■ ¹⁾	57
10	Clevis foot LBG	–	■ ¹⁾	■	■	■ ¹⁾	58
11	Swivel flange SNCL	For end caps	■ ¹⁾	■ ¹⁾	■	■ ¹⁾	57
12	Swivel flange SNCB/SNCB-...-R3	For end caps	■ ¹⁾	■ ¹⁾	■	■ ¹⁾	56
13	Clevis foot LNG/CRLNG	–	■ ¹⁾	■ ¹⁾	■	■ ¹⁾	58
14	Clevis foot LSN	With spherical bearing	■ ¹⁾	■ ¹⁾	■	■ ¹⁾	58
15	Trunnion mounting kit DAMT	For mounting anywhere along the cylinder profile barrel	■	■	■	■	53
16	Rod eye SGS/CRSGS	With spherical bearing	■	■	■	■	59
17	Right-angle clevis foot LQG	–	■	■	■	■	58
18	Rod clevis SGA	With male thread	■	■	■	■	59
19	Coupling piece KSG	To compensate for radial deviations	■	■	■	■	59
	Coupling piece KSZ	For cylinders with a non-rotating piston rod to compensate for radial deviations	■	■	■	■	59
20	Rod clevis SG/CRSG	Permits a swivelling movement of the cylinder in one plane	■	■	■	■	59
21	Self-aligning rod coupler FK/CRFK	For compensating radial and angular deviations	■	■	■	■	59
22	Adapter AD	For fitting a suction cup on a hollow cylinder piston rod	■	–	–	■	59
23	Guide unit FENG	For protecting standard cylinders against rotation at high torque loads	■	■ ∅ 50 and above	–	–	64
24	Mounting kit SMB-8-FENG	For attaching proximity sensor SMT-8 to cylinders in combination with guide unit FENG	■ ²⁾	■ ∅ 50 and above	■	–	64
25	Slot cover ABP-5-S	For protecting the sensor cables and keeping dirt out of the sensor slots	■	■	■	■	65
26	Proximity sensor SME/SMT-8	Can be integrated in the cylinder profile barrel	■	■	■	■	65
27	One-way flow control valve GRLA	For regulating speed	■	■	■	■	66
28	Push-in fitting QS	For connecting compressed air tubing with standard outside diameter	■	■	■	■	quick star
29	Bellows kit DADB	– Protects the cylinder (piston rod, seal and bearings) against a wide range of media and thus prevents premature wear – The kit can only be used in combination with an extended piston rod (K8)	■	–	■	■	60

1) Not with variant S2 or S20

2) For piston ∅ 32, 40 mm only with variant R3

Standard cylinders DNC, ISO 15552

Type codes

		DNC	–	80	–	320	–	PPV	–	A
Type										
Double-acting										
DNC	Standard cylinder									
Piston Ø [mm]										
Stroke [mm]										
Cushioning										
P	Flexible cushioning rings/pads at both ends									
PPV	Pneumatic cushioning, adjustable at both ends									
Position sensing										
	Without position sensing									
A	Via proximity sensor									

 - Note

The standard cylinder DNC can be ordered using either a fixed part number and type designation or via the modular product system. The type code listed above only applies to the DNC standard cylinder with fixed part number and type designation. Variants can only be ordered using the modular product system.

Standard cylinders DNC, ISO 15552

Technical data

Function

DNC-...

Without position sensing

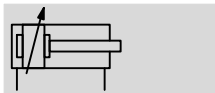
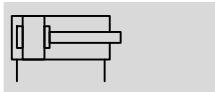

DNC-...-A-...

With position sensing

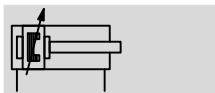
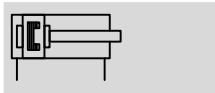

-  - Diameter
32 ... 125 mm
 -  - Stroke length
10 ... 2,000 mm
 -  - www.festo.com
- Wearing parts kits
→ 24



- Standards-based cylinders to ISO 15552 (corresponds to the withdrawn standards ISO 6431, DIN ISO 6431, VDMA 24 562, NF E 49 003.1 and UNI 10290)



General technical data							
Piston Ø	32	40	50	63	80	100	125
Pneumatic connection	G $\frac{1}{8}$	G $\frac{1}{4}$	G $\frac{1}{4}$	G $\frac{3}{8}$	G $\frac{3}{8}$	G $\frac{1}{2}$	G $\frac{1}{2}$
Piston rod thread	M10x1.25	M12x1.25	M16x1.5	M16x1.5	M20x1.5	M20x1.5	M27x2
	K3	M6	M8	M10	M10	M12	M16
	K5	M10	M12	M16	M16	M20	M27
Constructional design	Piston						
	Piston rod						
	Profile barrel						
Max. torsional backlash of piston rod [°]	Q ±0.65	±0.6	±0.45	±0.45	±0.45	±0.45	-
Cushioning	Flexible cushioning rings/pads at both ends						
	Pneumatic cushioning, adjustable at both ends						
Cushioning length PPV [mm]	20	20	22	22	32	32	42
Position sensing	Via proximity sensor						
Type of mounting	Via female thread						
	Via accessories						
Mounting position	Any						

• Note: This product conforms to ISO 1179-1 and to ISO 228-1

Standard cylinders DNC, ISO 15552

Technical data

Operating and environmental conditions								
Piston Ø	32	40	50	63	80	100	125	
Operating medium	Compressed air in accordance with ISO 8573-1:2010 [7:4:4]							
Note on operating/pilot medium	Operation with lubricated medium possible (in which case lubricated operation will always be required)							
Operating pressure [bar]	0.6 ... 12							
	R8	1.5 ... 12					0.6 ... 10	
	S11	After 10 strokes						
		0.16 ... 12		0.1 ... 12		0.06 ... 12		0.06 ... 10
		After 24 hours						
TT	1 ... 12					-		
Ambient temperature ¹⁾ [°C]	-20 ... +80							
	S6	0 ... 120						
	TT	-40 ... +80					-	
Corrosion resistance class	2							
CRC ²⁾	R3	3						
Certification	Germanischer Lloyd							
ATEX	Specified types → www.festo.com							

1) Note operating range of proximity sensors

2) Corrosion resistance class 2 as per Festo standard 940 070

Components subject to moderate corrosion stress. Externally visible parts with primarily decorative surface requirements which are in direct contact with a normal industrial environment or media such as coolants or lubricating agents.

Corrosion resistance class 3 as per Festo standard 940 070

Components requiring higher corrosion resistance. External visible parts in direct contact with industrial atmospheres or media such as solvents and cleaning agents, with a predominantly functional requirement for the surface.

Force [N] and impact energy [J]							
Piston Ø	32	40	50	63	80	100	125
Theoretical force at 6 bar, advancing	483	754	1,178	1,870	3,016	4,712	7,363
	S2/S20	415	633	990	1,682	2,721	4,418
Theoretical force at 6 bar, retracting	415	633	990	1,682	2,721	4,418	6,881
	S2/S20	415	633	990	1,682	2,721	4,418
Max. impact energy at the end positions ¹⁾	0.1	0.2	0.2	0.5	0.9	1.2	5

1) The permissible impact energy is reduced by approx. 10% for variants K10 and S20

Permissible impact velocity:

$$v_{perm.} = \sqrt{\frac{2 \times E_{perm.}}{m_{dead} + m_{load}}}$$

Maximum permissible load:

$$m_{load} = \frac{2 \times E_{perm.}}{v^2} - m_{dead}$$

$v_{perm.}$ Permissible impact velocity

$E_{perm.}$ Max. impact energy

$m_{intrinsic}$ Moving load (drive)

m_{load} Moving effective load

 Note

This data represents the maximum values that can be achieved. The maximum permissible impact energy must be observed.

Standard cylinders DNC, ISO 15552

Technical data

Lateral force F_q as a function of stroke length l

Basic version

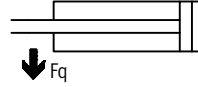
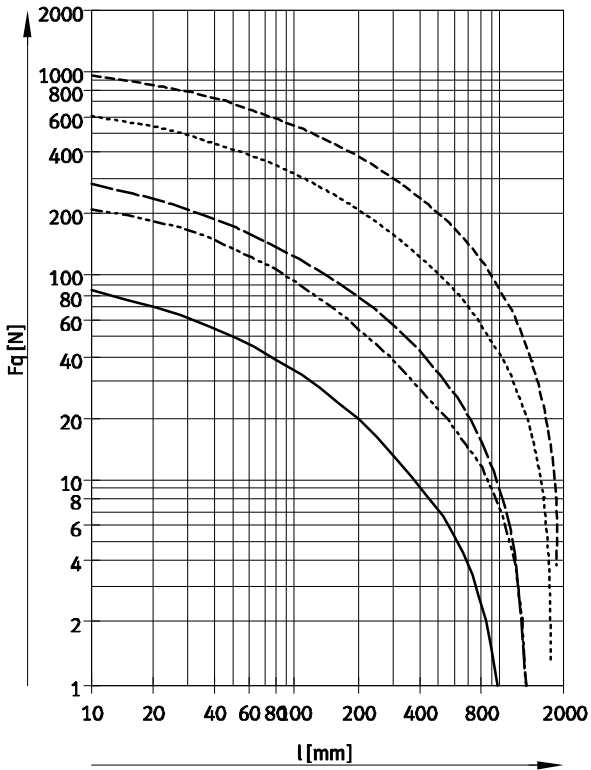

- Ø 32
- - - - - Ø 40
- — — — — Ø 50/63
- · · · · Ø 80/100
- - - - - Ø 125

Standard cylinders DNC, ISO 15552

Technical data

Lateral force F_q as a function of stroke length l and lever arm s

Q – Square piston rod

Ø 32

Max. torque = 800 Nmm / Max. stroke = 300 mm

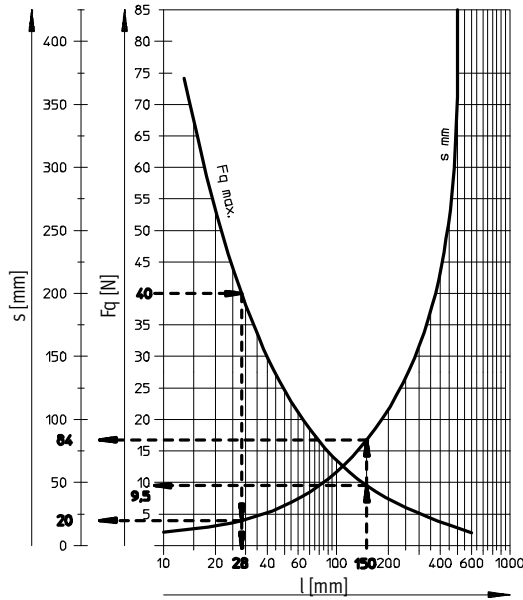

Ø 40

Max. torque = 1,100 Nmm / Max. stroke = 400 mm

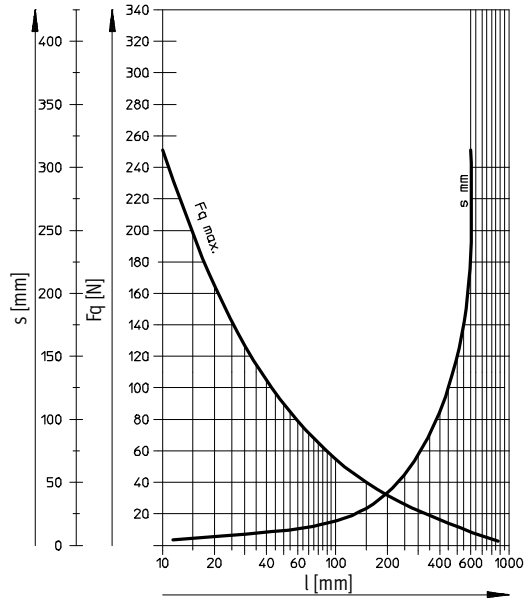

Ø 50/63

Max. torque = 1,500 Nmm / Max. stroke = 500 mm

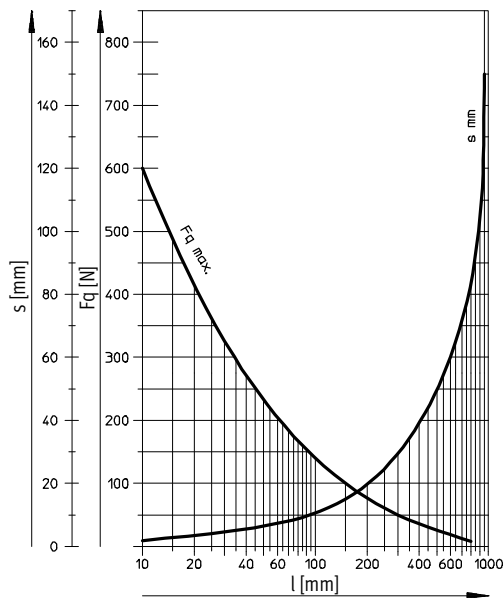

Ø 80/100

Max. torque = 3,000 Nmm / Max. stroke = 600 mm

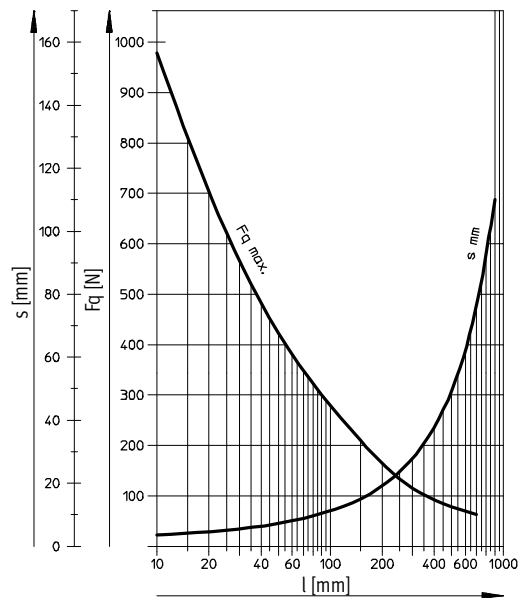

Examples for piston Ø 32 mm

Example 1:

Stroke length l = 150 mm

Result: permissible

Lateral force F_q = 9.5 N

Lever arm s = 84 mm

Example 2:

Lateral force F_q = 40 N

Result: permissible

Stroke length l = 28 mm

Lever arm s = 20 mm

Example 3:

Stroke length l = 150 mm

Lever arm s = 100 mm

$F_q = \frac{\text{Max. torque } 800 \text{ Nmm}}{\text{Lever arm } 100 \text{ mm}}$

= 8 N

Result: permissible

$F_q = 8 \text{ N} < F_{q\text{max.}} = 9.5 \text{ N}$

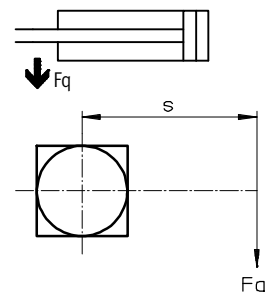

Standard cylinders DNC, ISO 15552

Technical data

Weight [g]							
Piston \varnothing	32	40	50	63	80	100	125
Basic version							
Product weight with 0 mm stroke	517	800	1,260	1,709	2,790	4,653	6,771
Additional weight per 10 mm stroke	30	45	64	73	106	115	168
Moving load with 0 mm stroke	162	307	538	663	1,131	1,544	2,809
Additional load per 10 mm stroke	9	16	25	25	38	38	63
Q – Square piston rod							
Product weight with 0 mm stroke	504	738	1,187	1,632	2,652	4,508	–
Additional weight per 10 mm stroke	29	41	60	68	99	108	–
Moving load with 0 mm stroke	149	244	465	587	994	1,399	–
Additional load per 10 mm stroke	8	11	20	20	31	31	–
S2 – Through piston rod							
Product weight with 0 mm stroke	576	895	1,390	1,917	3,114	5,297	7,529
Additional weight per 10 mm stroke	39	61	89	98	144	153	231
Moving load with 0 mm stroke	170	330	560	711	1,200	1,660	2,925
Additional load per 10 mm stroke	18	32	50	50	76	76	126
K10 – Smooth anodised piston rod							
Product weight with 0 mm stroke	443	655	1,001	1,437	2,302	4,138	5,719
Additional weight per 10 mm stroke	24	35	47	57	81	90	127
Moving load with 0 mm stroke	88	162	279	391	643	1,029	1,757
Additional load per 10 mm stroke	3	6	8	9	13	13	22
S2-K10 – Through, smooth anodised piston rod							
Product weight with 0 mm stroke	514	766	1,181	1,676	2,701	4,821	6,674
Additional weight per 10 mm stroke	27	40	56	65	94	103	148
Moving load with 0 mm stroke	108	201	351	470	787	1,184	2,070
Additional load per 10 mm stroke	6	11	17	17	26	26	43
TT – Low temperature							
Product weight with 0 mm stroke	520	876	1,279	2,112	2,972	5,039	–
Additional weight per 10 mm stroke	31	46	65	73	108	116	–
Moving load with 0 mm stroke	108	204	363	460	802	1,045	–
Additional load per 10 mm stroke	9	16	25	25	39	39	–
TT-S2 – Low temperature with through piston rod							
Product weight with 0 mm stroke	606	1,020	1,546	2,401	3,453	5,617	–
Additional weight per 10 mm stroke	40	62	89	98	147	154	–
Moving load with 0 mm stroke	169	326	573	687	1,199	1,473	–
Additional load per 10 mm stroke	18	32	49	49	77	77	–

Standard cylinders DNC, ISO 15552

Technical data

Materials

Sectional view

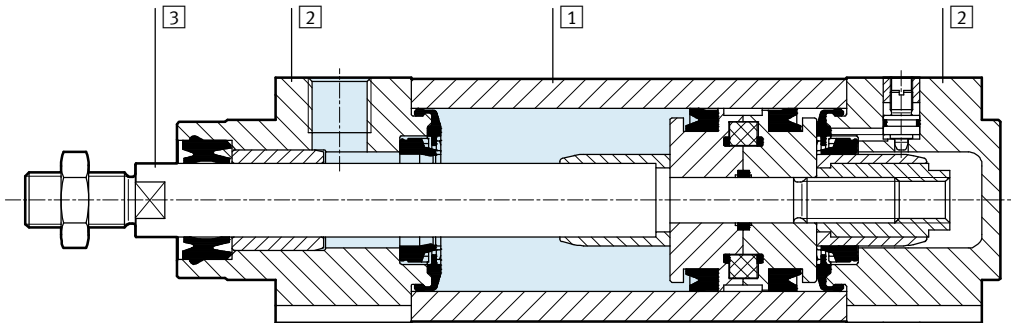

Standard cylinder	Basic version	K10	R3
1 Profile barrel	Wrought aluminium alloy, smooth anodised	Wrought aluminium alloy, smooth anodised	
2 Bearing and end caps	Die-cast aluminium		
3 Piston rod	High-alloy steel	Wrought aluminium alloy, anodised	High-alloy stainless steel
- Seals	Polyurethane, nitrile rubber		
Note on materials	RoHS compliant		

Standard cylinder	R8	S6	S10	S11	TT
1 Profile barrel	Wrought aluminium alloy, smooth anodised				
2 Bearing and end caps	Die-cast aluminium				Coated aluminium
3 Piston rod	Tempered steel, hard-chromium plated	High-alloy steel			
- Seals	Polyurethane, nitrile rubber	Fluoro rubber			Polyurethane
Note on materials	RoHS compliant				

Standard cylinders DNC, ISO 15552

Technical data

Dimensions – Basic version

Download CAD data → www.festo.com

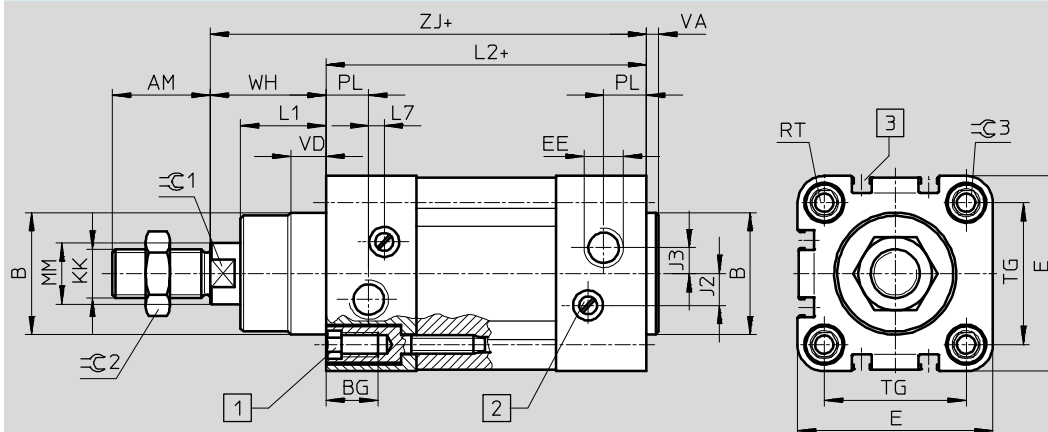

- 1** For mounting attachments:
 Ø 32 ... 100: Socket head screw with female thread
 Ø 125: Thread in the end cap
 - 2** Regulating screw for adjustable end-position cushioning
 - 3** Slot for proximity sensor SME/SMT-8
- + = plus stroke length

Ø [mm]	AM	B Ø d11	BG	E	EE	J2		J3	KK	L1	L2
							TT				
32	22	30	16	45	G1/8	6		5.2	M10x1.25	18	94
40	24	35	16	54	G1/4	8		6	M12x1.25	21.5	105
50	32	40	17	64	G1/4	10.4	11	8.5	M16x1.5	28	106
63	32	45	17	75	G3/8	12.4		10	M16x1.5	28.5	121
80	40	45	17	93	G3/8	12.5		8	M20x1.5	34.7	128
100	40	55	17	110	G1/2	12		10	M20x1.5	38.2	138
125	54	60	22	134	G1/2	13		8	M27x2	46	160

Ø [mm]	L7	MM Ø	PL	RT	TG	VA	VD	WH	ZJ	C1	C2	C3
32	3.3	12	15.6	M6	32.5	4	10	26	120	10	16	6
40	3.6	16	14	M6	38	4	10.5	30	135	13	18	6
50	5.1	20	14	M8	46.5	4	11.5	37	143	17	24	8
63	6.6	20	17	M8	56.5	4	15	37	158	17	24	8
80	10.5	25	16.4	M10	72	4	15.7	46	174	22	30	6
100	8	25	18.8	M10	89	4	19.2	51	189	22	30	6
125	14	32	18	M12	110	6	20.5	65	225	27	36	8

Note: This product conforms to ISO 1179-1 and to ISO 228-1

Standard cylinders DNC, ISO 15552

Technical data

Dimensions – Variants

Download CAD data → www.festo.com

Q – Square piston rod

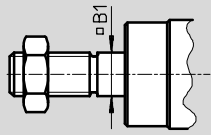

S2 – Through piston rod

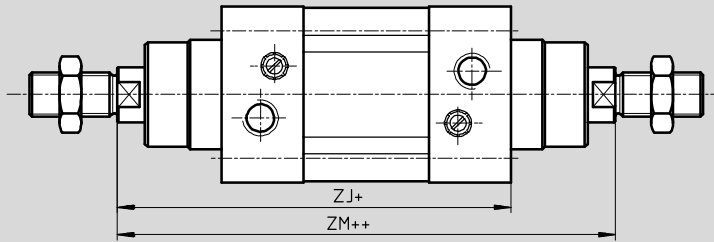

+ = plus stroke length
++ = plus 2x stroke length

S20 – Through hollow piston rod

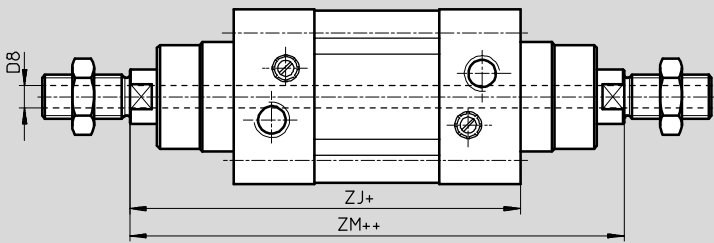

+ = plus stroke length
++ = plus 2x stroke length

∅ [mm]	B1 □	D8 ∅		ZJ	ZM	
			TT			TT
32	10	4.5	4.5	120	148	146.6
40	12	5.5	6	135	167	165.3
50	16	8 ¹⁾	8	143	183	180.3
63	16	8	8	158	199	195.9
80	20	11.7	11.7 ²⁾	174	222	221.1
100	20	11.7	11.7 ²⁾	189	240	239.7
125	–	13	–	225	291	–

1) Internal narrowing to ∅ 5.5 mm
2) Internal narrowing to ∅ 10.2 mm

Standard cylinders DNC, ISO 15552

Technical data

Dimensions – Variants

Download CAD data → www.festo.com

K2 – Extended male piston rod thread

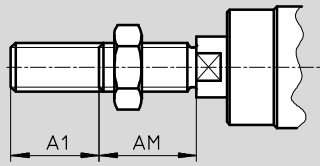

K3 – Female piston rod thread

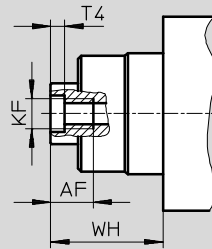

K5 – Special piston rod thread

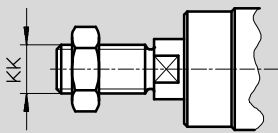

K7 – Piston rod with external hexagon

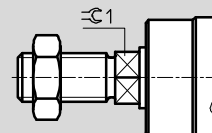

K8 – Extended piston rod

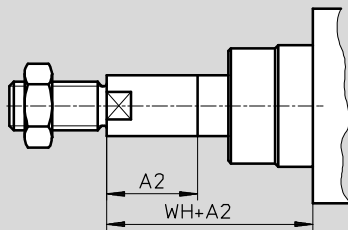

-  - Note

In combination with variant S2/S20, the piston rod is extended at one

end. In combination with variant Q, the square piston rod is extended.

∅ [mm]	A1 max.	A2 max.	AF	AM	KF	KK		T4	WH	≈1
						Basic thread	Special thread ¹⁾			
32	35	500	12	22	M6	M10x1.25	M10	2.6	26	10
40	35	500	12	24	M8	M12x1.25	M12	3.3	30	13
50	70	500	16	32	M10	M16x1.5	M16	4.7	37	17
63	70	500	16	32	M10	M16x1.5	M16	4.7	37	17
80	70	500	20	40	M12	M20x1.5	M20	6.1	46	22
100	70	500	20	40	M12	M20x1.5	M20	6.1	51	22
125	70	500	32	54	M16	M27x2	M27	8	65	27

1) The special threads are only available as male threads. The mounting nut on the piston rod thread is included in the scope of delivery

Standard cylinders DNC, ISO 15552

Technical data

Ordering data – Without position sensing							
Piston Ø [mm]	Stroke [mm]	Part No.	Type ¹⁾	Piston Ø [mm]	Stroke [mm]	Part No.	Type ¹⁾
32	25	163319	DNC-32-25-PPV	40	25	163351	DNC-40-25-PPV
	40	163320	DNC-32-40-PPV		40	163352	DNC-40-40-PPV
	50	163321	DNC-32-50-PPV		50	163353	DNC-40-50-PPV
	80	163322	DNC-32-80-PPV		80	163354	DNC-40-80-PPV
	100	163323	DNC-32-100-PPV		100	163355	DNC-40-100-PPV
	125	163324	DNC-32-125-PPV		125	163356	DNC-40-125-PPV
	160	163325	DNC-32-160-PPV		160	163357	DNC-40-160-PPV
	200	163326	DNC-32-200-PPV		200	163358	DNC-40-200-PPV
	250	163327	DNC-32-250-PPV		250	163359	DNC-40-250-PPV
	320	163328	DNC-32-320-PPV		320	163360	DNC-40-320-PPV
	400	163329	DNC-32-400-PPV		400	163361	DNC-40-400-PPV
	500	163330	DNC-32-500-PPV		500	163362	DNC-40-500-PPV
50	25	163383	DNC-50-25-PPV	63	25	163415	DNC-63-25-PPV
	40	163384	DNC-50-40-PPV		40	163416	DNC-63-40-PPV
	50	163385	DNC-50-50-PPV		50	163417	DNC-63-50-PPV
	80	163386	DNC-50-80-PPV		80	163418	DNC-63-80-PPV
	100	163387	DNC-50-100-PPV		100	163419	DNC-63-100-PPV
	125	163388	DNC-50-125-PPV		125	163420	DNC-63-125-PPV
	160	163389	DNC-50-160-PPV		160	163421	DNC-63-160-PPV
	200	163390	DNC-50-200-PPV		200	163422	DNC-63-200-PPV
	250	163391	DNC-50-250-PPV		250	163423	DNC-63-250-PPV
	320	163392	DNC-50-320-PPV		320	163424	DNC-63-320-PPV
	400	163393	DNC-50-400-PPV		400	163425	DNC-63-400-PPV
	500	163394	DNC-50-500-PPV		500	163426	DNC-63-500-PPV
80	25	163447	DNC-80-25-PPV	100	25	163479	DNC-100-25-PPV
	40	163448	DNC-80-40-PPV		40	163480	DNC-100-40-PPV
	50	163449	DNC-80-50-PPV		50	163481	DNC-100-50-PPV
	80	163450	DNC-80-80-PPV		80	163482	DNC-100-80-PPV
	100	163451	DNC-80-100-PPV		100	163483	DNC-100-100-PPV
	125	163452	DNC-80-125-PPV		125	163484	DNC-100-125-PPV
	160	163453	DNC-80-160-PPV		160	163485	DNC-100-160-PPV
	200	163454	DNC-80-200-PPV		200	163486	DNC-100-200-PPV
	250	163455	DNC-80-250-PPV		250	163487	DNC-100-250-PPV
	320	163456	DNC-80-320-PPV		320	163488	DNC-100-320-PPV
	400	163457	DNC-80-400-PPV		400	163489	DNC-100-400-PPV
	500	163458	DNC-80-500-PPV		500	163490	DNC-100-500-PPV
125	25	163511	DNC-125-25-PPV				
	40	163512	DNC-125-40-PPV				
	50	163513	DNC-125-50-PPV				
	80	163514	DNC-125-80-PPV				
	100	163515	DNC-125-100-PPV				
	125	163516	DNC-125-125-PPV				
	160	163517	DNC-125-160-PPV				
	200	163518	DNC-125-200-PPV				
	250	163519	DNC-125-250-PPV				
	320	163520	DNC-125-320-PPV				
	400	163521	DNC-125-400-PPV				
	500	163522	DNC-125-500-PPV				

1) The mounting nut on the piston rod thread is included in the scope of delivery

Standard cylinders DNC, ISO 15552

Technical data

Ordering data – With position sensing							
Piston Ø [mm]	Stroke [mm]	Part No.	Type ¹⁾	Piston Ø [mm]	Stroke [mm]	Part No.	Type ¹⁾
32	20	1922617	DNC-32-20-PPV-A	40	20	1922623	DNC-40-20-PPV-A
	25	163305	DNC-32-25-PPV-A		25	163337	DNC-40-25-PPV-A
	30	1922618	DNC-32-30-PPV-A		30	1922624	DNC-40-30-PPV-A
	40	163306	DNC-32-40-PPV-A		40	163338	DNC-40-40-PPV-A
	50	163307	DNC-32-50-PPV-A		50	163339	DNC-40-50-PPV-A
	60	1922619	DNC-32-60-PPV-A		60	1922625	DNC-40-60-PPV-A
	70	1922620	DNC-32-70-PPV-A		70	1922626	DNC-40-70-PPV-A
	80	163308	DNC-32-80-PPV-A		80	163340	DNC-40-80-PPV-A
	100	163309	DNC-32-100-PPV-A		100	163341	DNC-40-100-PPV-A
	125	163310	DNC-32-125-PPV-A		125	163342	DNC-40-125-PPV-A
	150	1922621	DNC-32-150-PPV-A		150	1922627	DNC-40-150-PPV-A
	160	163311	DNC-32-160-PPV-A		160	163343	DNC-40-160-PPV-A
	200	163312	DNC-32-200-PPV-A		200	163344	DNC-40-200-PPV-A
	250	163313	DNC-32-250-PPV-A		250	163345	DNC-40-250-PPV-A
	300	1922622	DNC-32-300-PPV-A		300	1922628	DNC-40-300-PPV-A
	320	163314	DNC-32-320-PPV-A		320	163346	DNC-40-320-PPV-A
400	163315	DNC-32-400-PPV-A	400	163347	DNC-40-400-PPV-A		
500	163316	DNC-32-500-PPV-A	500	163348	DNC-40-500-PPV-A		
50	20	1922629	DNC-50-20-PPV-A	63	20	1922635	DNC-63-20-PPV-A
	25	163369	DNC-50-25-PPV-A		25	163401	DNC-63-25-PPV-A
	30	1922630	DNC-50-30-PPV-A		30	1922636	DNC-63-30-PPV-A
	40	163370	DNC-50-40-PPV-A		40	163402	DNC-63-40-PPV-A
	50	163371	DNC-50-50-PPV-A		50	163403	DNC-63-50-PPV-A
	60	1922631	DNC-50-60-PPV-A		60	1922637	DNC-63-60-PPV-A
	70	1922632	DNC-50-70-PPV-A		70	1922638	DNC-63-70-PPV-A
	80	163372	DNC-50-80-PPV-A		80	163404	DNC-63-80-PPV-A
	100	163373	DNC-50-100-PPV-A		100	163405	DNC-63-100-PPV-A
	125	163374	DNC-50-125-PPV-A		125	163406	DNC-63-125-PPV-A
	150	1922633	DNC-50-150-PPV-A		150	1922639	DNC-63-150-PPV-A
	160	163375	DNC-50-160-PPV-A		160	163407	DNC-63-160-PPV-A
	200	163376	DNC-50-200-PPV-A		200	163408	DNC-63-200-PPV-A
	250	163377	DNC-50-250-PPV-A		250	163409	DNC-63-250-PPV-A
	300	1922634	DNC-50-300-PPV-A		300	1922640	DNC-63-300-PPV-A
	320	163378	DNC-50-320-PPV-A		320	163410	DNC-63-320-PPV-A
400	163379	DNC-50-400-PPV-A	400	163411	DNC-63-400-PPV-A		
500	163380	DNC-50-500-PPV-A	500	163412	DNC-63-500-PPV-A		

1) The mounting nut on the piston rod thread is included in the scope of delivery

Standard cylinders DNC, ISO 15552

Technical data

Ordering data – With position sensing			
Piston Ø [mm]	Stroke [mm]	Part No.	Type ¹⁾
80	20	1922641	DNC-80-20-PPV-A
	25	163433	DNC-80-25-PPV-A
	30	1922642	DNC-80-30-PPV-A
	40	163434	DNC-80-40-PPV-A
	50	163435	DNC-80-50-PPV-A
	60	1922643	DNC-80-60-PPV-A
	70	1922644	DNC-80-70-PPV-A
	80	163436	DNC-80-80-PPV-A
	100	163437	DNC-80-100-PPV-A
	125	163438	DNC-80-125-PPV-A
	150	1922645	DNC-80-150-PPV-A
	160	163439	DNC-80-160-PPV-A
	200	163440	DNC-80-200-PPV-A
	250	163441	DNC-80-250-PPV-A
	300	1922646	DNC-80-300-PPV-A
320	163442	DNC-80-320-PPV-A	
400	163443	DNC-80-400-PPV-A	
500	163444	DNC-80-500-PPV-A	
100	25	163465	DNC-100-25-PPV-A
	40	163466	DNC-100-40-PPV-A
	50	163467	DNC-100-50-PPV-A
	80	163468	DNC-100-80-PPV-A
	100	163469	DNC-100-100-PPV-A
	125	163470	DNC-100-125-PPV-A
	160	163471	DNC-100-160-PPV-A
	200	163472	DNC-100-200-PPV-A
	250	163473	DNC-100-250-PPV-A
	320	163474	DNC-100-320-PPV-A
400	163475	DNC-100-400-PPV-A	
500	163476	DNC-100-500-PPV-A	
125	25	163497	DNC-125-25-PPV-A
	40	163498	DNC-125-40-PPV-A
	50	163499	DNC-125-50-PPV-A
	80	163500	DNC-125-80-PPV-A
	100	163501	DNC-125-100-PPV-A
	125	163502	DNC-125-125-PPV-A
	160	163503	DNC-125-160-PPV-A
	200	163504	DNC-125-200-PPV-A
	250	163505	DNC-125-250-PPV-A
	320	163506	DNC-125-320-PPV-A
	400	163507	DNC-125-400-PPV-A
	500	163508	DNC-125-500-PPV-A

1) The mounting nut on the piston rod thread is included in the scope of delivery

Standard cylinders DNC, ISO 15552

Technical data

Ordering data – Variable stroke			
Piston Ø [mm]	Stroke [mm]	Without position sensing	
		Part No.	Type ¹⁾
32	10 ... 2 000	163318	DNC-32-...-PPV
40	10 ... 2 000	163350	DNC-40-...-PPV
50	10 ... 2 000	163382	DNC-50-...-PPV
63	10 ... 2 000	163414	DNC-63-...-PPV
80	10 ... 2 000	163446	DNC-80-...-PPV
100	10 ... 2 000	163478	DNC-100-...-PPV
125	10 ... 2 000	163510	DNC-125-...-PPV

1) The mounting nut on the piston rod thread is included in the scope of delivery

Ordering data – Variable stroke			
Piston Ø [mm]	Stroke [mm]	With position sensing	
		Part No.	Type ¹⁾
32	10 ... 2 000	163304	DNC-32-...-PPV-A
40	10 ... 2 000	163336	DNC-40-...-PPV-A
50	10 ... 2 000	163368	DNC-50-...-PPV-A
63	10 ... 2 000	163400	DNC-63-...-PPV-A
80	10 ... 2 000	163432	DNC-80-...-PPV-A
100	10 ... 2 000	163464	DNC-100-...-PPV-A
125	10 ... 2 000	163496	DNC-125-...-PPV-A

1) The mounting nut on the piston rod thread is included in the scope of delivery

Standard cylinders DNC, ISO 15552

Ordering data – Modular products

M Mandatory data				O Options →						
Module No.	Function		Stroke		Position sensing		Type of piston rod		Female thread	
	Piston Ø		Cushioning		Protection against rotation		Extended male thread		Special thread	
163 302	DNC	32	10 ... 2,000	P	A	Q	S2	...K2	K3	...K5
163 334		40		PPV			S20			
163 366		50								
163 398		63								
163 430		80								
163 462		100								
163 494		125								
Order example										
163 430	DNC	- 80	- 550	- PPV	- A	- Q	- S2	-	- K3	-

Ordering table											
Size	32	40	50	63	80	100	125	Condi- tions	Code	Enter code	
M Module No.	163 302	163 334	163 366	163 398	163 430	163 462	163 494				
Function	Standard cylinder, double-acting, based on ISO 15552								DNC	DNC	
Piston Ø [mm]	32	40	50	63	80	100	125		-...		
Stroke [mm]	10 ... 2,000									-...	
Cushioning	Flexible cushioning rings/pads at both ends									-P	
	Pneumatic cushioning, adjustable at both ends								15	-PPV	
O Position sensing	Via proximity sensor									-A	
Protection against rotation	Square piston rod								2	-Q	
Type of piston rod	Through piston rod								3	-S2	
	Through, hollow piston rod								4	-S20	
Extended male thread [mm]	Piston rod with extended male thread								5	-...K2	
	1 ... 35				1 ... 70						
Female thread	Piston rod with female thread								6	-K3	
	(M6)	(M8)	(M10)	(M10)	(M12)	(M12)	(M16)				
Special thread	Piston rod with special thread								7	-...K5	
	M10	M12	M16	M16	M20	M20	M27				

15 PPV For piston Ø 125 not with S11

2 Q Max. stroke: 10 ... 1,500 mm.
In combination with S2: square piston rod at bearing cap end only.
Not with S20, K7, K10, S10, S11, R8

3 S2 In combination with K2: thread extended at both ends.
In combination with K3: female thread at both ends.
In combination with K5: special thread at both ends.
In combination with K8: piston rod extended at bearing cap end only.
Not with K7, S10, S11

4 S20 Max. stroke: 850 mm.
In combination with K8: piston rod extended end only.
Not with K2, K3, K5, K10, S6, S10, S11, R8

5 K2 Not with K3, K10

6 K3 With K5: on request.
Not with K7

7 K5 Not with K10

Transfer order code

Standard cylinders DNC, ISO 15552

Ordering data – Modular products

→ Options

Special spanner flats		Improved running performance		Low temperature		Running characteristics		Wiper seal
Extended piston rod		Temperature resistance		Slow speed (constant motion)		Corrosion protection		
K7	...K8	K10	S6	TT	S10	S11	R3	R8
-	-	-	-	-	-	-	-	-
	100K8							

Ordering table										
Size	32	40	50	63	80	100	125	Condi- tions	Code	Enter code
↓ <input type="checkbox"/> Special spanner flats	Piston rod with external hexagon							<input type="checkbox"/> 8	-K7	
<input type="checkbox"/> Extended piston rod	Extended piston rod									
	[mm] 1 ... 500								-...K8	
Improved running performance	Smooth anodised aluminium coated piston rod						-	<input type="checkbox"/> 9	-K10	
Temperature resistance	Heat-resistant seals for temperatures up to 120 °C							<input type="checkbox"/> 10	-S6	
Low temperature [°C]	-40 ... +80						-	<input type="checkbox"/> 11	-TT	
Slow speed (constant motion)	Slow speed (constant motion at low piston speeds)						-	<input type="checkbox"/> 12	-S10	
Running characteristics	Low friction							<input type="checkbox"/> 13	-S11	
Corrosion protection	High corrosion protection							<input type="checkbox"/> 14	-R3	
Wiper seal	Dust protection								-R8	

- K7** Not with Q, S2, K10
- K10** Max. stroke: 1,000 mm.
Not with S6, R3, R8
- S6** Not with S10, S11, R8
- TT** Not with P, Q, K7, K10, S6, S10, S11, R8

- S10** Max. stroke: 500 mm; additional strokes on request.
Not with S11, R3, R8
- S11** Max. stroke: 500 mm; additional strokes on request.
Not with R3, R8
- CT, R3** Not with R8

Transfer order code

- - - - - - - - - -

Standard cylinders DNC, ISO 15552

Ordering data

Wearing parts kits			
	Part No.	Type	
Piston Ø	Basic version		S6 – Heat-resistant seals up to max. 120 °C
32	369 195	DNC-32-...-PPV-(A)	384 214 DNC-32-...-PPV-(A)-S6
40	369 196	DNC-40-...-PPV-(A)	384 215 DNC-40-...-PPV-(A)-S6
50	369 197	DNC-50-...-PPV-(A)	384 216 DNC-50-...-PPV-(A)-S6
63	369 198	DNC-63-...-PPV-(A)	384 217 DNC-63-...-PPV-(A)-S6
80	369 199	DNC-80-...-PPV-(A)	384 218 DNC-80-...-PPV-(A)-S6
100	369 200	DNC-100-...-PPV-(A)	384 219 DNC-100-...-PPV-(A)-S6
125	369 201	DNC-125-...-PPV-(A)	384 220 DNC-125-...-PPV-(A)-S6

Standard cylinders DNC-KP, standard hole pattern, with clamping unit

Technical data

Function

DNC-...-KP

Without position sensing

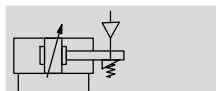
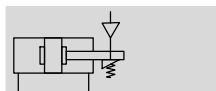

DNC-...-A-...-KP

With position sensing

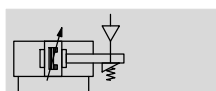
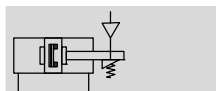

- - Diameter
32 ... 125 mm
- - Stroke length
10 ... 2,000 mm
- - www.festo.com

Wearing parts kits
→ 32



- - Note

Additional measures are required for use in safety-related applications; in Europe, for example, the standards listed under the EC Machinery Directive must be observed. Without additional measures in accordance with statutory minimum requirements, the product is not suitable for use in safety-related sections of control systems.

General technical data		32	40	50	63	80	100	125
Piston \varnothing	Cylinder	G $\frac{1}{8}$	G $\frac{1}{4}$	G $\frac{1}{4}$	G $\frac{3}{8}$	G $\frac{3}{8}$	G $\frac{1}{2}$	G $\frac{1}{2}$
	KP	M5	G $\frac{1}{8}$	G $\frac{1}{8}$	G $\frac{1}{8}$	G $\frac{1}{8}$	G $\frac{1}{8}$	G $\frac{1}{8}$
Piston rod thread		M10x1.25	M12x1.25	M16x1.5	M16x1.5	M20x1.5	M20x1.5	M27x2
	K3	M6	M8	M10	M10	M12	M12	M16
	K5	M10	M12	M16	M16	M20	M20	M27
Axial play under load	[mm]	0.5		0.8		1.8		
Constructional design	Piston							
	Piston rod							
	Profile barrel							
	Clamping unit							
Cushioning		Flexible cushioning rings/pads at both ends						
		Pneumatic cushioning, adjustable at both ends						
Cushioning length PPV	[mm]	20	20	22	22	32	32	42
Position sensing		Via proximity sensor						
Type of mounting		Via female thread						
		Via accessories						
Mounting position		Any						
Clamping type with effective direction		At both ends						

- - Note: This product conforms to ISO 1179-1 and to ISO 228-1

Operating and environmental conditions	
Operating medium	Compressed air in accordance with ISO 8573-1:2010 [7:4:4]
Note on operating/pilot medium	Operation with lubricated medium possible (in which case lubricated operation will always be required)
Operating pressure [bar]	1.5 ... 10
Min. release pressure [bar]	3
Ambient temperature ¹⁾ [°C]	-10 ... +80
Corrosion resistance class CRC ²⁾	2
Certification	Germanischer Lloyd

1) Note operating range of proximity sensors

2) Corrosion resistance class 2 as per Festo standard 940 070

Components subject to moderate corrosion stress. Externally visible parts with primarily decorative surface requirements which are in direct contact with a normal industrial environment or media such as coolants or lubricating agents.

Standard cylinders DNC-KP, standard hole pattern, with clamping unit

Technical data

Impact energy [J]							
Piston Ø	32	40	50	63	80	100	125
Max. impact energy at the end positions	0.1	0.2	0.2	0.5	0.9	1.2	5

Permissible impact velocity:

$$v_{perm.} = \sqrt{\frac{2 \times E_{perm.}}{m_{dead} + m_{load}}}$$

$v_{perm.}$ Permissible impact velocity
 $E_{perm.}$ Max. impact energy
 $m_{intrinsic}$ Moving load (drive)
 m_{load} Moving effective load

- Note
 This data represents the maximum values that can be achieved. The maximum permissible impact energy must be observed.

Maximum permissible load:

$$m_{load} = \frac{2 \times E_{perm.}}{v^2} - m_{dead}$$

Forces [N]							
Piston Ø	32	40	50	63	80	100	125
Theoretical force at 6 bar, advancing		483	754	1,178	1,870	3,016	4,712
	S2	415	633	990	1,682	2,721	4,418
Theoretical force at 6 bar, retracting		415	633	990	1,682	2,721	4,418
	S2	415	633	990	1,682	2,721	4,418
Static holding force		600	1,000	1,400	2,000	5,000	7,500

- Note
 The specified holding force refers to a static load. If this value is exceeded, slippage may occur. Dynamic forces occurring during operation must not exceed the static holding force. The clamping unit is not backlash-free in the clamped condition if varying loads are applied to the piston rod.

Activation:
 The clamping unit may only be released if the forces at the piston have reached equilibrium. Otherwise, there is a risk of accidents due to sudden movement of the piston rod. Blocking off the air supply at both ends (e.g. with a 5/3-way valve) does not provide any safety.

Standard cylinders DNC-KP, standard hole pattern, with clamping unit

Technical data

Max. lateral force F_q as a function of stroke length l

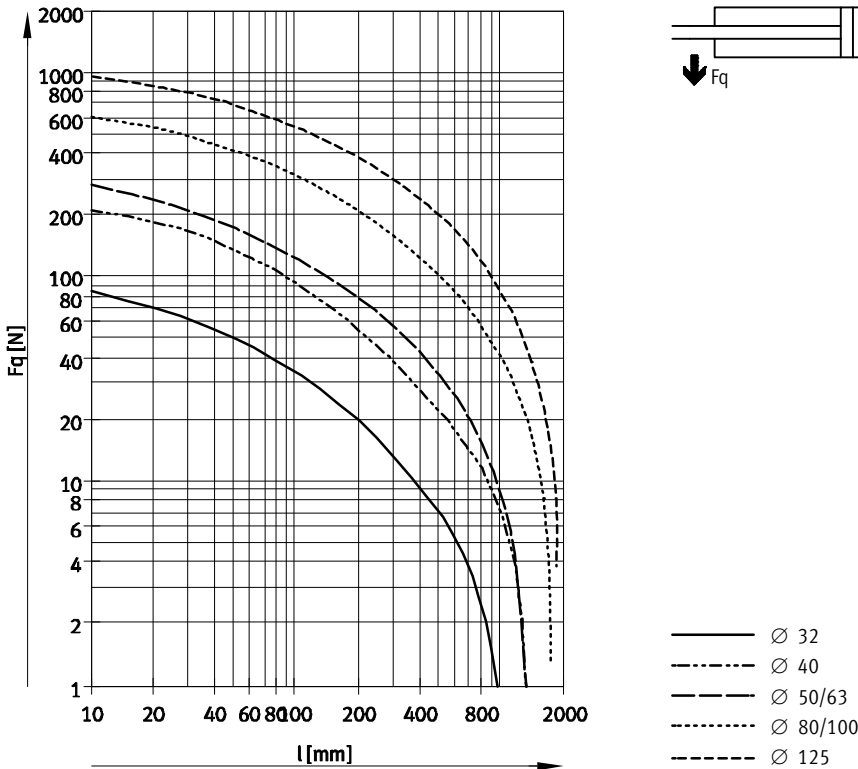

Materials

Sectional view

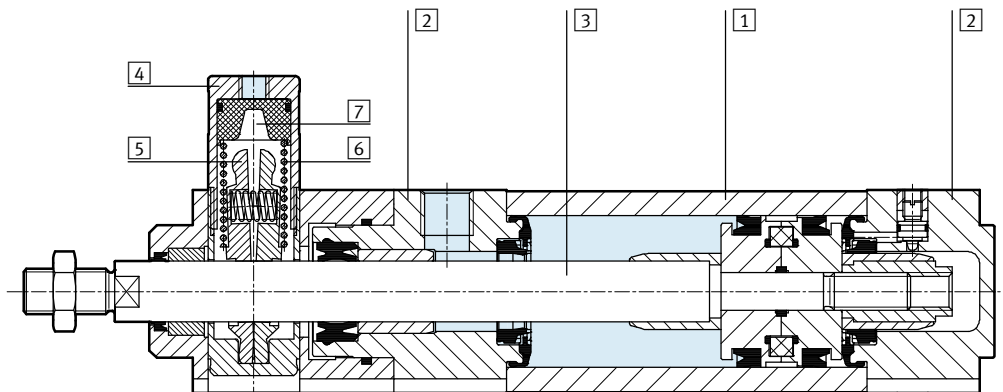

Standard cylinder		
1	Profile barrel	Wrought aluminium alloy, smooth anodised
2	Bearing and end caps	Die-cast aluminium
3	Piston rod	High-alloy steel
4	Housing, clamping unit	Wrought aluminium alloy, anodised
5	Clamping jaws	Brass
6	Spring	Spring steel
7	Piston	Polyacetal
-	Seals	Polyurethane, nitrile rubber
Note on materials		RoHS compliant

Standard cylinders DNC-KP, standard hole pattern, with clamping unit

Technical data

Dimensions – Basic version

Download CAD data → www.festo.com

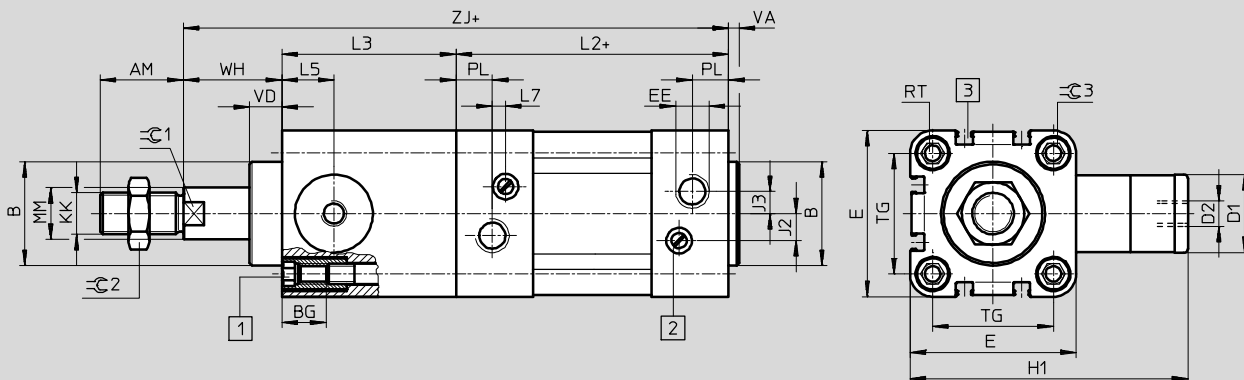

- 1 For mounting attachments:
 Ø 32 ... 100: Socket head screw with female thread
 Ø 125: Thread in the end cap
 - 2 Regulating screw for adjustable end-position cushioning
 - 3 Slot for proximity sensor SME/SMT-8
- + = plus stroke length

Ø	AM	B Ø d11	BG	D1 Ø f9	D2	E	EE	H1	J2	J3	KK	L2	L3
32	22	30	16	20	M5	45	G1/8	67	6	5.2	M10x1.25	94	45
40	24	35	16	24	G1/8	54	G1/4	88	8	6	M12x1.25	105	53
50	32	40	17	30	G1/8	64	G1/4	107	10.4	8.5	M16x1.5	106	67
63	32	45	17	38	G1/8	75	G3/8	123	12.4	10	M16x1.5	121	76
80	40	45	17	48	G1/8	93	G3/8	165.5	12.5	8	M20x1.5	128	95
100	40	55	17	48	G1/8	110	G1/2	174	12	10	M20x1.5	138	98
125	54	60	22	65	G1/8	134	G1/2	207	13	8	M27x2	160	125

Ø	L5	L7	MM Ø	PL	RT	TG	VA	VD	WH	ZJ	C1	C2	C3
32	14	3.3	12	15.6	M6	32.5	4	11.5	26	165	10	16	6
40	16	3.6	16	14	M6	38	4	11.5	30	188	13	18	6
50	20	5.1	20	14	M8	46.5	4	11	37	210	17	24	8
63	24	6.6	20	17	M8	56.5	4	11	37	234	17	24	8
80	31.5	10.5	25	16.4	M10	72	4	12.5	46	269	22	30	6
100	31	8	25	18.8	M10	89	4	12	51	287	22	30	6
125	42	14	32	18	M12	110	6	27.5	65	350	27	36	8

Note: This product conforms to ISO 1179-1 and to ISO 228-1

Note
 The dimensions for the cylinder/
 valve combination are on page
 → 44

Standard cylinders DNC-KP, standard hole pattern, with clamping unit

Technical data

Dimensions – Variants

Download CAD data → www.festo.com

Q – Square piston rod

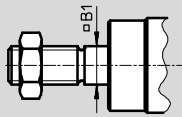

- - Note

Clamping unit and variant Q only in combination with S2.

S2 – Through piston rod

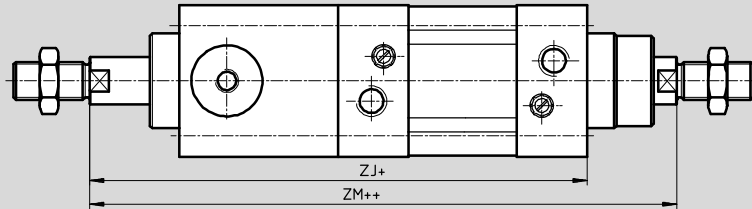

+ = plus stroke length
++ = plus 2x stroke length

- - Note

The thread types at both piston rod ends are identical.

In combination with variant Q, the left-hand piston rod is round,

the right-hand piston rod square. The clamping unit is mounted on

the left-hand, round piston rod.

K2 – Extended male piston rod thread

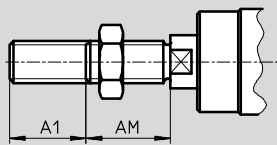

K3 – Female piston rod thread

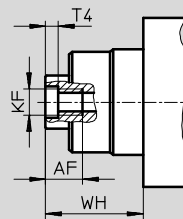

K5 – Special piston rod thread

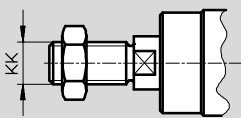

K7 – Piston rod with external hexagon

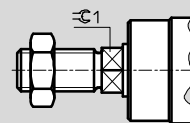

K8 – Extended piston rod

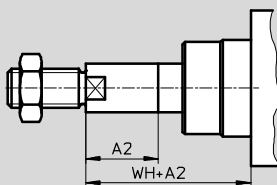

- - Note

In combination with variant S2, the piston rod is extended at one end. The clamping unit is mounted on the

side of the piston rod that is not extended. If variant Q is also required,

the extension will only be added to the square piston rod.

∅ [mm]	A1 max.	A2 max.	AF	AM	B1 □	KF	KK		T4	WH	ZJ	ZM	C1
							Basic thread	Special thread ¹⁾					
32	35	500	12	22	10	M6	M10x1.25	M10	2.6	26	165	193	10
40	35	500	12	24	12	M8	M12x1.25	M12	3.3	30	188	220	13
50	70	500	16	32	16	M10	M16x1.5	M16	4.7	37	210	250	17
63	70	500	16	32	16	M10	M16x1.5	M16	4.7	37	234	275	17
80	70	500	20	40	20	M12	M20x1.5	M20	6.1	46	269	317	22
100	70	500	20	40	20	M12	M20x1.5	M20	6.1	51	287	338	22
125	70	500	32	54	-	M16	M27x2	M27	8	65	350	416	27

1) The special threads are only available as male threads. The mounting nut on the piston rod thread is included in the scope of delivery

Standard cylinders DNC-KP, standard hole pattern, with clamping unit

Ordering data – Modular products

M Mandatory data					O Options		
Module No.	Function	Piston Ø	Stroke	Cushioning	Position sensing	Protection against rotation	Type of piston rod
163 302	DNC	32	10 ... 2,000	P PPV	A	Q	S2
163 334							
163 366							
163 398							
163 430							
163 462							
163 494							
Order example							
163 430	DNC	- 80	- 550	- PPV	- A	- Q	- S2

Ordering table										
Size	32	40	50	63	80	100	125	Condi- tions	Code	Enter code
M Module No.	163 302	163 334	163 366	163 398	163 430	163 462	163 494			
Function	Standard cylinder, double-acting, standard hole pattern, with clamping unit								DNC	DNC
Piston Ø [mm]	32	40	50	63	80	100	125		-...	
Stroke [mm]	10 ... 2,000								-...	
Cushioning	Flexible cushioning rings/pads at both ends								-P	
	Pneumatic cushioning, adjustable at both ends								-PPV	
O Position sensing	Via proximity sensor								-A	
Protection against rotation	Square piston rod						-	[1]	-Q	
↓ Type of piston rod	Through piston rod								[2]	-S2

[1] Q Max. stroke: 10 ... 1,500 mm
 In combination with S2: square piston rod at bearing cap end only
 In combination with KP: only supplied with S2
 Not with K7

[2] S2 In combination with K2: extended thread at both ends
 In combination with K3: female thread at both ends
 In combination with K5: special thread at both ends
 In combination with K8: piston rod extended at bearing cap end only
 In combination with KP: clamping unit at end cap
 Not with K7

Transfer order code

- - - - - -

Standard cylinders DNC-KP, standard hole pattern, with clamping unit

Ordering data – Modular products

→ <input type="checkbox"/> Options					<input type="checkbox"/> M	<input type="checkbox"/> 0
Extended male thread	Female thread	Special thread	Special spanner flats	Extended piston rod	Clamping unit	Cylinder/valve combination
...K2	K3	...K5	K7	...K8	KP	V1 V2 V3 V4 V5 V6
-	- K3 -	-	-	- 100K8 -	- KP -	-

Ordering table											
Size	32	40	50	63	80	100	125	Condi- tions	Code	Enter code	
<input type="checkbox"/> Extended male thread	Piston rod with extended male thread										
<input type="checkbox"/> [mm]	1 ... 35		1 ... 70					<input type="checkbox"/> 3	-...K2		
<input type="checkbox"/> Female thread	Piston rod with female thread										
	(M6)	(M8)	(M10)	(M10)	(M12)	(M12)	(M16)	<input type="checkbox"/> 4	-K3		
<input type="checkbox"/> Special thread	Piston rod with special thread										
	M10	M12	M16	M16	M20	M20	M27		-...K5		
<input type="checkbox"/> Special spanner flats	Piston rod with external hexagon									-K7	
<input type="checkbox"/> Extended piston rod	Extended piston rod										
<input type="checkbox"/> [mm]	1 ... 500									-...K8	
<input type="checkbox"/> M Clamping unit	Attached								<input type="checkbox"/> 5	-KP	-KP
<input type="checkbox"/> 0 Cylinder/valve combination	Single solenoid valve, fitted on right, piston rod retracted when unactuated							-	<input type="checkbox"/> 6	-V1	
	Single solenoid valve, fitted on right, piston rod advanced when unactuated							-	<input type="checkbox"/> 6	-V2	
	Double solenoid valve, fitted on right							-	<input type="checkbox"/> 6	-V3	
	Single solenoid valve, fitted on left, piston rod retracted when unactuated							-	<input type="checkbox"/> 6	-V4	
	Single solenoid valve, fitted on left, piston rod advanced when unactuated							-	<input type="checkbox"/> 6	-V5	
	Double solenoid valve, fitted on left							-	<input type="checkbox"/> 6	-V6	

3 **K2** Not with K3
 4 **K3** With K5: on request
 Not with K7

5 **KP** Without S2: position of the clamping unit at the bearing cap
 6 **V...** Min. stroke: 100 mm

Transfer order code

- - - - - - - -

Standard cylinders DNC-KP, standard hole pattern, with clamping unit

Ordering data

Wearing parts kits		
	Part No.	Type
Piston Ø	Basic version	
32	369 195	DNC-32-...-PPV-(A)
40	369 196	DNC-40-...-PPV-(A)
50	369 197	DNC-50-...-PPV-(A)
63	369 198	DNC-63-...-PPV-(A)
80	369 199	DNC-80-...-PPV-(A)
100	369 200	DNC-100-...-PPV-(A)
125	369 201	DNC-125-...-PPV-(A)

Standard cylinders DNC-EL, standard hole pattern, with end-position locking

Technical data

Function

DNC-...-A-...-EL

With position sensing

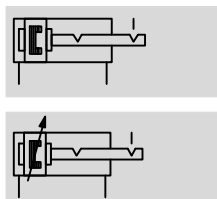

⌀ - Diameter
32 ... 100 mm

▬ - Stroke length
10 ... 2,000 mm

 www.festo.com

Wearing parts kits
→ 24



 Note

Additional measures are required for use in safety-related applications; in Europe, for example, the standards listed under the EC Machinery Directive must be observed. Without

additional measures in accordance with statutory minimum requirements, the product is not suitable for use in safety-related sections of control systems.

General technical data		32	40	50	63	80	100
Piston ⌀		32	40	50	63	80	100
Pneumatic connection		G $\frac{1}{8}$	G $\frac{1}{4}$	G $\frac{1}{4}$	G $\frac{3}{8}$	G $\frac{3}{8}$	G $\frac{1}{2}$
Piston rod thread		M10x1.25	M12x1.25	M16x1.5	M16x1.5	M20x1.5	M20x1.5
Max. axial backlash with end position locked	[mm]	≤ 1.3				≤ 2.1	
Constructional design		Piston					
		Piston rod					
		Profile barrel					
End-position locking	ELB	At both ends					
	ELV	At front					
	ELH	At rear					
Cushioning		Flexible cushioning rings/pads at both ends					
		Pneumatic cushioning, adjustable at both ends					
Cushioning length PPV [mm]		20	20	22	22	32	32
	EL	8.2	8.3	7.3	10.8	9.8	11.8
Position sensing		Via proximity sensor					
Type of mounting		Via female thread					
		Via accessories					
Mounting position		Any					

 Note: This product conforms to ISO 1179-1 and to ISO 228-1

 Note

- End-position locking should only be operated in conjunction with double-acting cylinders with exhaust air flow control in order to ensure that the lock is always completely released prior to starting the drive movement.
- No screws with a head or similar may be used in place of end-position locking, as there is a risk that the function will be impaired if they are screwed in too deeply.
- The exhaust hole must not be closed.
- Locking can be performed from any stroke position once the drive is brought mechanically into its end position.
- End-position locking has been designed to prevent the load dropping in case of pressure failure.
- An excessive end-position cushioning setting (more than 50% closed) can result in the locking bolt not engaging reliably, resulting in premature wear.

Standard cylinders DNC-EL, standard hole pattern, with end-position locking

Technical data

Operating and environmental conditions						
Piston Ø	32	40	50	63	80	100
Operating medium	Compressed air in accordance with ISO 8573-1:2010 [7:4:4]					
Note on operating/pilot medium	Operation with lubricated medium possible (in which case lubricated operation will always be required)					
Operating pressure [bar]	2.5 ... 12		1.5 ... 12			
Ambient temperature ¹⁾ [°C]	-20 ... +80					
Corrosion resistance class CRC ²⁾	2					
Certification	Germanischer Lloyd					

1) Note operating range of proximity sensors

2) Corrosion resistance class 2 as per Festo standard 940 070

Components subject to moderate corrosion stress. Externally visible parts with primarily decorative surface requirements which are in direct contact with a normal industrial environment or media such as coolants or lubricating agents.

Impact energy [J]						
Piston Ø	32	40	50	63	80	100
Max. impact energy at the end positions	0.1	0.2	0.2	0.5	0.9	1.2

Permissible impact velocity:

$$v_{perm.} = \sqrt{\frac{2 \times E_{perm.}}{m_{dead} + m_{load}}}$$

$v_{perm.}$ Permissible impact velocity

$E_{perm.}$ Max. impact energy

$m_{intrinsic}$ Moving load (drive)

m_{load} Moving effective load

 Note

This data represents the maximum values that can be achieved. The maximum permissible impact energy must be observed.

Maximum permissible load:

$$m_{load} = \frac{2 \times E_{perm.}}{v^2} - m_{dead}$$

Forces [N]						
Piston Ø	32	40	50	63	80	100
Theoretical force at 6 bar, advancing	483	754	1,178	1,870	3,016	4,712
Theoretical force at 6 bar, retracting	415	633	990	1,682	2,721	4,418
Static holding force	500		2,000		5,000	

Sizing example

 Note

When sizing pneumatic cylinders it is recommended as a basic principle that only 50% of the indicated theoretical forces (see above) be used.

Given:

Installation position = Vertical

Workpiece load = 44 kg

$$F = m \times g = 44 \text{ kg} \times 9.81 \text{ m/s}^2 = 431.6 \text{ N}$$

To be calculated:

Suitable piston Ø

Example with 32 mm piston Ø:

Theoretical force at 6 bar, advancing = 483 N

50% of the theoretical force = 241.5 N

Static holding force with 32 mm piston Ø = 500 N

The static holding force of end-position locking is within the permissible range (max. 500 N) with a workpiece load of 44 kg (431.6 N), however the cylinder would be at 89% capacity.

Result:

A cylinder with a piston Ø of 40 mm is therefore recommended for this application.

Standard cylinders DNC-EL, standard hole pattern, with end-position locking

Technical data

Max. lateral force F_q as a function of stroke length l

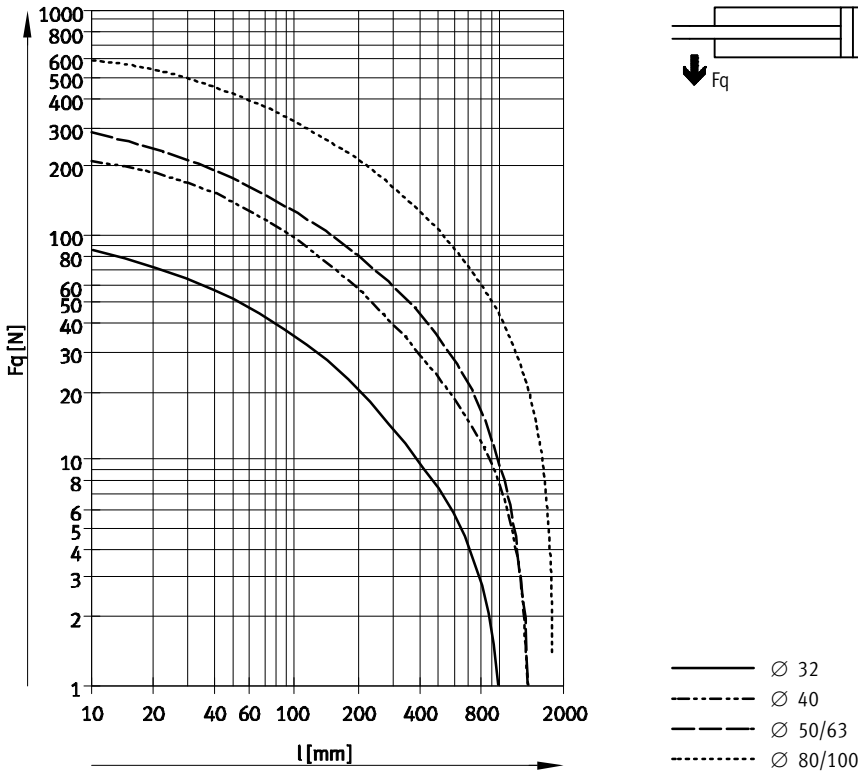

Weight [g]						
Piston Ø	32	40	50	63	80	100
Basic version						
Product weight with 0 mm stroke	537	820	1,320	1,769	2,970	4,833
Additional weight per 10 mm stroke	30	45	64	73	106	115
S2 – Through piston rod						
Product weight with 0 mm stroke	596	915	1,450	1,977	3,294	5,477
Additional weight per 10 mm stroke	39	61	89	98	144	153

Materials

Sectional view

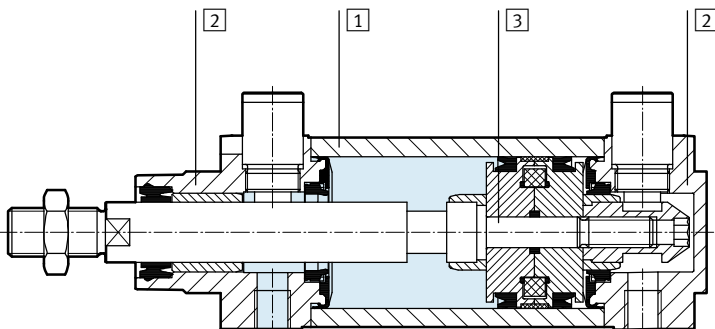

Standard cylinder	
1	Profile barrel Wrought aluminium alloy, smooth anodised
2	Bearing and end caps Die-cast aluminium
3	Piston rod High-alloy steel
-	Seals Polyurethane, nitrile rubber
Note on materials RoHS compliant	

Standard cylinders DNC-EL, standard hole pattern, with end-position locking

Technical data

Dimensions – Basic version

Download CAD data → www.festo.com

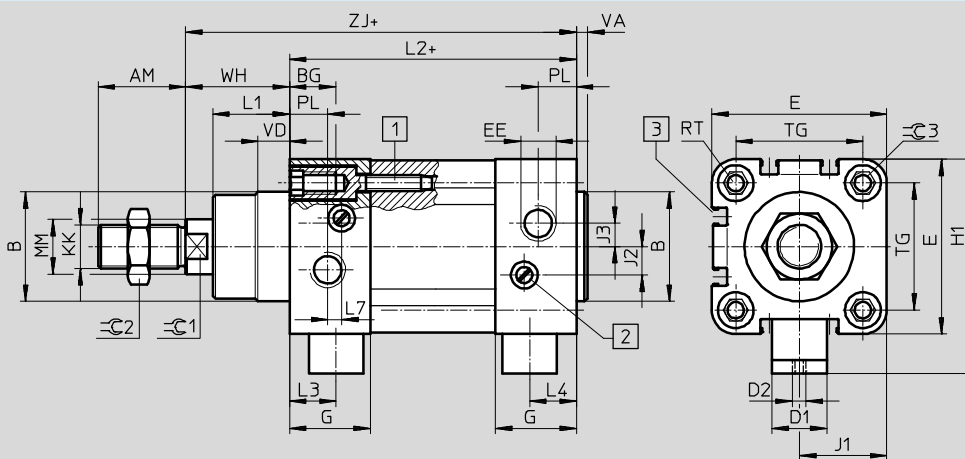

- 1 Socket head screw with female thread for mounting attachments
 - 2 Regulating screw for adjustable end-position cushioning
 - 3 Slot for proximity sensor
- + = plus stroke length

Dimensions – Variants

Download CAD data → www.festo.com

S2 – Through piston rod

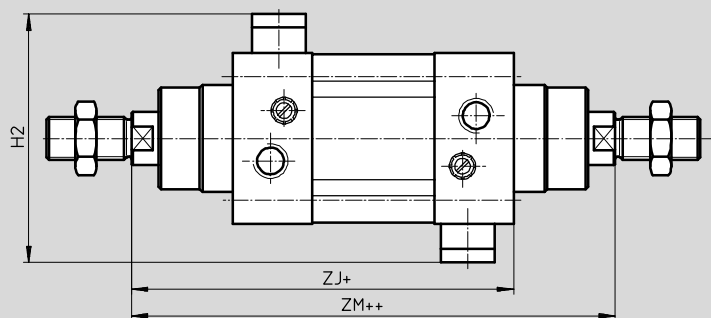

- + = plus stroke length
- ++ = plus 2x stroke length

∅	AM	B	BG	D1	D2	E	EE	G	H1	H2	J1	J2	J3	KK	L1
[mm]		∅ d11		∅ f8											
32	22	30	16	13	M3	45	G1/8	25.1	57.5	70	22.5	6	5.2	M10x1.25	18
40	24	35	16	13	M3	54	G1/4	29.6	64	74	27	8	6	M12x1.25	21.5
50	32	40	17	20	M5	64	G1/4	29.6	78.5	93	32	10.4	8.5	M16x1.5	28
63	32	45	17	20	M5	75	G3/8	35.6	84.5	93	37.5	12.4	10	M16x1.5	28.5
80	40	45	17	30	M5	93	G3/8	35.9	104.5	116	46.5	12.5	8	M20x1.5	34.7
100	40	55	17	30	M5	110	G1/2	38.8	113.5	116	55	12	10	M20x1.5	38.2

∅	L2	L3	L4	L7	MM	PL	RT	TG	VA	VD	WH	ZM	ZJ	C1	C2	C3
[mm]					∅						±2					
32	94	13.8	12	3.3	12	15.6	M6	32.5	4	10	26	148	120	10	16	6
40	105	16.6	16.6	3.6	16	14	M6	38	4	10.5	30	167	135	13	18	6
50	106	17.1	17.1	5.1	20	14	M8	46.5	4	11.5	37	183	143	17	24	8
63	121	16.6	16.6	6.6	20	17	M8	56.5	4	15	37	199	158	17	24	8
80	128	19.9	19.9	10.5	25	16.4	M10	72	4	15.7	46	222	174	22	30	6
100	138	22.8	22.8	8	25	18.8	M10	89	4	19.2	51	240	189	22	30	6

Note: This product conforms to ISO 1179-1 and to ISO 228-1

Standard cylinders DNC-EL, standard hole pattern, with end-position locking

Technical data

Dimensions – Variants

Download CAD data → www.festo.com

K2 – Extended male piston rod thread

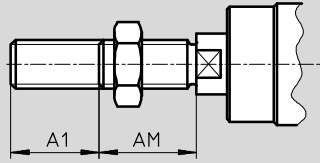

K3 – Female piston rod thread

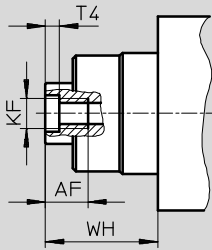

K5 – Special piston rod thread

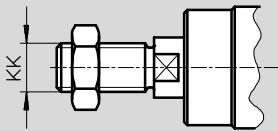

K8 – Extended piston rod

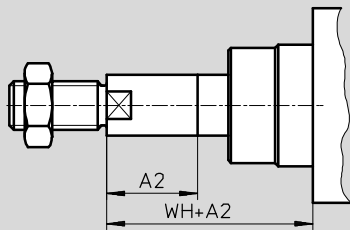

Note

In combination with variant S2, the piston rod is extended at one end.

∅ [mm]	A1 max.	A2 max.	AF	AM	KF	KK		T4	WH	⊙C1
						Basic thread	Special thread ¹⁾			
32	35	500	12	22	M6	M10x1.25	M10	2.6	26	10
40	35	500	12	24	M8	M12x1.25	M12	3.3	30	13
50	70	500	16	32	M10	M16x1.5	M16	4.7	37	17
63	70	500	16	32	M10	M16x1.5	M16	4.7	37	17
80	70	500	20	40	M12	M20x1.5	M20	6.1	46	22
100	70	500	20	40	M12	M20x1.5	M20	6.1	51	22

1) The special threads are only available as male threads. The mounting nut on the piston rod thread is included in the scope of delivery

Standard cylinders DNC-EL, standard hole pattern, with end-position locking

Ordering data – Modular products

M Mandatory data					O Options →	
Module No.	Function	Piston Ø	Stroke	Cushioning	Position sensing	Type of piston rod
163 302	DNC	32	10 ... 2,000	P	A	S2
163 334		40		PPV		
163 366		50				
163 398		63				
163 430		80				
163 462		100				
Order example						
163 430	DNC	- 80	- 550	- PPV	- A	- S2

Ordering table									
Size	32	40	50	63	80	100	Condi- tions	Code	Enter code
M Module No.	163 302	163 334	163 366	163 398	163 430	163 462			
Function	Standard cylinder, double-acting, standard hole pattern, with end-position locking							DNC	DNC
Piston Ø [mm]	32	40	50	63	80	100		-...	
Stroke [mm]	10 ... 2,000							-...	
Cushioning	Flexible cushioning rings/pads at both ends							-P	
	Pneumatic cushioning, adjustable at both ends							-PPV	
O Position sensing	Via proximity sensor							-A	
↓ Type of piston rod	Through piston rod						1	-S2	

- 1 S2** In combination with K2: extended thread at both ends
In combination with K3: female thread at both ends
In combination with K5: special thread at both ends

Transfer order code

Standard cylinders DNC-EL, standard hole pattern, with end-position locking

Ordering data – Modular products

→ Options M

Extended male thread	Female thread	Special thread	Extended piston rod	End-position locking
...K2	K3	...K5	...K8	ELB ELV ELH
	K3		100K8	

Ordering table										
Size	32	40	50	63	80	100	Condi- tions	Code	Enter code	
↓										
0 Extended male thread [mm]	Piston rod with extended male thread							2	-...K2	
Female thread	Piston rod with female thread							3	-K3	
Special thread	Piston rod with special thread								-...K5	
Extended piston rod [mm]	Extended piston rod								-...K8	
M End-position locking	At both ends						4	-ELB		
	At front						4	-ELV		
	At rear						4	-ELH		

- K2** Not with K3
- K3** With K5: on request
- ELB, ELV, ELH**
In combination with K8 and S2: on request only

Transfer order code

- - - - -

Standard cylinders DNC-V1 ... V6, standard hole pattern, cyl./valve combination

Technical data

Function

DNC-...

Without position sensing

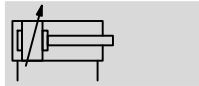
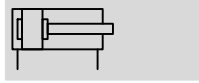

DNC-...-A-...

With position sensing

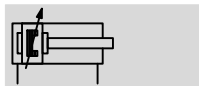
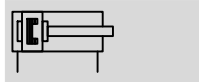

-  - Diameter
32 ... 100 mm

-  - Stroke length
100 ... 2,000 mm

-  - www.festo.com

Wearing parts kits
→ 32

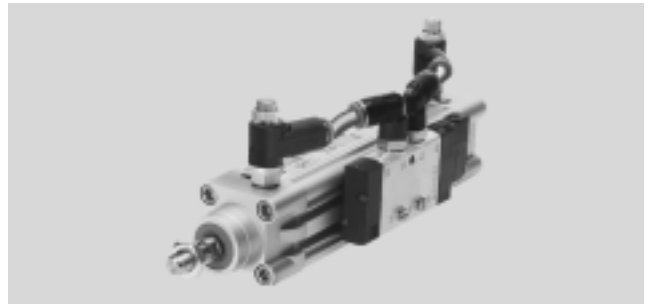

Valve variants

Single solenoid valve unactuated, piston rod retracted

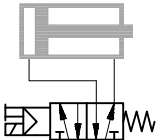

DNC-...-V1

fitted on right

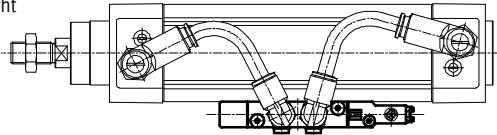

DNC-...-V4

fitted on left

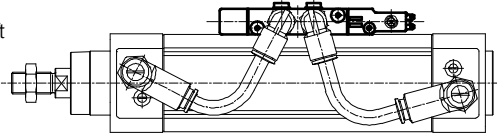

Double solenoid valve unactuated, piston rod retracted

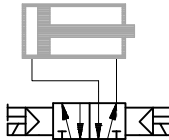

DNC-...-V3

fitted on right

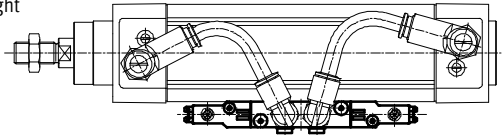

DNC-...-V6

fitted on left

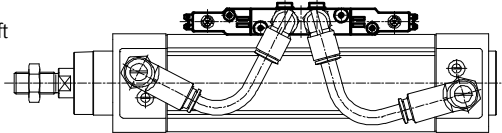

Single solenoid valve unactuated, piston rod advanced

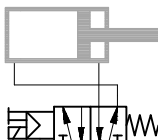

DNC-...-V2

fitted on right

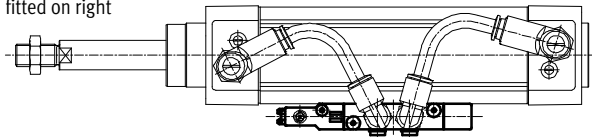

DNC-...-V5

fitted on left

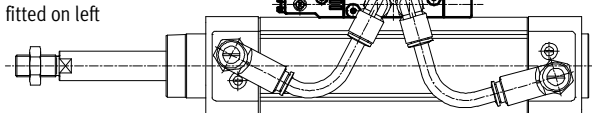

-  - Note
As viewed from the front of the cylinder (piston rod end) with valve fitted on left or right.

In this example, the valve is fitted on the right.

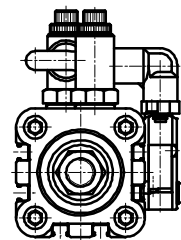

Standard cylinders DNC-V1 ... V6, standard hole pattern, cyl./valve combination

Technical data

General technical data							
Piston Ø		32	40	50	63	80	100
Cylinder							
Pneumatic connection		G1/8	G1/4	G1/4	G3/8	G3/8	G1/2
Piston rod thread		M10x1.25	M12x1.25	M16x1.5	M16x1.5	M20x1.5	M20x1.5
	K3	M6	M8	M10	M10	M12	M12
	K5	M10	M12	M16	M16	M20	M20
Constructional design		Piston					
		Piston rod					
		Profile barrel					
Cushioning		Flexible cushioning rings/pads at both ends					
		Pneumatic cushioning, adjustable at both ends					
Cushioning length PPV	[mm]	20	20	22	22	32	32
Position sensing		Via proximity sensor					
Type of mounting		Via female thread					
		Via accessories					
Mounting position		Any					
Valve Ordering data – Valves and accessories → 48							
Valve used	single solenoid	CPE14-M1BH-5L-1/8		CPE18-M1H-5L-1/4		CPE24-M1H-5L-3/8	
	double solenoid	CPE14-M1BH-5J-1/8		CPE18-M1H-5J-1/4		CPE24-M1H-5J-3/8	
Pneumatic connection		G1/8		G1/4		G3/8	
Constructional design		Piston spool valve					
Type of mounting		Via mounting kit					
Operating voltage	[V DC]	24 +10/-15%					
Power consumption	[W]	1		1.5			
Duty cycle		100%					
Protection class with plug socket		IP65					

• † - Note: This product conforms to ISO 1179-1 and to ISO 228-1

Operating and environmental conditions							
Piston Ø		32	40	50	63	80	100
Operating medium		Compressed air in accordance with ISO 8573-1:2010 [7:4:4]					
Note on operating/pilot medium		Operation with lubricated medium possible (in which case lubricated operation will always be required)					
Operating pressure	[bar]	3 ... 8		2.5 ... 10			
Ambient temperature ¹⁾	[°C]	0 ... +50					
Corrosion resistance class CRC ²⁾		2					
Certification		Germanischer Lloyd					

1) Note operating range of proximity sensors

2) Corrosion resistance class 2 as per Festo standard 940 070

Components subject to moderate corrosion stress. Externally visible parts with primarily decorative surface requirements which are in direct contact with a normal industrial environment or media such as coolants or lubricating agents.

Standard cylinders DNC-V1 ... V6, standard hole pattern, cyl./valve combination

Technical data

Force [N] and impact energy [J]							
Piston Ø	32	40	50	63	80	100	
Theoretical force at 6 bar, advancing		483	754	1,178	1,870	3,016	4,712
	S2/S20	415	633	990	1,682	2,721	4,418
Theoretical force at 6 bar, retracting		415	633	990	1,682	2,721	4,418
	S2/S20	415	633	990	1,682	2,721	4,418
Max. impact energy at the end positions ¹⁾	0.1	0.2	0.2	0.5	0.9	1.2	

1) The permissible impact energy is reduced by approx. 10% for variants K10 and S20

Permissible impact velocity:

$$v_{perm.} = \sqrt{\frac{2 \times E_{perm.}}{m_{dead} + m_{load}}}$$

$v_{perm.}$ Permissible impact velocity

$E_{perm.}$ Max. impact energy

$m_{intrinsic}$ Moving load (drive)

m_{load} Moving effective load

 Note
This data represents the maximum values that can be achieved. The maximum permissible impact energy must be observed.

Maximum permissible load:

$$m_{load} = \frac{2 \times E_{perm.}}{v^2} - m_{dead}$$

Max. lateral force F_q as a function of stroke length l

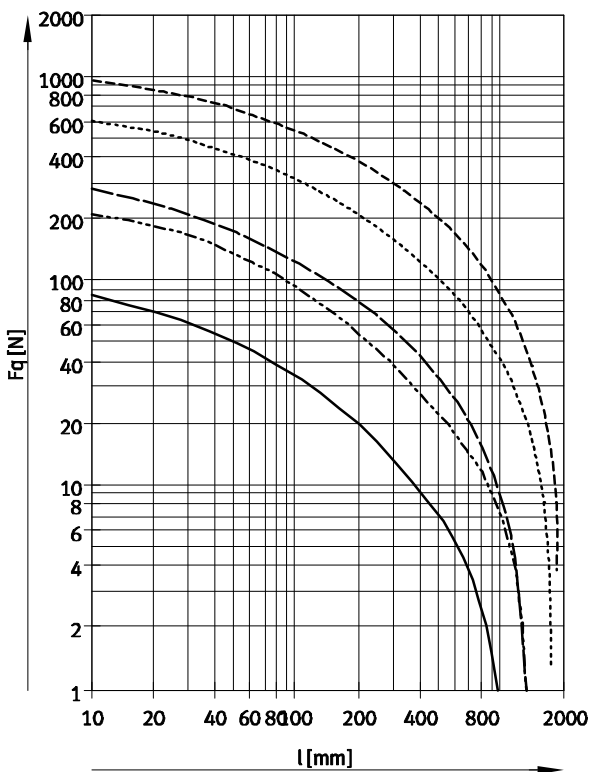

Standard cylinders DNC-V1 ... V6, standard hole pattern, cyl./valve combination

Technical data

Materials

Sectional view

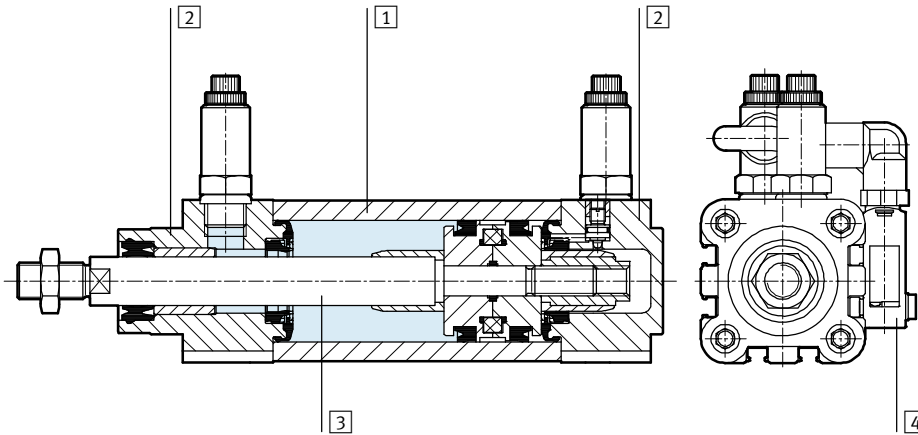

Standard cylinder	Basic version	R8	S10	S11	K10
1 Profile barrel	Wrought aluminium alloy, smooth anodised				
2 Bearing and end caps	Die-cast aluminium				
3 Piston rod	High-alloy steel	Tempered steel	High-alloy steel		Wrought aluminium alloy, anodised
- Seals, cylinder	Polyurethane, nitrile rubber		Fluoro rubber		Polyurethane, nitrile rubber
4 Housing, valve	Die-cast aluminium, polyamide, steel				
- Seals, valve	Nitrile rubber				
Note on materials	RoHS compliant				

Standard cylinders DNC-V1 ... V6, standard hole pattern, cyl./valve combination

Technical data

Dimensions

Download CAD data → www.festo.com

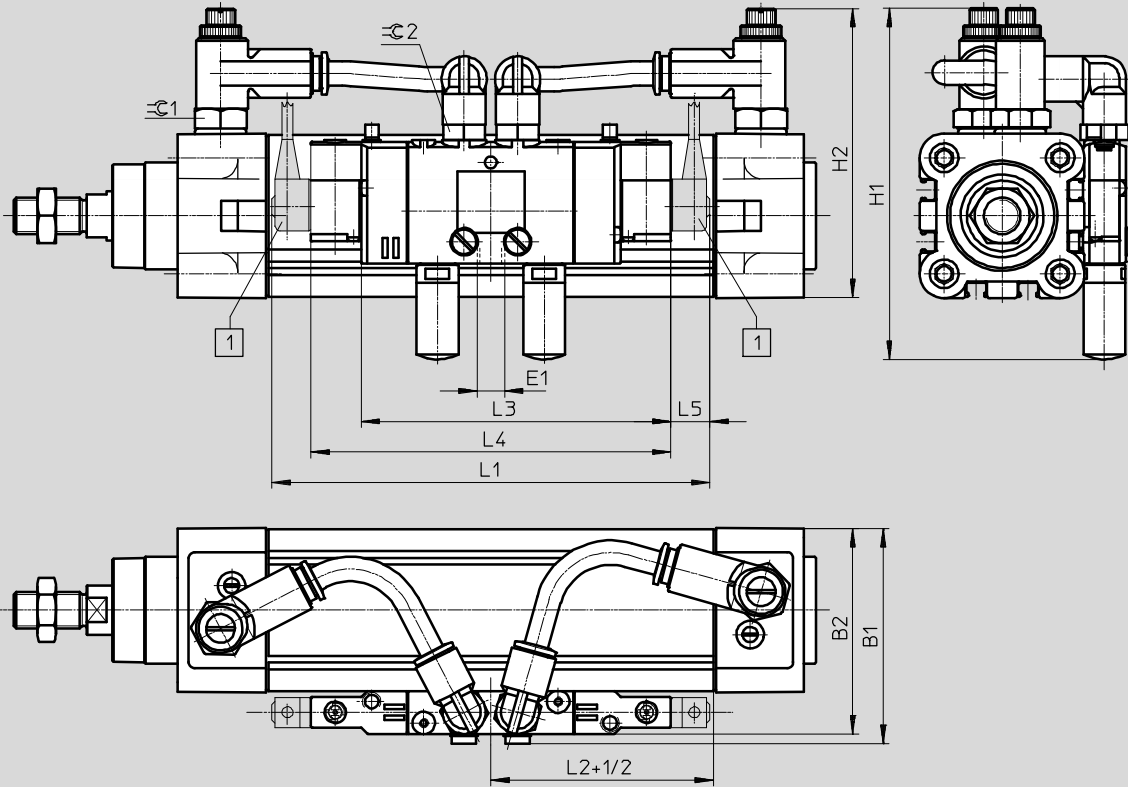

1 Plug socket not included in scope of delivery

+1/2 = plus half stroke length

Standard cylinders DNC-V1 ... V6, standard hole pattern, cyl./valve combination

Technical data

∅ [mm]	B1	B2	E1	H1	H2	L1 max.	L2 ±3	L3	L4	L5	⌀C1	⌀C2
32	62	59	G1/8	109 ^{+5.5}	86 ^{+5.5}	152	22	102	118	13	13	14
40	71	68	G1/8	114 ^{+5.5}	94 ^{+5.5}	152	23	102	118	13	17	14
50	85	82	G1/4	131 ^{+5.5}	104 ^{+5.5}	215	24	138	163	25	17	14
63	96	93	G1/4	142 ^{+5.5}	115 ^{+5.5}	215	25	138	163	25	19	14
80	123	119	G3/8	194 ^{+5.5}	133 ^{+5.5}	242	28	165	165	25	19	17
100	140	136	G3/8	213 ⁺²	158 ⁺²	242	30	165	165	25	27	17

· || · Note: This product conforms to ISO 1179-1 and to ISO 228-1

 - Note
 Additional dimensions relating to the basic version and its variants are provided on page → 15, with clamping unit on page → 28.

Standard cylinders DNC-V1 ... V6, standard hole pattern, cyl./valve combination

Ordering data – Modular products

M Mandatory data					O Options →		
Module No.	Function	Piston Ø	Stroke	Cushioning	Position sensing	Protection against rotation	Type of piston rod
163 302	DNC	32	100 ... 2,000	P PPV	A	Q	S2 S20
163 334		40					
163 366		50					
163 398		63					
163 430		80					
163 462		100					
Order example							
163 430	DNC	- 80	- 550	- PPV	- A	- Q	- S2

Ordering table											
Size	32	40	50	63	80	100	Condi- tions	Code	Enter code		
M Module No.	163 302	163 334	163 366	163 398	163 430	163 462					
Function	Standard cylinder, double-acting, standard hole pattern, cylinder/valve combination								DNC	DNC	
Piston Ø [mm]	32	40	50	63	80	100		-...			
Stroke [mm]	100 ... 2,000								-...		
Cushioning	Flexible cushioning rings/pads at both ends								-P		
	Pneumatic cushioning, adjustable at both ends								-PPV		
O Position sensing	Via proximity sensor								-A		
Protection against rotation	Square piston rod							1	-Q		
Type of piston rod	Through piston rod							2	-S2		
	Through, hollow piston rod							3	-S20		

1 Q Max. stroke: 100 ... 1,500 mm
 In combination with S2: square piston rod at bearing cap end only
 In combination with KP: only supplied with S2
 Not with S20, K7, K10, S10, S11

2 S2 In combination with K2: extended thread at both ends
 In combination with K3: female thread at both ends
 In combination with K5: special thread at both ends
 In combination with K8: piston rod extended at bearing cap end only
 In combination with KP: clamping unit at end cap
 Not with S20, K7, S10, S11

3 S20 Max. stroke: 850 mm
 In combination with K8: piston rod extended end only
 Not with K2, K3, K5, K10, KP, S10, S11

Transfer order code

DNC - - - - - -

Standard cylinders DNC-V1 ... V6, standard hole pattern, cyl./valve combination

Ordering data – Modular products

Options									M
Extended male thread	Female thread	Special thread	Special spanner flats	Extended piston rod	Improved running performance	Clamping unit	Slow speed (constant motion)	Running characteristics	Cylinder/valve combination
...K2	K3	...K5	K7	...K8	K10	KP	S10	S11	V1 V2 V3 V4 V5 V6
-	-	-	-	100K8	-	-	-	-	V2

Ordering table											
Size	32	40	50	63	80	100	Condi- tions	Code	Enter code		
Extended male thread [mm]	Piston rod with extended male thread		1 ... 35				1 ... 70		4	-...K2	
Female thread	Piston rod with female thread		(M6)	(M8)	(M10)	(M10)	(M12)	(M12)	5	-K3	
Special thread	Piston rod with special thread		M10	M12	M16	M16	M20	M20	6	-...K5	
Special spanner flats	Piston rod with external hexagon							7	-K7		
Extended piston rod [mm]	Extended piston rod		1 ... 500							-...K8	
Improved running performance	Smooth anodised aluminium coated piston rod							8	-K10		
Clamping unit	Attached							9	-KP		
Slow speed (constant motion)	Slow speed (constant motion at low piston speeds)							10	-S10		
Running characteristics	Low friction							11	-S11		
Cylinder/valve combination	Single solenoid valve, fitted on right, piston rod retracted when unactuated								-V1		
	Single solenoid valve, fitted on right, piston rod advanced when unactuated								-V2		
	Double solenoid valve, fitted on right								-V3		
	Single solenoid valve, fitted on left, piston rod retracted when unactuated								-V4		
	Single solenoid valve, fitted on left, piston rod advanced when unactuated								-V5		
	Double solenoid valve, fitted on left								-V6		

- 4 **K2** Not with K3, K10
- 5 **K3** With K5: on request
Not with K7
- 6 **K5** Not with K10
- 7 **K7** Not with Q, S2, K10

- 8 **K10** Max. stroke: 1,000 mm
Not with KP
- 9 **KP** Without S2: position of the clamping unit at the bearing cap
Not with S10, S11
- 10 **S10** Max. stroke: 500 mm; additional strokes on request
Not with S11
- 11 **S11** Max. stroke: 500 mm; additional strokes on request

Transfer order code

- [] - [] - [] - [] - [] - [] - [] - [] - [] - []

Standard cylinders DNC-V1 ... V6, standard hole pattern, cyl./valve combination

Accessories

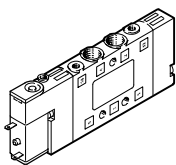
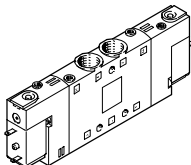
Ordering data – Valves		Technical data → Internet: cpe			
	For Ø [mm]	Pneumatic connection	Protection class	Part No.	Type
Single solenoid					
	32	G1/8	IP65	196 941	CPE14-M1BH-5L-1/8
	40				
	50	G1/4	IP65	163 142	CPE18-M1H-5L-1/4
	63				
	80	G3/8	IP65	163 166	CPE24-M1H-5L-3/8
100					
Double solenoid					
	32	G1/8	IP65	196 939	CPE14-M1BH-5J-1/8
	40				
	50	G1/4	IP65	163 143	CPE18-M1H-5J-1/4
	63				
	80	G3/8	IP65	163 167	CPE24-M1H-5J-3/8
100					

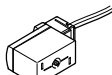
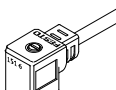
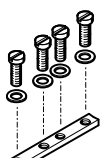
Ordering data – Valve accessories		Technical data → Internet: quick star			
	For valve	Part No.	Type	PU ¹⁾	
Push-in fitting QS					
	CPE14	153 015	QS-1/8-8-I	10	
	CPE18	153 018	QS-1/4-10-I	10	
	CPE24	153 020	QS-3/8-12-I	10	
Plug socket KMYZ/KMEB					
	CPE14	24 V DC, with PUR cable 2.5 m	193 687	KMYZ-9-24-2,5-LED-PUR-B	1
		24 V DC, with PUR cable 5 m	193 689	KMYZ-9-24-5-LED-PUR-B	
	CPE18	24 V DC, with PVC cable 2.5 m, LED	151 688	KMEB-1-24-2,5-LED	1
	CPE24	24 V DC, with PVC cable 5 m, LED	151 689	KMEB-1-24-5-LED	
		24 V DC, with PVC cable 10 m, LED	193 457	KMEB-1-24-10-LED	
Mounting kit ZVB					
	CPE14	185 705	ZVB-8-14/18	-	
	CPE18				
	CPE24	187 388	ZVB-8-24	-	

1) Packaging unit quantity

Standard cylinders DNC, ISO 15552

Accessories

Multi-position kit DPNC

Material:

Flange: Wrought aluminium alloy

Threaded studs, hex nuts:

Galvanised steel

Free of copper and PTFE

RoHS-compliant

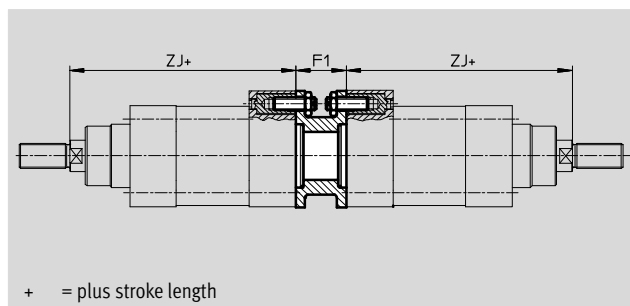
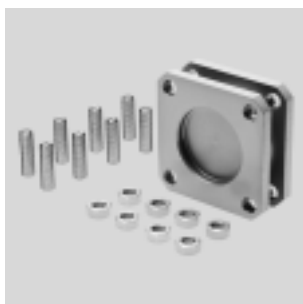

Dimensions and ordering data

For Ø [mm]	F1	ZJ		Max. overall stroke length [mm]	Weight [g]	Part No.	Type
		Basic version	KP				
32	27	120	165	1,000	85	174418	DPNC-32
40	27	135	188	1,000	115	174419	DPNC-40
50	32	143	210	1,000	210	174420	DPNC-50
63	28	158	234	1,000	360	174421	DPNC-63
80	38	174	269	1,000	620	174422	DPNC-80
100	38	189	287	1,000	1,190	174423	DPNC-100
125	48	225	350	1,000	1,600	174424	DPNC-125

 Note
The maximum overall stroke length must not be exceeded when combining cylinders and multi-position kits.

Connecting two cylinders with identical piston diameter as a 3 or 4-position cylinder

A 3 or 4-position cylinder consists of two separate cylinders whose piston rods advance in opposing directions.

This means that depending on actuation and stroke division, this type of cylinder can assume up to four

positions. In each case the cylinder is driven precisely against a stop. Note that when one end of the piston rod is

fixed, the cylinder barrel executes the movement. The cylinder's connections must be flexible.

To achieve 3 positions

Two cylinders with identical stroke length must be connected together.

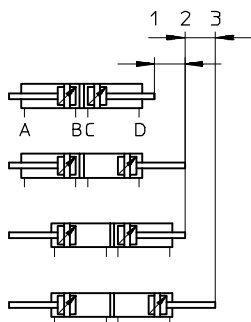

To achieve 4 positions

Two cylinders with different stroke lengths must be connected together.

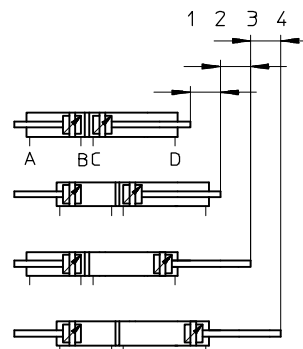

Standard cylinders DNC, ISO 15552

Accessories

Foot mounting HNC/CRHNC

Material:

HNC: Galvanised steel

CRHNC: High-alloy steel

Free of copper and PTFE

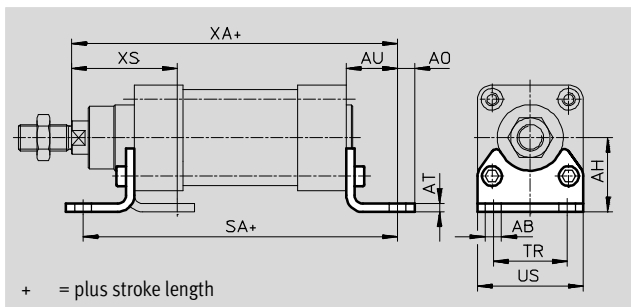

Dimensions and ordering data												
For Ø [mm]	AB Ø	AH	AO	AT	AU	SA		TR	US	XA		XS
						Basic version	KP			Basic version	KP	
32	7	32	6.5	4	24	142	187	32	45	144	189	45
40	10	36	9	4	28	161	214	36	54	163	216	53
50	10	45	9.5	5	32	170	237	45	64	175	242	62
63	10	50	12.5	5	32	185	261	50	75	190	266	63
80	12	63	15	6	41	210	305	63	93	215	310	81
100	14.5	71	17.5	6	41	220	318	75	110	230	328	86
125	16.5	90	22	8	45	250	375	90	131	270	395	102

For Ø [mm]	Basic version				High corrosion protection			
	CRC ¹⁾	Weight [g]	Part No.	Type	CRC ¹⁾	Weight [g]	Part No.	Type
32	2	144	174369	HNC-32	4	139	176937	CRHNC-32
40	2	193	174370	HNC-40	4	188	176938	CRHNC-40
50	2	353	174371	HNC-50	4	341	176939	CRHNC-50
63	2	436	174372	HNC-63	4	424	176940	CRHNC-63
80	2	829	174373	HNC-80	4	809	176941	CRHNC-80
100	2	1,009	174374	HNC-100	4	990	176942	CRHNC-100
125	2	1,902	174375	HNC-125	4	1,920	176943	CRHNC-125

1) Corrosion resistance class 2 as per Festo standard 940 070
 Components subject to moderate corrosion stress. Externally visible parts with primarily decorative surface requirements which are in direct contact with a normal industrial environment or media such as coolants or lubricating agents.
 Corrosion resistance class 4 as per Festo standard 940 070
 Components requiring higher corrosion resistance. Parts used with aggressive media, e.g. food or chemical industry. These applications should be supported with special tests with the media if required.

Standard cylinders DNC, ISO 15552

Accessories

Flange mounting FNC/CRFNG

Material:

FNC: Galvanised steel

CRFNG: High-alloy steel

Free of copper and PTFE

RoHS-compliant

Cannot be used on the bearing cap in combination with the bellows kit

DADB

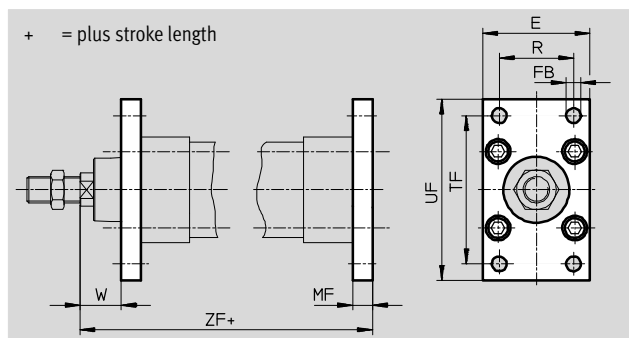

Dimensions and ordering data									
For \varnothing	E	FB	MF	R	TF	UF	W	ZF	
[mm]		\varnothing H13						Basic version	KP
32	45	7	10	32	64	80	16	130	175
40	54	9	10	36	72	90	20	145	198
50	65	9	12	45	90	110	25	155	222
63	75	9	12	50	100	120	25	170	246
80	93	12	16	63	126	150	30	190	285
100	110	14	16	75	150	175	35	205	303
125	132	16	20	90	180	210	45	245	370

For \varnothing	Basic version				High corrosion protection			
	CRC ¹⁾	Weight [g]	Part No.	Type	CRC ¹⁾	Weight [g]	Part No.	Type
[mm]								
32	1	221	174376	FNC-32	4	225	161846	CRFNG-32
40	1	291	174377	FNC-40	4	300	161847	CRFNG-40
50	1	536	174378	FNC-50	4	540	161848	CRFNG-50
63	1	679	174379	FNC-63	4	680	161849	CRFNG-63
80	1	1,495	174380	FNC-80	4	1,500	161850	CRFNG-80
100	1	2,041	174381	FNC-100	4	2,100	161851	CRFNG-100
125	1	3,775	174382	FNC-125	4	3,780	185363	CRFNG-125

1) Corrosion resistance class 1 as per Festo standard 940 070
 Components with light corrosion exposure. Protection for transport and storage. Components without significant decorative function or surface, e.g. installed out of sight internally or behind covers.
 Corrosion resistance class 4 as per Festo standard 940 070
 Components requiring higher corrosion resistance. Parts used with aggressive media, e.g. food or chemical industry. These applications should be supported with special tests with the media if required.

Standard cylinders DNC, ISO 15552

Accessories

Trunnion flange ZNCF/CRZNG

Material:

ZNCF: Special steel casting
 CRZNG: Electrolytically polished special steel casting

Free of copper and PTFE

RoHS-compliant

Cannot be used on the bearing cap in combination with the bellows kit

DADB

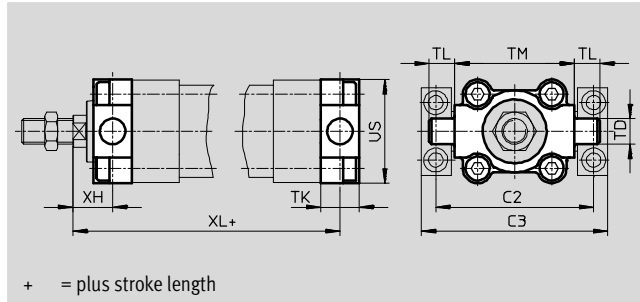

+ = plus stroke length

Dimensions and ordering data										
For Ø [mm]	C2	C3	TD Ø e9	TK	TL	TM	US	XH	XL	
									Basic version	KP
32	71	86	12	16	12	50	45	18	128	173
40	87	105	16	20	16	63	54	20	145	198
50	99	117	16	24	16	75	64	25	155	222
63	116	136	20	24	20	90	75	25	170	246
80	136	156	20	28	20	110	93	32	188	283
100	164	189	25	38	25	132	110	32	208	306
125	192	217	25	50	25	160	131	40	250	375

For Ø [mm]	Basic version				High corrosion protection			
	CRC ¹⁾	Weight [g]	Part No.	Type	CRC ¹⁾	Weight [g]	Part No.	Type
32	2	150	174411	ZNCF-32	4	150	161852	CRZNG-32
40	2	285	174412	ZNCF-40	4	285	161853	CRZNG-40
50	2	473	174413	ZNCF-50	4	473	161854	CRZNG-50
63	2	687	174414	ZNCF-63	4	687	161855	CRZNG-63
80	2	1,296	174415	ZNCF-80	4	1,296	161856	CRZNG-80
100	2	2,254	174416	ZNCF-100	4	2,254	161857	CRZNG-100
125	2	3,484	174417	ZNCF-125	4	3,484	185362	CRZNG-125

1) Corrosion resistance class 2 as per Festo standard 940 070
 Components subject to moderate corrosion stress. Externally visible parts with primarily decorative surface requirements which are in direct contact with a normal industrial environment or media such as coolants or lubricating agents.
 Corrosion resistance class 4 as per Festo standard 940 070
 Components requiring higher corrosion resistance. Parts used with aggressive media, e.g. food or chemical industry. These applications should be supported with special tests with the media if required.

Standard cylinders DNC, ISO 15552

Accessories

Trunnion mounting kit DAMT for basic version DNC

The mounting kit can be attached at any position along the profile barrel of a cylinder.

Material:
Tempered steel
Free of copper and PTFE

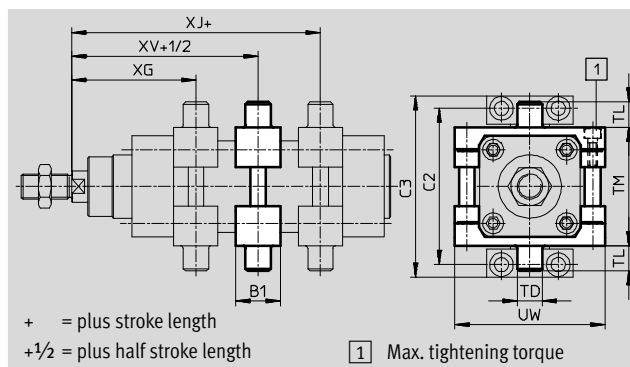

for DNC-KP

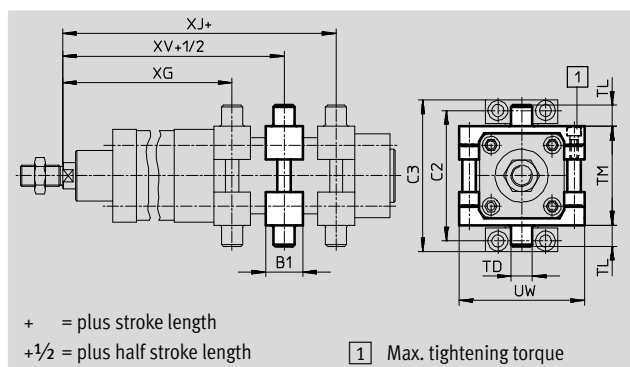

Dimensions and ordering data									
For Ø	B1	C2	C3	TD Ø e9	TL	TM	UW	XG	
								Basic version	KP
32	30	71	86	12	12	50	65	66.1	111.1
40	32	87	105	16	16	63	75	75.6	128.6
50	34	99	117	16	16	75	95	83.6	150.6
63	41	116	136	20	20	90	105	93.1	169.1
80	44	136	156	20	20	110	130	103.9	198.9
100	48	164	189	25	25	132	145	113.8	211.8
125	50	192	217	25	25	160	175	134.7	259.7

For Ø	XJ		XV		Max. tightening torque [Nm]	CRC ¹⁾	Weight [g]	Part No.	Type
		KP		KP					
32	79.9	124.9	73	118	4+1	2	213	2213233	DAMT-V1-32-A
40	89.4	142.4	82.5	135.5	8+1	2	388	2214899	DAMT-V1-40-A
50	96.4	163.4	90	157	8+2	2	608	2214909	DAMT-V1-50-A
63	101.9	177.9	97.5	173.5	18+2	2	911	2214971	DAMT-V1-63-A
80	116.1	211.1	110	205	28+2	2	1,494	163529	DAMT-V1-80-A
100	126.2	224.2	120	218	28+2	2	2,095	163530	DAMT-V1-100-A
125	155.3	280.3	145	270	40+2	2	3,013	163531	DAMT-V7-125-A

1) Corrosion resistance class 2 as per Festo standard 940 070
Components subject to moderate corrosion stress. Externally visible parts with primarily decorative surface requirements which are in direct contact with a normal industrial environment or media such as coolants or lubricating agents.

Standard cylinders DNC, ISO 15552

Accessories

Trunnion support LNZG

Material:
 Trunnion support:
 Anodised aluminium
 Plain bearing: Polymer
 Free of copper and PTFE
 RoHS-compliant

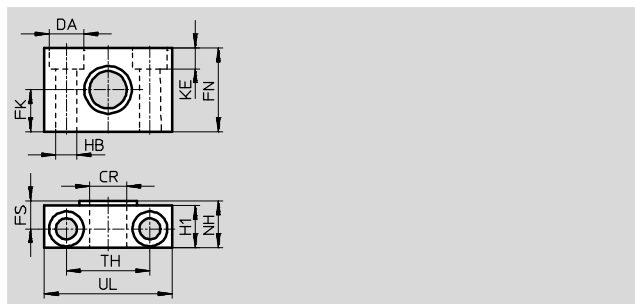

Dimensions and ordering data															
For \varnothing	CR	DA	FK	FN	FS	H1	HB	KE	NH	TH	UL	CRC ¹⁾	Weight	Part No.	Type
[mm]	\varnothing	\varnothing	\varnothing				\varnothing			± 0.2			[g]		
32	12	11	15	30	10.5	15	6.6	6.8	18	32	46	2	83	32959	LNZG-32
40, 50	16	15	18	36	12	18	9	9	21	36	55	2	129	32960	LNZG-40/50
63, 80	20	18	20	40	13	20	11	11	23	42	65	2	178	32961	LNZG-63/80
100, 125	25	20	25	50	16	24.5	14	13	28.5	50	75	2	306	32962	LNZG-100/125

1) Corrosion resistance class 2 as per Festo standard 940 070
 Components subject to moderate corrosion stress. Externally visible parts with primarily decorative surface requirements which are in direct contact with a normal industrial environment or media such as coolants or lubricating agents.

Trunnion support CRLNZG

Material:
 High-alloy steel
 Free of copper and PTFE
 RoHS-compliant

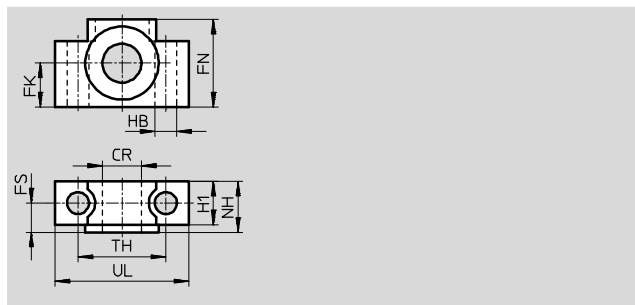
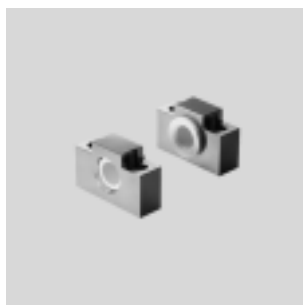

Dimensions and ordering data															
For \varnothing	CR	FK	FN	FS	H1	HB	NH	TH	UL	CRC ¹⁾	Weight	Part No.	Type		
[mm]	\varnothing	\varnothing				\varnothing		± 0.2			[g]				
32	12	15	30	10.5	15	6.6	18	32	46	4	205	161874	CRLNZG-32		
40, 50	16	18	36	12	18	9	21	36	55	4	323	161875	CRLNZG-40/50		
63, 80	20	20	40	13	20	11	23	42	65	4	435	161876	CRLNZG-63/80		
100, 125	25	25	50	16	24.5	14	28.5	50	75	4	739	161877	CRLNZG-100		

1) Corrosion resistance class 4 as per Festo standard 940 070
 Components requiring higher corrosion resistance. Parts used with aggressive media, e.g. food or chemical industry. These applications should be supported with special tests with the media if required.

Standard cylinders DNC, ISO 15552

Accessories

Swivel flange SNC

Material:
Die-cast aluminium
Free of copper and PTFE
RoHS-compliant

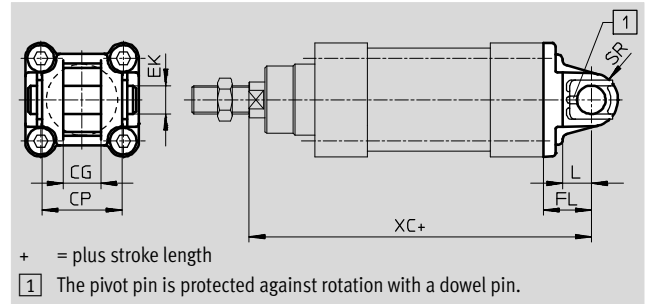

Dimensions and ordering data												
For Ø	CG	CP	EK Ø	FL ±0.2	L	SR	XC		CRC ¹⁾	Weight	Part No.	Type
[mm]	H14	h14	H9					KP		[g]		
32	14	34	10	22	13	10	142	187	2	90	174383	SNC-32
40	16	40	12	25	16	12	160	213	2	120	174384	SNC-40
50	21	45	16	27	16	12	170	237	2	240	174385	SNC-50
63	21	51	16	32	21	16	190	266	2	320	174386	SNC-63
80	25	65	20	36	22	16	210	305	2	625	174387	SNC-80
100	25	75	20	41	27	20	230	328	2	830	174388	SNC-100
125	37	97	30	50	30	25	275	400	2	1,785	174389	SNC-125

1) Corrosion resistance class 2 as per Festo standard 940 070
Components subject to moderate corrosion stress. Externally visible parts with primarily decorative surface requirements which are in direct contact with a normal industrial environment or media such as coolants or lubricating agents.

Standard cylinders DNC, ISO 15552

Accessories

Swivel flange SNCB/SNCB-...-R3

Material:
 SNCB: Die-cast aluminium
 SNCB-...-R3: Die-cast aluminium with protective coating, high corrosion protection
 Free of copper and PTFE
 RoHS-compliant

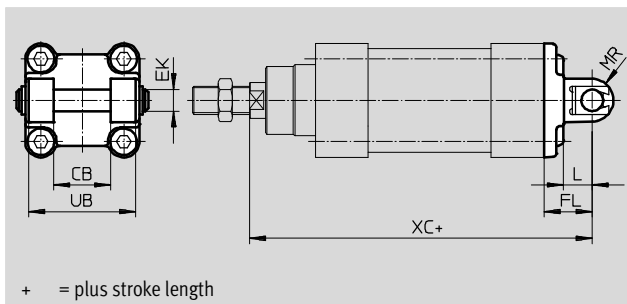

Dimensions and ordering data								
For \varnothing	CB	EK	FL	L	MR	UB	XC	
[mm]	H14	\varnothing e8	± 0.2			h14		KP
32	26	10	22	13	8.5	45	142	187
40	28	12	25	16	12	52	160	213
50	32	12	27	16	12	60	170	237
63	40	16	32	21	16	70	190	266
80	50	16	36	22	16	90	210	305
100	60	20	41	27	20	110	230	328
125	70	25	50	30	25	130	275	400

For \varnothing	Basic version				Variant R3 – High corrosion protection			
	CRC ¹⁾	Weight [g]	Part No.	Type	CRC ¹⁾	Weight [g]	Part No.	Type
[mm]								
32	2	103	174390	SNCB-32	3	100	176944	SNCB-32-R3
40	2	155	174391	SNCB-40	3	151	176945	SNCB-40-R3
50	2	232	174392	SNCB-50	3	228	176946	SNCB-50-R3
63	2	375	174393	SNCB-63	3	371	176947	SNCB-63-R3
80	2	636	174394	SNCB-80	3	632	176948	SNCB-80-R3
100	2	1,035	174395	SNCB-100	3	986	176949	SNCB-100-R3
125	2	1,860	174396	SNCB-125	3	1,776	176950	SNCB-125-R3

1) Corrosion resistance class 2 as per Festo standard 940 070
 Components subject to moderate corrosion stress. Externally visible parts with primarily decorative surface requirements which are in direct contact with a normal industrial environment or media such as coolants or lubricating agents.
 Corrosion resistance class 3 as per Festo standard 940 070
 Components requiring higher corrosion resistance. External visible parts in direct contact with industrial atmospheres or media such as solvents and cleaning agents, with a predominantly functional requirement for the surface.

Standard cylinders DNC, ISO 15552

Accessories

Swivel flange SNCS

Material:

SNCS 32 ... 80:

Die-cast aluminium

SNCS 100 ... 125:

Wrought aluminium alloy

Free of copper and PTFE

RoHS-compliant

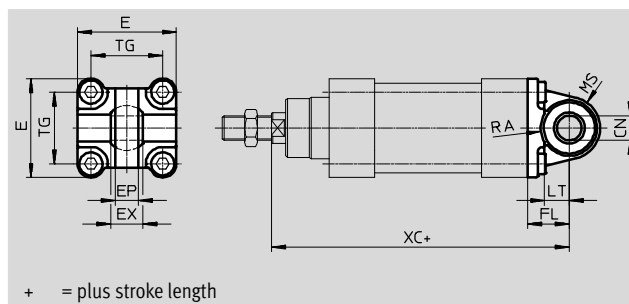
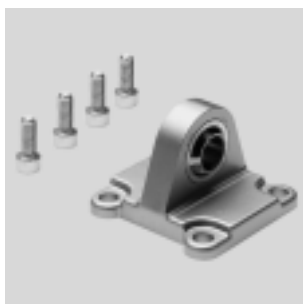

+ = plus stroke length

Dimensions and ordering data															
For \varnothing	CN	E	EP	EX	FL	LT	MS	RA	TG	XC		CRC ¹⁾	Weight	Part No.	Type
[mm]	\varnothing		± 0.2		± 0.2			+1			KP		[g]		
32	10 ^{+0.013}	45 ^{+0.2/-0.5}	10.5	14	22	13	15 ^{+0.5}	14.5	32.5	142	187	2	86	174397	SNCS-32
40	12 ^{+0.015}	54 ^{-0.5}	12	16	25	16	17 ^{+0.5}	17.5	38	160	213	2	122	174398	SNCS-40
50	16 ^{+0.015}	64 ^{-0.6}	15	21	27	16	20 ^{+0.5}	18.5	46.5	170	237	2	216	174399	SNCS-50
63	16 ^{+0.015}	75 ^{-0.6}	15	21	32	21	23 ^{-0.5}	23	56.5	190	266	2	281	174400	SNCS-63
80	20 ^{+0.018}	93 ^{-0.8}	18	25	36	22	28 ^{-0.5}	25	72	210	305	2	557	174401	SNCS-80
100	20 ^{+0.018}	109 ^{+1/-0.7}	18	25	41	27	30 ± 0.5	95	89	230	328	2	690	174402	SNCS-100
125	30 ^{+0.018}	132 ^{+1/-0.7}	25	37	50	30	39 ± 0.5	100	110	275	400	2	1,375	174403	SNCS-125

1) Corrosion resistance class 2 as per Festo standard 940 070

Components subject to moderate corrosion stress. Externally visible parts with primarily decorative surface requirements which are in direct contact with a normal industrial environment or media such as coolants or lubricating agents.

Swivel flange SNCL

Material:

Die-cast aluminium

Free of copper and PTFE

RoHS-compliant

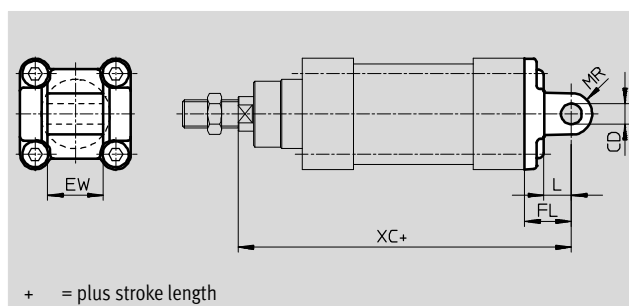

+ = plus stroke length



Dimensions and ordering data											
For \varnothing	CD	EW	FL	L	MR	XC		CRC ¹⁾	Weight	Part No.	Type
[mm]	\varnothing		± 0.2				KP		[g]		
32	10	26	22	13	10	142	187	2	75	174404	SNCL-32
40	12	28	25	16	12	160	213	2	100	174405	SNCL-40
50	12	32	27	16	12	170	237	2	160	174406	SNCL-50
63	16	40	32	21	16	190	266	2	250	174407	SNCL-63
80	16	50	36	22	16	210	305	2	405	174408	SNCL-80
100	20	60	41	27	20	230	328	2	655	174409	SNCL-100
125	25	70	50	30	25	275	400	2	1,245	174410	SNCL-125

1) Corrosion resistance class 2 as per Festo standard 940 070

Components subject to moderate corrosion stress. Externally visible parts with primarily decorative surface requirements which are in direct contact with a normal industrial environment or media such as coolants or lubricating agents.

Standard cylinders DNC, ISO 15552

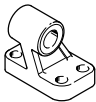
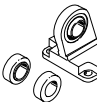
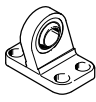

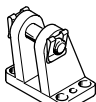
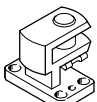



Accessories



Ordering data – Mounting attachments				Technical data → Internet: clevis foot			
Designation	For Ø	Part No.	Type	Designation	For Ø	Part No.	Type
Clevis foot LNG				Clevis foot LSN			
	32	33890	LNG-32		32	5561	LSN-32
	40	33891	LNG-40		40	5562	LSN-40
	50	33892	LNG-50		50	5563	LSN-50
	63	33893	LNG-63		63	5564	LSN-63
	80	33894	LNG-80		80	5565	LSN-80
	100	33895	LNG-100		100	5566	LSN-100
	125	33896	LNG-125		125	6987	LSN-125
Clevis foot LSNG				Clevis foot for welding LSNSG			
	32	31740	LSNG-32		32	31747	LSNSG-32
	40	31741	LSNG-40		40	31748	LSNSG-40
	50	31742	LSNG-50		50	31749	LSNSG-50
	63	31743	LSNG-63		63	31750	LSNSG-63
	80	31744	LSNG-80		80	31751	LSNSG-80
	100	31745	LSNG-100		100	31752	LSNSG-100
	125	31746	LSNG-125		125	31753	LSNSG-125
Clevis foot LBG				Right-angle clevis foot LQG			
	32	31761	LBG-32		32	31768	LQG-32
	40	31762	LBG-40		40	31769	LQG-40
	50	31763	LBG-50		50	31770	LQG-50
	63	31764	LBG-63		63	31771	LQG-63
	80	31765	LBG-80		80	31772	LQG-80
	100	31766	LBG-100		100	31773	LQG-100
	125	31767	LBG-125		125	31774	LQG-125

Ordering data – Mounting attachments, corrosion-resistant				Technical data → Internet: crlng			
Designation	For Ø	Part No.	Type	Designation	For Ø	Part No.	Type
Clevis foot CRLNG				Clevis foot CRLNG			
	32					161840	CRLNG-32
	40					161841	CRLNG-40
	50					161842	CRLNG-50
	63					161843	CRLNG-63
	80					161844	CRLNG-80
	100					161845	CRLNG-100
	125					176951	CRLNG-125

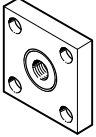
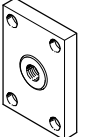
Standard cylinders DNC, ISO 15552

Accessories

Ordering data – Piston rod attachments				Technical data → Internet: piston rod attachment			
Designation	For Ø	Part No.	Type	Designation	For Ø	Part No.	Type
Rod eye SGS				Rod clevis SGA			
	32	9261	SGS-M10x1,25		32	32954	SGA-M10x1,25
	40	9262	SGS-M12x1,25		40	10767	SGA-M12x1,25
	50	9263	SGS-M16x1,5		50	10768	SGA-M16x1,5
	63						
	80	9264	SGS-M20x1,5		80	10769	SGA-M20x1,5
	100	10774	SGS-M27x2		100	10770	SGA-M27x2
	125						
Rod clevis SG				Self-aligning rod coupler FK			
	32	6144	SG-M10x1,25		32	6140	FK-M10x1,25
	40	6145	SG-M12x1,25		40	6141	FK-M12x1,25
	50	6146	SG-M16x1,5		50	6142	FK-M16x1,5
	63						
	80	6147	SG-M20x1,5	80	6143	FK-M20x1,5	
	100	14987	SG-M27x2-B	100			
	125						
Coupling piece KSG				Coupling piece KSZ			
	32	32963	KSG-M10x1,25		32	36125	KSZ-M10x1,25
	40	32964	KSG-M12x1,25		40	36126	KSZ-M12x1,25
	50	32965	KSG-M16x1,5		50	36127	KSZ-M16x1,5
	63						
	80	32966	KSG-M20x1,5		80	36128	KSZ-M20x1,5
	100	32967	KSG-M27x2		100	-	-
	125						
Adapter AD							
	32	157333	AD-M10x1,25-1/8				
		157334	AD-M10x1,25-1/4				
	40	160256	AD-M12x1,25-1/4				
		160257	AD-M12x1,25-3/8				

Ordering data – Piston rod attachments, corrosion-resistant				Technical data → Internet: crsg			
Designation	For Ø	Part No.	Type	Designation	For Ø	Part No.	Type
Rod eye CRSGS				Rod clevis CRSG			
	32	195582	CRSGS-M10x1,25		32	13569	CRSG-M10x1,25
	40	195583	CRSGS-M12x1,25		40	13570	CRSG-M12x1,25
	50	195584	CRSGS-M16x1,5		50	13571	CRSG-M16x1,5
	63						
	80	195585	CRSGS-M20x1,5		80	13572	CRSG-M20x1,5
	100	195586	CRSGS-M27x2		100	185361	CRSG-M27x2
	125						
Self-aligning rod coupler CRFK							
	32	2305778	CRFK-M10x1,25				
	40	2305779	CRFK-M12x1,25				
	50	2490673	CRFK-M16x1,5				
	63						
	80	2545677	CRFK-M20x1,5				
	100						

Standard cylinders DNC, ISO 15552

Accessories

Bellows kit DADB



General technical data							
Type DADB-V6-		32	40	50	63	80	100
Max. cylinder stroke range ¹⁾	[mm]	10 ... 500	10 ... 500	10 ... 500	10 ... 500	10 ... 500	10 ... 500
Type of mounting		Via threaded pin					
Mounting position		Any					
Resistance to media		Dust, chips, oil, grease, fuel (→ Internet: media resistance)					
Ambient temperature ²⁾	[°C]	-10 ... +80					
Protection class		IP54					
Corrosion resistance class CRC ³⁾		3					

1) In combination with the bellows kit DADB

2) Note operating range of proximity sensors and cylinder
Corrosion resistance class 3 as per Festo standard 940 070

Components with heavy corrosion exposure. Externally visible components in direct contact with normal industrial atmosphere or media such as solvents and cleaning agents, where the surface requirement is predominantly functional.

Materials

Sectional view

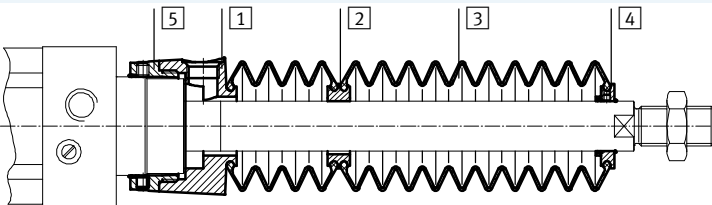

Bellows		
1	Connection	Polyamide
2	Intermediate piece	Polyamide
3	Bellows	Nitrile rubber
4	End piece	Polyamide
5	Connector	Polyamide
-	O-ring	Nitrile rubber
Note on materials		Free of copper and PTFE
		RoHS-compliant

Weight [g]							
Type DADB-V6- Stroke [mm]		32	40	50	63	80	100
10 ... 50		29	42	71	69	99	124
51 ... 125		41	56	91	89	127	152
126 ... 175		52	68	105	103	140	165
176 ... 250		66	85	129	127	193	218
251 ... 300		79	100	147	145	231	255
301 ... 350		92	115	166	164	268	293
351 ... 375		92	115	167	165	259	284
376 ... 425		104	129	185	183	296	321
426 ... 475		117	144	204	202	334	359
476 ... 500		117	144	205	203	324	349

Standard cylinders DNC, ISO 15552

Accessories

Travel velocity v as a function of tubing length l



The bellows kit is a leak-free system. To prevent unwanted media being drawn in, the supply and exhaust air must be ducted via a pressure compensation hole in the connection

part **1**. The pressure generated in the bellows kit by the positioning motion is primarily defined by travel velocity

and tubing length. The recommended tubing length based on the travel velocity of the drive can be read from the graph.

Advancing

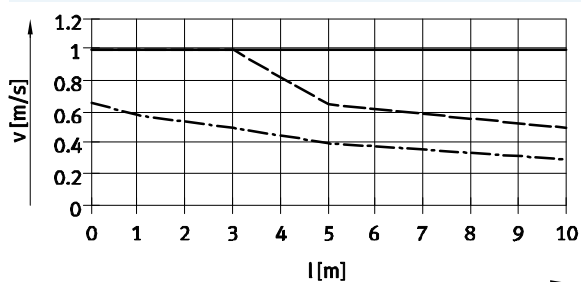

— Ø 32/50/63 - · - · - Ø 80/100
 - - - - - Ø 40

Returning

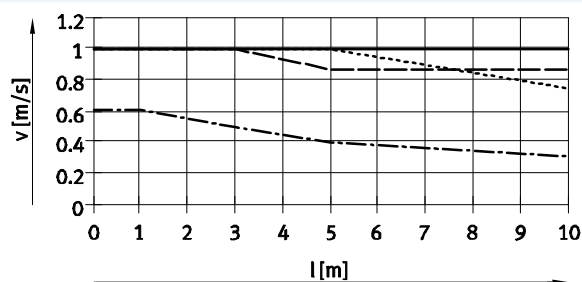

— Ø 32 - · - · - Ø 50/63
 - - - - - Ø 40 - · - · - Ø 80/100

Note
 The push-in fittings opposite must be used for the pressure compensation hole.
 Silencers can also be used as an alternative. This reduces the travel velocity slightly.

Tubing size and push-in fitting for pressure compensation hole			
Ø [mm]	Tubing O.D. [mm]	Push-in fitting	
		Part No.	Type
32, 40	8	186109	QS-G $\frac{1}{8}$ -8-I
		578376	NPQH-DK-G18-Q8-P10
		578362	QS-F-G $\frac{1}{8}$ -8H
50, 63, 80, 100	12	186350	QS-G $\frac{1}{4}$ -12
		578344	NPQH-D-G14-Q12-P10
		578366	NPQH-D-G14-S12-P10

Standard cylinders DNC, ISO 15552

Accessories

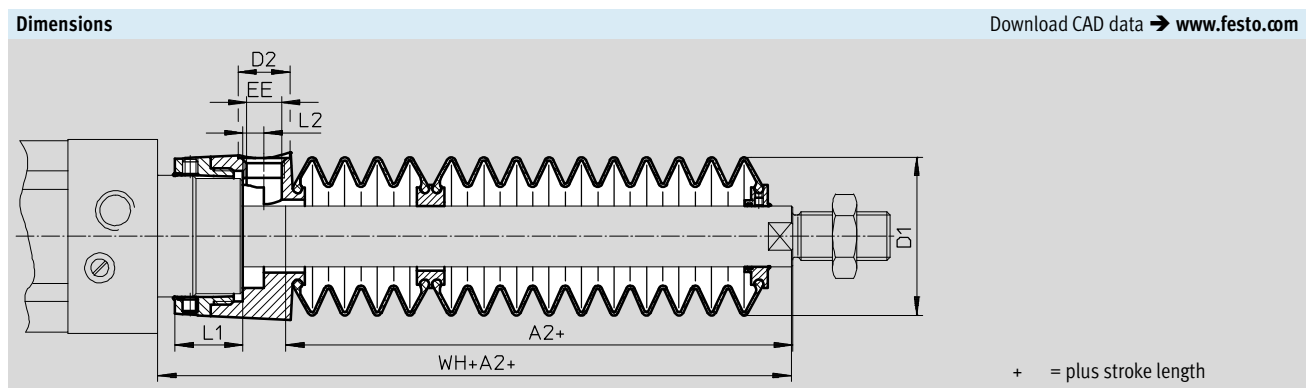

Stroke [mm]	32							40						
	A2 ¹⁾	D1 max.	D2	EE	L1	L2	WH+A2	A2 ¹⁾	D1 max.	D2	EE	L1	L2	WH+A2
10 ... 50	29	38	14	G ¹ / ₈	12.9	5.4	55	28	46	14	G ¹ / ₈	16.3	5.4	58
51 ... 125	47						73	43						73
126 ... 175	61						87	56						86
176 ... 250	80						106	72						102
251 ... 300	96						122	86						116
301 ... 350	112						138	100						130
351 ... 375	114						140	101						131
376 ... 425	130						156	115						145
426 ... 475	145						171	130						160
476 ... 500	147						173	131						161

Stroke [mm]	50							63						
	A2 ¹⁾	D1 max.	D2	EE	L1	L2	WH+A2	A2 ¹⁾	D1 max.	D2	EE	L1	L2	WH+A2
10 ... 50	28	57	17	G ¹ / ₄	22.35	7	65	28	57	17	G ¹ / ₄	22.4	7	65
51 ... 125	46						83	46						83
126 ... 175	56						93	56						93
176 ... 250	73						110	73						110
251 ... 300	86						123	86						123
301 ... 350	97						134	97						134
351 ... 375	105						142	105						142
376 ... 425	116						153	116						153
426 ... 475	126						163	126						163
476 ... 500	134						171	134						171

Stroke [mm]	80							100						
	A2 ¹⁾	D1 max.	D2	EE	L1	L2	WH+A2	A2 ¹⁾	D1 max.	D2	EE	L1	L2	WH+A2
10 ... 50	25	93	17	G ¹ / ₄	28	4	71	25	93	17	G ¹ / ₄	28	4	71
51 ... 125	37						83	37						83
126 ... 175	49						95	49						95
176 ... 250	62						108	62						108
251 ... 300	74						120	74						120
301 ... 350	86						132	86						132
351 ... 375	87						133	87						133
376 ... 425	98						144	98						144
426 ... 475	110						156	110						156
476 ... 500	111						157	111						157

1) The dimension corresponds to the K8 value (extended piston rod) of the drive

Standard cylinders DNC, ISO 15552

Accessories

Ordering data – Bellows kit

An extended piston rod (order code K8) is absolutely necessary when using a bellows kit.
 → Ordering data – Modular products.

The necessary dimension for K8 as a function of piston diameter and cylinder stroke as well as the associated bellows kit is indicated in the following table:

Order example:

Selected standard cylinder:
 DNC-32-320-PPV-A- ...
 Dimension for the corresponding K8 value (see table):
 112 mm
 Complete type designation for the standard cylinder:
 DNC-32-320-PPV-A-...-112K8
 Associated bellows kit:
 DADB-V6-32-S301-350

Cylinder data			Bellows kit		Cylinder data			Bellows kit	
∅	Stroke	Dimension for K8	Part No.	Type	∅	Stroke	Dimension for K8	Part No.	Type
[mm]	[mm]	[mm]			[mm]	[mm]	[mm]		
32	10 ... 50	29	553271	DADB-V6-32-S10-50	40	10 ... 50	28	553291	DADB-V6-40-S10-50
	51 ... 125	47	553273	DADB-V6-32-S51-125		51 ... 125	43	553293	DADB-V6-40-S51-125
	126 ... 175	61	553275	DADB-V6-32-S126-175		126 ... 175	56	553295	DADB-V6-40-S126-175
	176 ... 250	80	553277	DADB-V6-32-S176-250		176 ... 250	72	553297	DADB-V6-40-S176-250
	251 ... 300	96	553279	DADB-V6-32-S251-300		251 ... 300	86	553399	DADB-V6-40-S251-300
	301 ... 350	112	553281	DADB-V6-32-S301-350		301 ... 350	100	553301	DADB-V6-40-S301-350
	351 ... 375	114	553283	DADB-V6-32-S351-375		351 ... 375	101	553303	DADB-V6-40-S351-375
	376 ... 425	130	553285	DADB-V6-32-S376-425		376 ... 425	115	553305	DADB-V6-40-S376-425
	426 ... 475	145	553287	DADB-V6-32-S426-475		426 ... 475	130	553307	DADB-V6-40-S426-475
	476 ... 500	147	553289	DADB-V6-32-S476-500		476 ... 500	131	553309	DADB-V6-40-S476-500
50	10 ... 50	28	553311	DADB-V6-50-S10-50	63	10 ... 50	28	553331	DADB-V6-63-S10-50
	51 ... 125	46	553313	DADB-V6-50-S51-125		51 ... 125	46	553333	DADB-V6-63-S51-125
	126 ... 175	56	553315	DADB-V6-50-S126-175		126 ... 175	56	553335	DADB-V6-63-S126-175
	176 ... 250	73	553317	DADB-V6-50-S176-250		176 ... 250	73	553337	DADB-V6-63-S176-250
	251 ... 300	86	553319	DADB-V6-50-S251-300		251 ... 300	86	553339	DADB-V6-63-S251-300
	301 ... 350	97	553321	DADB-V6-50-S301-350		301 ... 350	97	553341	DADB-V6-63-S301-350
	351 ... 375	105	553323	DADB-V6-50-S351-375		351 ... 375	105	553343	DADB-V6-63-S351-375
	376 ... 425	116	553325	DADB-V6-50-S376-425		376 ... 425	116	553345	DADB-V6-63-S376-425
	426 ... 475	126	553327	DADB-V6-50-S426-475		426 ... 475	126	553347	DADB-V6-63-S426-475
	476 ... 500	134	553329	DADB-V6-50-S476-500		476 ... 500	134	553349	DADB-V6-63-S476-500
80	10 ... 50	25	553351	DADB-V6-80-S10-50	100	10 ... 50	25	553371	DADB-V6-100-S10-50
	51 ... 125	37	553353	DADB-V6-80-S51-125		51 ... 125	37	553373	DADB-V6-100-S51-125
	126 ... 175	49	553355	DADB-V6-80-S126-175		126 ... 175	49	553375	DADB-V6-100-S126-175
	176 ... 250	62	553357	DADB-V6-80-S176-250		176 ... 250	62	553377	DADB-V6-100-S176-250
	251 ... 300	74	553359	DADB-V6-80-S251-300		251 ... 300	74	553379	DADB-V6-100-S251-300
	301 ... 350	86	553361	DADB-V6-80-S301-350		301 ... 350	86	553381	DADB-V6-100-S301-350
	351 ... 375	87	553363	DADB-V6-80-S351-375		351 ... 375	87	553383	DADB-V6-100-S351-375
	376 ... 425	98	553365	DADB-V6-80-S376-425		376 ... 425	98	553385	DADB-V6-100-S376-425
	426 ... 475	110	553367	DADB-V6-80-S426-475		426 ... 475	110	553387	DADB-V6-100-S426-475
	476 ... 500	111	553369	DADB-V6-80-S476-500		476 ... 500	111	553389	DADB-V6-100-S476-500

Standard cylinders DNC, ISO 15552

Accessories

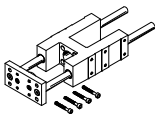
Ordering data – Guide units for fixed strokes (recirculating ball bearing guide only)				Technical data → Internet: feng		
	Stroke [mm]	Part No.	Type	Stroke [mm]	Part No.	Type
	For Ø 32 mm			For Ø 40 mm		
	10 ... 50	34493	FENG-32-50-KF	10 ... 50	34499	FENG-40-50-KF
	10 ... 100	34494	FENG-32-100-KF	10 ... 100	34500	FENG-40-100-KF
	10 ... 160	34495	FENG-32-160-KF	10 ... 160	34501	FENG-40-160-KF
	10 ... 200	34496	FENG-32-200-KF	10 ... 200	34502	FENG-40-200-KF
	10 ... 250	150289	FENG-32-250-KF	10 ... 250	34503	FENG-40-250-KF
	10 ... 320	34497	FENG-32-320-KF	10 ... 320	34504	FENG-40-320-KF
	10 ... 400	150290	FENG-32-400-KF	10 ... 400	150291	FENG-40-400-KF
	10 ... 500	34498	FENG-32-500-KF	10 ... 500	34505	FENG-40-500-KF
	For Ø 50 mm			For Ø 63 mm		
	10 ... 50	34506	FENG-50-50-KF	10 ... 50	34513	FENG-63-50-KF
	10 ... 100	34507	FENG-50-100-KF	10 ... 100	34514	FENG-63-100-KF
	10 ... 160	34508	FENG-50-160-KF	10 ... 160	34515	FENG-63-160-KF
	10 ... 200	34509	FENG-50-200-KF	10 ... 200	34516	FENG-63-200-KF
	10 ... 250	34510	FENG-50-250-KF	10 ... 250	34517	FENG-63-250-KF
	10 ... 320	34511	FENG-50-320-KF	10 ... 320	34518	FENG-63-320-KF
	10 ... 400	150292	FENG-50-400-KF	10 ... 400	34519	FENG-63-400-KF
	10 ... 500	34512	FENG-50-500-KF	10 ... 500	34520	FENG-63-500-KF
	For Ø 80 mm			For Ø 100 mm		
	10 ... 50	34521	FENG-80-50-KF	10 ... 50	34529	FENG-100-50-KF
	10 ... 100	34522	FENG-80-100-KF	10 ... 100	34530	FENG-100-100-KF
	10 ... 160	34523	FENG-80-160-KF	10 ... 160	34531	FENG-100-160-KF
	10 ... 200	34524	FENG-80-200-KF	10 ... 200	34532	FENG-100-200-KF
	10 ... 250	34525	FENG-80-250-KF	10 ... 250	34533	FENG-100-250-KF
	10 ... 320	34526	FENG-80-320-KF	10 ... 320	34534	FENG-100-320-KF
	10 ... 400	34527	FENG-80-400-KF	10 ... 400	34535	FENG-100-400-KF
	10 ... 500	34528	FENG-80-500-KF	10 ... 500	34536	FENG-100-500-KF

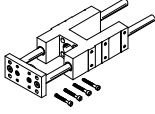

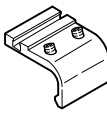
Ordering data – Guide units for variable strokes				Technical data → Internet: feng	
	For Ø [mm]	Stroke [mm]	With recirculating ball bearing guide Part No. Type	With plain-bearing guide Part No. Type	
	32	10 ... 500	34487 FENG-32-...-KF	34481 FENG-32-...	
	40	10 ... 500	34488 FENG-40-...-KF	34482 FENG-40-...	
	50	10 ... 500	34489 FENG-50-...-KF	34483 FENG-50-...	
	63	10 ... 500	34490 FENG-63-...-KF	34484 FENG-63-...	
	80	10 ... 500	34491 FENG-80-...-KF	34485 FENG-80-...	
	100	10 ... 500	34492 FENG-100-...-KF	34486 FENG-100-...	

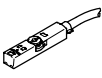
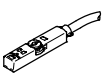

Ordering data – Mounting kits for proximity sensors SMT-8		Technical data → Internet: smb	
	For Ø [mm]	Part No.	Type
	32	175705	SMB-8-FENG-32/40
	40	175706	SMB-8-FENG-50/63
	50		
	63	175707	SMB-8-FENG-80/100
	80		
100			

Standard cylinders DNC, ISO 15552

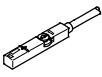
Accessories

Ordering data – Proximity sensors for T-slot, magneto-resistive						Technical data → Internet: smt	
	Type of mounting	Switch output	Electrical connection	Cable length [m]	Part No.	Type	
N/O contact							
	Insertable in the slot from above, flush with cylinder profile, short design	PNP	Cable, 3-wire	2.5	574335	SMT-8M-A-PS-24V-E-2,5-OE	
			Plug M8x1, 3-pin	0.3	574334	SMT-8M-A-PS-24V-E-0,3-M8D	
			Plug M12x1, 3-pin	0.3	574337	SMT-8M-A-PS-24V-E-0,3-M12	
		NPN	Cable, 3-wire	2.5	574338	SMT-8M-A-NS-24V-E-2,5-OE	
			Plug M8x1, 3-pin	0.3	574339	SMT-8M-A-NS-24V-E-0,3-M8D	
N/C contact							
	Insertable in the slot from above, flush with cylinder profile, short design	PNP	Cable, 3-wire	7.5	574340	SMT-8M-A-PO-24V-E-7,5-OE	

Ordering data – Proximity sensors for T-slot, magnetic reed						Technical data → Internet: sme		
	Type of mounting	Switching output	Electrical connection	Cable length [m]	Part No.	Type		
N/O contact								
	Insertable in the slot from above, flush with the cylinder profile	Contacting	Cable, 3-wire	2.5	543862	SME-8M-DS-24V-K-2,5-OE		
				5.0	543863	SME-8M-DS-24V-K-5,0-OE		
			Plug M8x1, 3-pin	Cable, 2-wire	2.5	543872	SME-8M-ZS-24V-K-2,5-OE	
				0.3	543861	SME-8M-DS-24V-K-0,3-M8D		
	Insertable in the slot lengthwise, flush with the cylinder profile	Contacting	Cable, 3-wire	2.5	150855	SME-8-K-LED-24		
			Plug M8x1, 3-pin	0.3	150857	SME-8-S-LED-24		
N/C contact								
	Insertable in the slot lengthwise, flush with the cylinder profile	Contacting	Cable, 3-wire	7.5	160251	SME-8-0-K-LED-24		

Ordering data – Connecting cables					Technical data → Internet: nebu	
	Electrical connection, left	Electrical connection, right	Cable length [m]	Part No.	Type	
	Straight socket, M8x1, 3-pin	Cable, open end, 3-wire	2.5	541333	NEBU-M8G3-K-2.5-LE3	
			5	541334	NEBU-M8G3-K-5-LE3	
	Straight socket, M12x1, 5-pin	Cable, open end, 3-wire	2.5	541363	NEBU-M12G5-K-2.5-LE3	
			5	541364	NEBU-M12G5-K-5-LE3	
	Angled socket, M8x1, 3-pin	Cable, open end, 3-wire	2.5	541338	NEBU-M8W3-K-2.5-LE3	
			5	541341	NEBU-M8W3-K-5-LE3	
	Angled socket, M12x1, 5-pin	Cable, open end, 3-wire	2.5	541367	NEBU-M12W5-K-2.5-LE3	
			5	541370	NEBU-M12W5-K-5-LE3	

Ordering data – Slot covers for T-slot				
	Assembly	Length	Part No.	Type
	Insertable from above	2x 0.5 m	151680	ABP-5-S

Standard cylinders DNC, ISO 15552

Accessories

Ordering data – One-way flow control valves			Technical data → Internet: grla		
Connection	Material		Part No.	Type	
	Thread	For tubing O.D.			
	G ¹ / ₈	3	Metal design	193142	GRLA- ¹ / ₈ -QS-3-D
		4		193143	GRLA- ¹ / ₈ -QS-4-D
		6		193144	GRLA- ¹ / ₈ -QS-6-D
		8		193145	GRLA- ¹ / ₈ -QS-8-D
	G ¹ / ₄	6		193146	GRLA- ¹ / ₄ -QS-6-D
		8		193147	GRLA- ¹ / ₄ -QS-8-D
		10		193148	GRLA- ¹ / ₄ -QS-10-D
		G ³ / ₈		6	193149
	8			193150	GRLA- ³ / ₈ -QS-8-D
	10			193151	GRLA- ³ / ₈ -QS-10-D
	G ¹ / ₂			12	193152