

Standard cylinders DSBC, to ISO 15552

FESTO

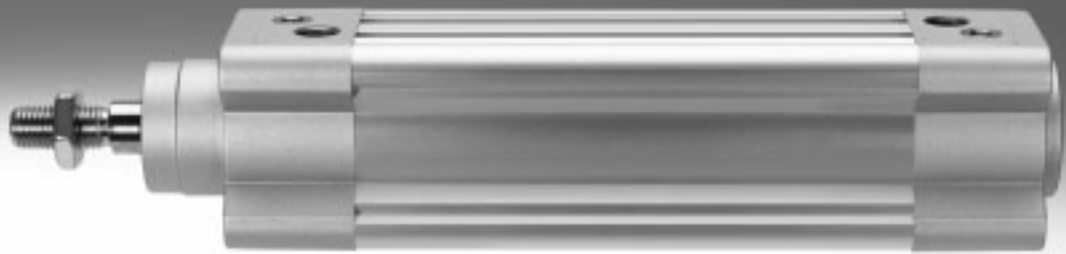

Standard cylinders DSBC, to ISO 15552

Key features

At a glance



DIN



- Standards-based cylinders to ISO 15552 (corresponds to the withdrawn standards ISO 6431, DIN ISO 6431, VDMA 24 562, NF E 49 003.1 and UNI 10290)

- Double-acting
- For contactless position sensing
- Optionally with protection against rotation
- Extensive range of accessories makes it possible to install the cylinder virtually anywhere

- Three types of cushioning available:
 - P cushioning: elastic cushioning rings/pads at both ends
 - PPS cushioning: pneumatic cushioning, self-adjusting at both ends
 - PPV cushioning: pneumatic cushioning, adjustable at both ends

- The variants can be configured individually thanks to the modular product system
- Excellent flexibility thanks to the wide range of variants

DSBC-...-C – With clamping unit, standard hole pattern

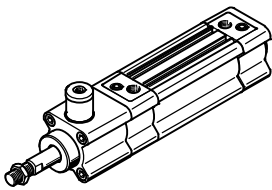

- Standard hole pattern
- Holding or clamping the piston rod in any position
- Piston rod can be held in position for long periods even with alternating loads, fluctuating operating pressure or leaks in the system

Additional measures are required for use in safety-related applications; in Europe, for example, the standards listed under the EC Machinery Directive must be observed.

Without additional measures in accordance with statutory minimum requirements, the product is not suitable for use in safety-related sections of control systems.

DSBC-...-E1/-E2/-E3 – With end-position locking, standard hole pattern

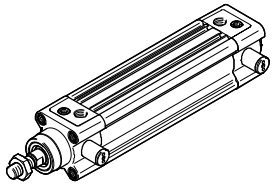

- Standard hole pattern
- Positive locking in the end position as a drop guard. In the event of a pressure drop, the piston rod is locked in its end position
- Either at one or both ends

Additional measures are required for use in safety-related applications; in Europe, for example, the standards listed under the EC Machinery Directive must be observed.

Without additional measures in accordance with statutory minimum requirements, the product is not suitable for use in safety-related sections of control systems.

DSBC-...-P2 – With protective bellows kit DADB, standard hole pattern

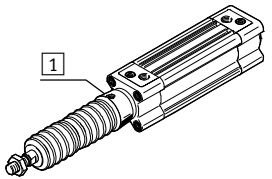

The protective bellows kit is a leak-free system. To prevent unwanted media from being drawn in, the supply and exhaust air must be ducted via a pressure compensation hole in the

connection part **1**. The kit protects the piston rod, seal and bearings against a wide variety of media, for example:

- Dust
- Chippings
- Oil
- Grease
- Fuel

Ordering the protective bellows kit

An extended piston rod is absolutely essential if a protective bellows kit is to be used.

The protective bellows kit can be ordered via the modular product system or as an accessory. The following must be noted in this case:

Ordering via the modular product system:

The protective bellows kit is supplied mounted on the bearing cap using feature P2. The required piston rod extension is automatically taken into consideration. This means that there is no need to specify a value for the feature ...E.

Ordering as an accessory:

If the protective bellows kit is ordered as an accessory, the required value → 48 must be entered for the feature ...E in the modular product system.

Standard cylinders DSBC, to ISO 15552

Key features

DSBC-... D3 – Sensor slots on 3 sides

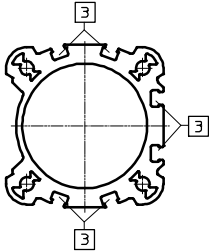

The piston position can be sensed on three sides of the drive if the feature D3 is selected in the modular product system.

 Sensor slot for proximity sensor

Position sensing/force control

With position transmitter SMAT-8M

→ 55



Analogue positional feedback possible

- Analogue output 0 ... 10 V

With proportional pressure regulator VPPM



Infinite adjustment of the gripping force possible

- Setpoint input
 - 0 ... 10 V
 - 4 ... 20 mA

Optional accessories

Mounting kit DAVM

→ 50

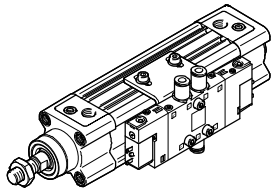

- For lateral valve assembly, directly on the drive
- Particularly suitable for decentralised use in larger systems
- Mounting is only possible on the side on which the pneumatic connections are located

Standard cylinders DSBC, to ISO 15552

Key features

Application examples





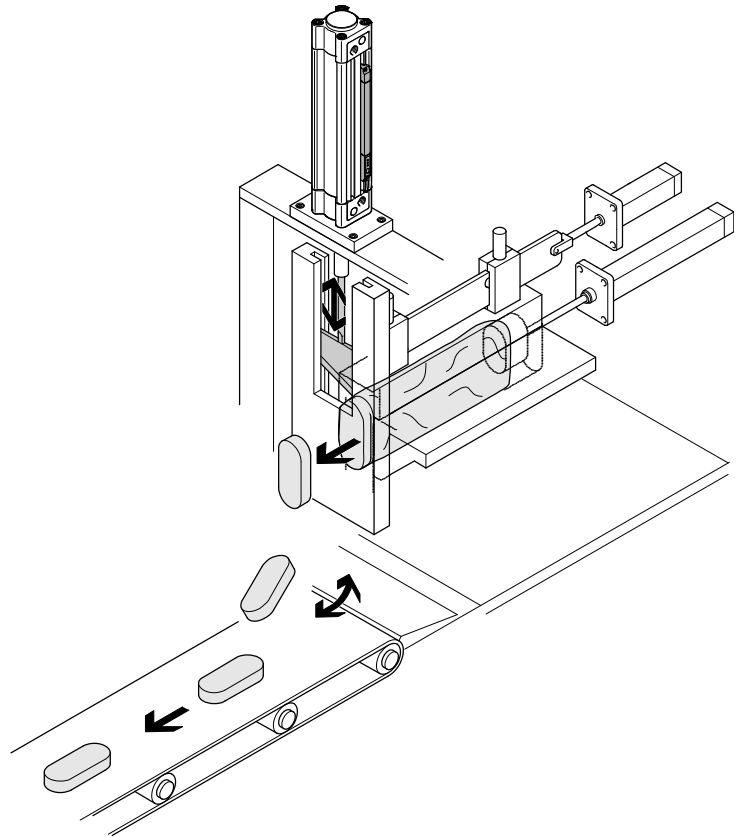
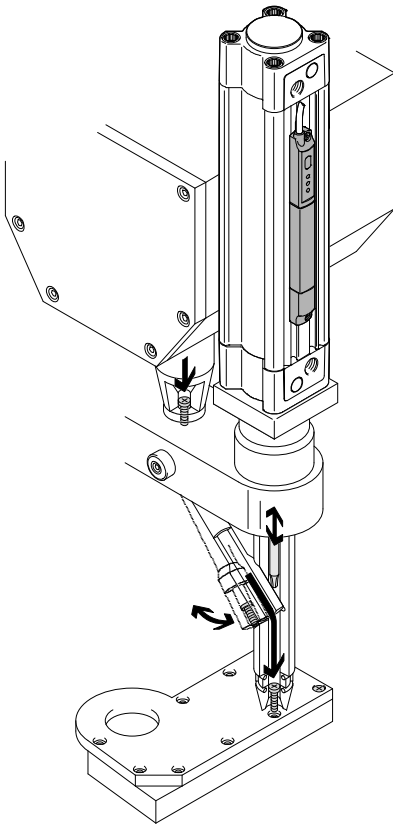







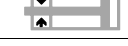

Automatic screw machine

For process control

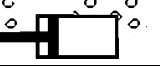
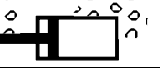

Standard cylinders DSBC, to ISO 15552

Key features

Variants from the modular product system		
Symbol	Features	Description
	Q Square piston rod	Protection against rotation. For correctly oriented feeding
	C Clamping unit	Integrated clamping unit on the piston rod
	E1/E2/ E3 With end-position locking	Positive locking in the end position as a drop guard. If there is a drop in pressure, the piston rod is secured in its end position to prevent it from dropping
	L Low friction	At high piston speeds, considerably greater efficiency than other versions. The special materials considerably reduce system wear. Low-friction movements are therefore possible, especially during rapid stroke movements. Seal contains silicone grease
	U Uniform, slow movement	Low break-away pressure, suitable for slow stroke movements at a constant, judder-free speed over the full stroke range. Seal contains silicone grease
	T Through piston rod	For working at both ends with the same force in the forward and return stroke, for attaching external stops
	F Female piston rod thread	–
	R3 High corrosion protection	All external cylinder surfaces comply with corrosion resistance class 3 to Festo standard 940 070. The piston rod is made from corrosion and acid-resistant steel
	T1 Heat-resistant seals	Temperature range 0 ... +120 °C
	T3 Low temperature	Temperature range –40 ... +80 °C
	T4 Heat-resistant seals	Temperature range 0 ... +150 °C
	A1 Wiper seal variant	Increased chemical resistance: For longer service life, e.g. when using cooling lubricants.
	A2 Wiper seal variant	Hard wiper seal: The cylinder is equipped with a hard-chrome plated piston rod and a rigid wiper seal, which protects against dry, dusty media
	A3 Wiper seal variant	Unlubricated operation: Cleaning processes degrease the piston rod. A special piston rod seal designed for unlubricated operation permits a longer service life compared to the standard seal
	...E Piston rod extension	–
	...L Piston rod thread extension	–

Standard cylinders DSBC, to ISO 15552

Product range overview

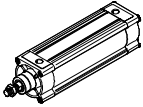
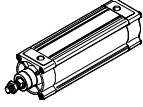
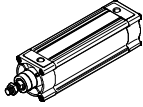
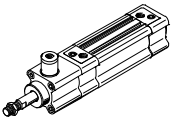
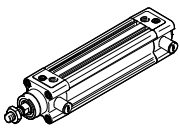
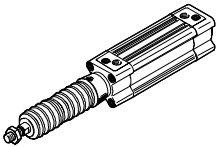
Function	Design	Type	Piston Ø	Stroke	Through piston rod	Female piston rod thread	Sensor slot on three sides	Cushioning			
			[mm]	[mm]							T
Double-acting	DSBC-...										
		DSBC-...	32, 40, 50, 63, 80, 100, 125	1 ... 2,800	■	■	■	■	■	■	■
	DSBC-...-Q – With protection against rotation										
		DSBC-...-Q	32, 40, 50, 63, 80, 100	1 ... 1,500	■	■	■	■	■	■	■
	DSBC-...-L/-U – With special running characteristics										
		DSBC-...-L	32, 40, 50, 63, 80, 100	1 ... 2,800	-	■	■	■	■	■	■
		DSBC-...-U	32, 40, 50, 63, 80, 100, 125	1 ... 2,800	-	■	■	■	■	■	■
	DSBC-...-C – With clamping unit, standard hole pattern										
		DSBC-...-C	32, 40, 50, 63, 80, 100, 125	10 ... 2,000	■	■	■	■	■	■	■
	DSBC-...-E1/-E2/-E3 – With end-position locking, standard hole pattern										
	DSBC-...-E1/-E2/-E3	32, 40, 50, 63, 80, 100	10 ... 2,000	-	■	■	■	-	■	■	
DSBC-...-P2 – With bellows, standard hole pattern											
	DSBC-...-P2	32, 40, 50, 63, 80, 100	10 ... 500	■	■	■	■	■	■	■	

Standard cylinders DSBC, to ISO 15552

Product range overview

Type	Position sensing	High corrosion protection	Temperature range 0 ... +120 °C	Temperature range -40 ... +80 °C	Temperature range 0 ... +150 °C	Wiper seal variant increased chemical resistance	Wiper seal variant hard scraper (ring)	Wiper seal variant For unlubricated operation	EU certification	Piston rod extension	Piston rod thread extension
	A	R3	T1	T3	T4	A1	A2	A3	EX4	...E	...L
DSBC-...											
DSBC-...	■	■	■	■	■	■	■	■	■	■	■
DSBC-...-Q – With protection against rotation											
DSBC-...-Q	■	■	■	-	-	-	-	-	■	■	■
DSBC-...-L/-U – With special running characteristics											
DSBC-...-L	■	-	-	-	-	-	-	-	-	■	■
DSBC-...-U	■	-	-	-	-	-	-	-	-	■	■
DSBC-...-C – With clamping unit, standard hole pattern											
DSBC-...-C	■	-	-	-	-	-	-	-	-	■	■
DSBC-...-E1/-E2/-E3 – With end-position locking, standard hole pattern											
DSBC-...-E1/ -E2/-E3	■	-	-	-	-	-	-	-	-	■	■
DSBC-...-P2 – With bellows, standard hole pattern											
DSBC-...-P2	■	■	-	-	-	-	-	-	-	■	■

Standard cylinders DSBC, to ISO 15552

Peripherals overview

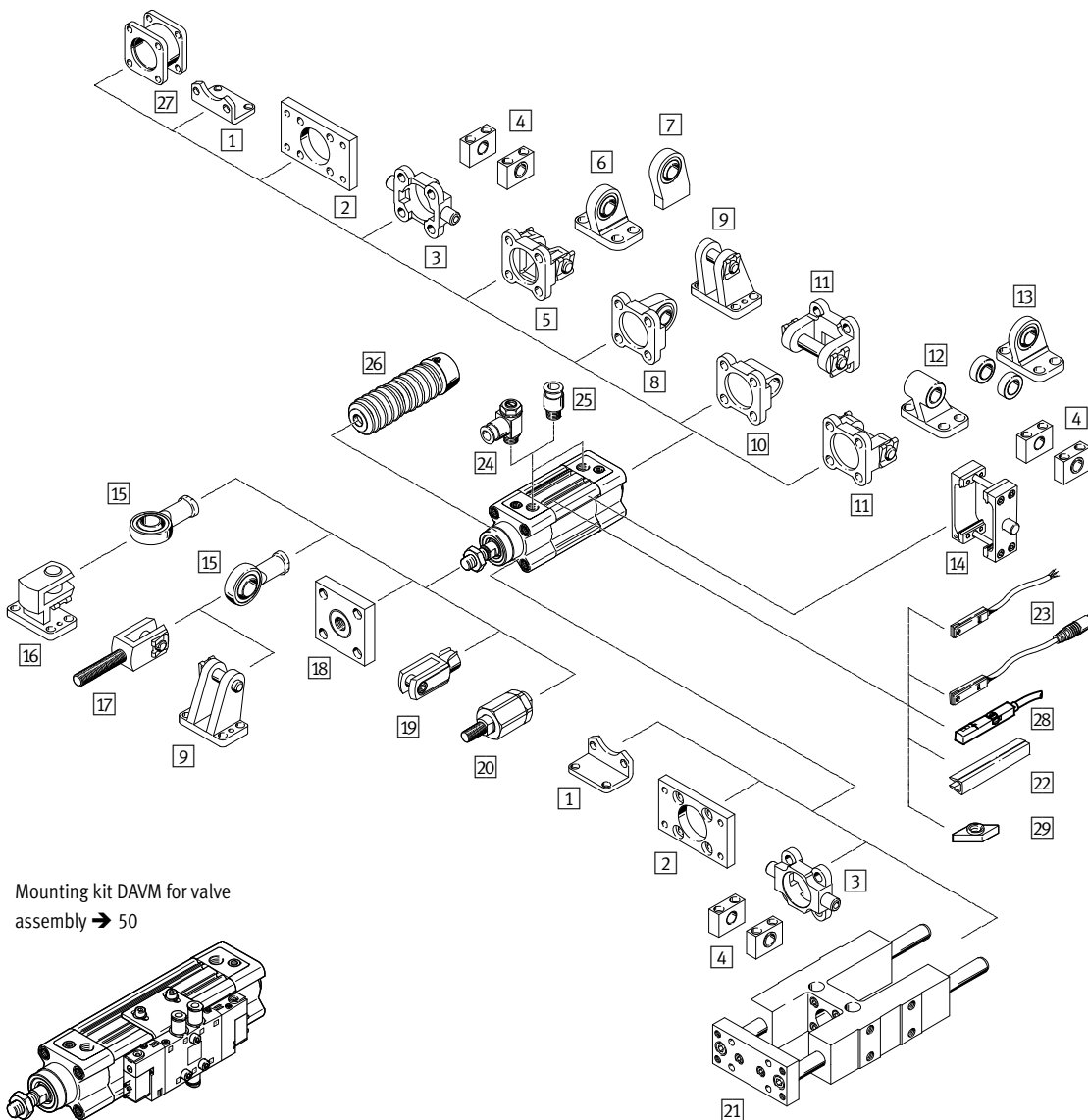

Mounting kit DAVM for valve assembly → 50

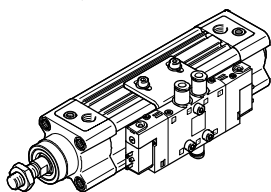

Mounting components and accessories		Brief description	DSBC...					→ Page/ Internet
				-L	-U	-C	-E1/ -E2/ -E3	
1	Foot mounting HNC/CRHNC	For bearing or end caps	■	■	■	■	■	34
2	Flange mounting FNC/CRFNG	- For bearing or end caps - Cannot be used on the bearing cap in combination with protective bellows kit DADB	■	■	■	■	■	35
3	Trunnion flange ZNCF/CRZNG	- For bearing or end caps - Cannot be used on the bearing cap in combination with protective bellows kit DADB	■	■	■	■ ¹⁾	■	36
4	Trunnion support LNZG/CRLNZG	-	■	■	■	■ ¹⁾	■	37
5	Swivel flange SNC	For end caps	■	■	■	■	-	38

1) Cannot be mounted in combination with E1.
Can only be mounted on the end cap in combination with E2.
Can only be mounted on the bearing cap in combination with E3.

Standard cylinders DSBC, to ISO 15552

Peripherals overview

Mounting attachments and accessories									
	Brief description	DSBC-...					→ Page/ Internet		
			-L	-U	-C	-E1/ -E2/ -E3		-T	
6	Clevis foot LSNG	With spherical bearing	■	■	■	■	■	-	43
7	Clevis foot LSNSG	Weld-on, with spherical bearing	■	■	■	■	■	-	43
8	Swivel flange SNCS	With spherical bearing for end caps	■	■	■	■	■	-	40
9	Clevis foot LBG	-	■	■	■	■	■	-	43
10	Swivel flange SNCL	For end caps	■	■	■	■	■	-	41
11	Swivel flange SNCB/SNCB-...-R3	For end caps	■	■	■	■	■	-	39
12	Clevis foot LNG/CRLNG	-	■	■	■	■	■	-	43
13	Clevis foot LSN	With spherical bearing	■	■	■	■	■	-	43
14	Trunnion mounting kit DAMT	For mounting anywhere along the cylinder profile barrel	■	■	■	■	■	■	42
15	Rod eye SGS/CRSGS	With spherical bearing	■	■	■	■	■	■	44
16	Right-angle clevis foot LQG	-	■	■	■	■	■	■	43
17	Rod clevis SGA	With male thread	■	■	■	■	■	■	44
18	Coupling piece KSG	To compensate for radial deviations	■	■	■	■	■	■	44
	Coupling piece KSZ	For cylinders with a non-rotating piston rod to compensate for radial deviations	■	■	■	■	■	■	44
19	Rod clevis SG/CRSG	Permits a swivelling movement of the cylinder in one plane	■	■	■	■	■	■	44
20	Self-aligning rod coupler FK/CRFK	For compensating radial and angular deviations	■	■	■	■	■	■	44
21	Guide unit FENG	For protecting standard cylinders against rotation at high torque loads	■	■	■	■	-	■	53
22	Slot cover ABP-5-S	For protecting the sensor cable and keeping dirt out of the sensor slots	■	■	■	■	■	■	139
23	Proximity sensor SME/SMT-8M	Can be integrated in the cylinder profile barrel	■	■	■	■	■	■	54
24	One-way flow control valve GRLA	For regulating speed	■	■	■	■	■	■	grla
25	Push-in fitting QS	For connecting compressed air tubing with standard O.D.	■	■	■	■	■	■	quick star
26	Protective bellows kit DADB	- Protects the cylinder (piston rod, seal and bearings) against a wide range of media and thus prevents premature wear - The kit can only be used in combination with an extended piston rod (E)	■	-	-	-	-	■	45
27	Multi-position kit DPNC	For connecting two cylinders with identical piston diameters to form a multi-position cylinder	■	■	■	■	■	■	49
28	Position transmitter SMAT-8M	- Continuously senses the position of the piston - It has an analogue output	■	■	■	■	■	■	55
29	Slot nut ABAN	Insertable in the slot from above	■	■	■	■	■	■	139

Standard cylinders DSBC, to ISO 15552

Technical data

Function
P cushioning

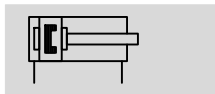

PPV cushioning

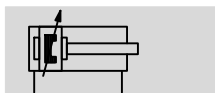

PPS cushioning

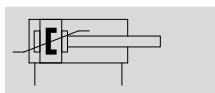

DIN



Ø - Diameter
32 ... 125 mm

— - Stroke length
1 ... 2,800 mm

www.festo.com



General technical data								
Piston Ø		32	40	50	63	80	100	125
Pneumatic connection								
DSBC-...		G $\frac{1}{8}$	G $\frac{1}{4}$	G $\frac{1}{4}$	G $\frac{3}{8}$	G $\frac{3}{8}$	G $\frac{1}{2}$	G $\frac{1}{2}$
DSBC-...-C		M5	G $\frac{1}{8}$	G $\frac{1}{8}$	G $\frac{1}{8}$	G $\frac{1}{8}$	G $\frac{1}{8}$	G $\frac{1}{8}$
Piston rod thread		M10x1.25	M12x1.25	M16x1.5	M16x1.5	M20x1.5	M20x1.5	M27x2
Stroke								
DSBC-...	[mm]	1 ... 2,800						
DSBC-...-Q	[mm]	1 ... 1,500						-
DSBC-...-C	[mm]	10 ... 2,000						
DSBC-...-E1/-E2/-E3	[mm]	10 ... 2,000						-
DSBC-...-P2	[mm]	10 ... 500						-
DSBC-...-...E	[mm]	1 ... 2,000						
DSBC-...-...L	[mm]	1 ... 2,000						
Design		Piston / piston rod / profile barrel						
Mode of operation		Double-acting						
Cushioning								
DSBC-...-P		Elastic cushioning rings/pads at both ends						
DSBC-...-PPV		Pneumatic cushioning, adjustable at both ends						
DSBC-...-PPS		Pneumatic cushioning, self-adjusting at both ends						
Cushioning length								
DSBC-...-PPV	[mm]	17	19	22	22	31	31	45
DSBC-...-E1/-E2/-E3	[mm]	17	19	15	15	15	15	-
Position sensing		Via proximity sensor						
Type of mounting		Via internal thread / accessories						
Mounting position		Any						

Operating and environmental conditions								
Piston Ø		32	40	50	63	80	100	125
Operating medium		Compressed air to ISO 8573-1:2010 [7:4:4]						
Note on operating/pilot medium		Lubricated operation possible (in which case lubricated operation will always be required)						
Operating pressure								
DSBC-...	[bar]	0.6 ... 12		0.4 ... 12			0.2 ... 10	
DSBC-...-L ¹⁾	[bar]	0.3 ... 12	0.25 ... 12		0.2 ... 12		0.15 ... 12	-
DSBC-...-U ¹⁾	[bar]	0.25 ... 12		0.2 ... 12	0.15 ... 12	0.1 ... 12		0.1 ... 10
DSBC-...-C ²⁾	[bar]	1.5 ... 10						
DSBC-...-E1/-E2/-E3	[bar]	2.5 ... 12		1.5 ... 12			-	
DSBC-...-T3/-A2	[bar]	1 ... 12						1 ... 10
DSBC-...-A3	[bar]	1.5 ... 12		1 ... 12	0.6 ... 12		0.6 ... 10	

1) Values only applicable for strokes ≤ 500 mm
In combination with cushioning PPS/PPV, the specifications only apply outside the cushioning range

2) Min. Note min. release pressure → 14

Standard cylinders DSBC, to ISO 15552

Technical data

Operating and environmental conditions								
Piston Ø		32	40	50	63	80	100	125
Ambient temperature ¹⁾								
DSBC-...	[°C]	-20 ... +80						
DSBC-...-L/-A1	[°C]	0 ... +80						
DSBC-...-C	[°C]	-10 ... +80						
DSBC-...-T1	[°C]	0 ... +120						
DSBC-...-T3	[°C]	-40 ... +80						
DSBC-...-T4	[°C]	0 ... +150						
DSBC-...-P2	[°C]	-10 ... +80						-
DSBC-...-EX4	[°C]	-20 ... +60						
Corrosion resistance class CRC								
DSBC-...		2 ²⁾						
DSBC-...-R3		3 ³⁾						

- 1) Note operating range of proximity sensors.
- 2) Corrosion resistance class 2 according to Festo standard 940 070
Components subject to moderate corrosion stress. Externally visible parts with primarily decorative surface requirements which are in direct contact with a normal industrial environment or media such as coolants or lubricating agents.
- 3) Corrosion resistance class 3 according to Festo standard 940 070
Components subject to high corrosion stress. Externally visible parts with primarily functional surface requirements which are in direct contact with a normal industrial environment or media such as solvents and cleaning agents.

ATEX ¹⁾	
Explosion-proof ambient temperature	-20°C ≤ Ta ≤ +60°C
CE marking (see declaration of conformity)	To EU Explosion Protection Directive (ATEX)
ATEX category for gas	II 2G
Explosion ignition protection type for gas	c T4
ATEX category for dust	II 2D
Explosion ignition protection type for dust	c T120°C

- 1) Note the ATEX certification of the accessories.

Forces [N] and impact energy [J]								
Piston Ø		32	40	50	63	80	100	125
Theoretical force at 6 bar, advancing		483	754	1,178	1,870	3,016	4,712	7,363
Theoretical force at 6 bar, retracting		415	633	990	1,682	2,721	4,418	6,881
Max. impact energy in the end positions								
DSBC-...		0.4 ¹⁾	0.7	1.0	1.3	1.8	2.5	3.3
DSBC-...-L/-U/-T1/-T3/-T4		0.2 ¹⁾	0.35	0.5	0.65	0.9	1.25	1.65

- 1) The max. energy in combination with the trunnion mounting kit DAMT is 0.1 J.

Permissible impact velocity

$$v_{perm.} = \sqrt{\frac{2 \times E_{perm.}}{m_{Intrinsic} + m_{Load}}}$$

Maximum permissible load:

$$m_{Load} = \frac{2 \times E_{perm.}}{v^2} - m_{Intrinsic}$$

$v_{perm.}$ Permissible impact velocity
 $E_{perm.}$ Maximum impact energy
 $m_{Intrinsic}$ Moving mass (drive)
 m_{Load} Moving payload

Standard cylinders DSBC, to ISO 15552

Technical data

Technical data DSBC-...-C – With clamping unit

- The specified holding force refers to a static load. If this value is exceeded, slippage may occur. Dynamic forces occurring during operation must not exceed the static holding force. The clamping unit is not backlash-free in the clamped condition if varying loads are applied to the piston rod.
- The clamping unit may only be released if the forces at the piston have reached equilibrium. Otherwise, there is a risk of accidents due to sudden movement of the piston rod. Blocking off the air supply at both ends (e.g. with a 5/3-way valve) does not provide any safety.

Piston Ø		32	40	50	63	80	100	125
Clamping type with effective direction		At both ends						
		Clamping via spring force						
		Release through compressed air						
Static holding force	[N]	600	1,000	1,400	2,000	5,000	5,000	7,500
Max. axial play under load	[mm]	0.5	0.5	0.8	0.8	0.8	0.8	1.8
Min. release pressure	[bar]	3						

Technical data DSBC-...-E1/-E2/-E3 – With end-position locking

- End-position locking should only be operated in conjunction with double-acting cylinders with exhaust air flow control in order to ensure that the lock is always completely released prior to starting the drive movement.
- The end-position locking may only be released if the forces at the piston have reached equilibrium. Otherwise, there is a risk of accidents due to sudden movement of the piston rod. Blocking off the air supply at both ends (e.g. with a 5/3-way valve) does not provide any safety.
- Locking can be performed from any stroke position once the drive is brought mechanically into its end position.
- An excessive end-position cushioning setting (more than 50% closed) can result in the locking bolt not engaging reliably, resulting in premature wear.
- The exhaust hole must not be closed.

Piston Ø		32	40	50	63	80	100
Clamping type		Positive locking through stop cylinder					
		Release through compressed air					
Static holding force	[N]	500	500	2,000	2,000	5,000	5,000
Max. axial backlash with end position locked	[mm]	1.3	1.3	1.3	1.5	1.5	1.5
Min. unlocking pressure	[bar]	≤ 2.5		≤ 1.5			
Max. locking pressure	[bar]	≥ 0.5					

Sizing example

When sizing pneumatic cylinders it is recommended as a basic principle that only 50% of the indicated theoretical forces (see above) be used.

Given:
 Installation position = vertical
 Workpiece load = 44 kg
 $F = m \times g = 44 \text{ kg} \times 9.81 \text{ m/s}^2 = 431.6 \text{ N}$

To be found:
 Suitable piston Ø

Example with 32 mm piston Ø:

Theoretical force at 6 bar, advancing = 483 N
 50% of the theoretical force = 241.5 N
 Static holding force with 32 mm piston Ø = 500 N
 The static holding force of end-position locking is within the permissible range (max. 500 N) for a workpiece load of 44 kg (431.6 N), however the cylinder would be at 89% capacity.

Result:
 A cylinder with a piston Ø of 40 mm is therefore recommended for this application.

Standard cylinders DSBC, to ISO 15552

Technical data

FESTO

Max. lateral force F_q as a function of stroke length l

Horizontal mounting

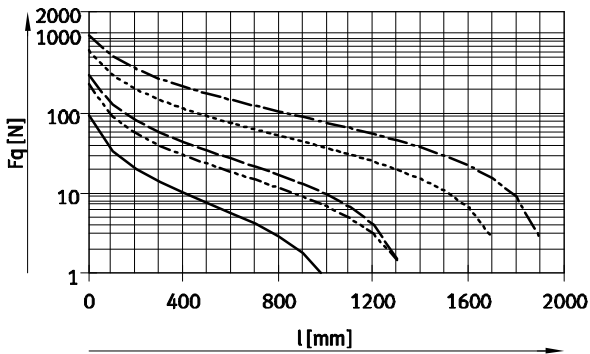

——— ∅ 32 - - - - - ∅ 80/100
 - - - - - ∅ 40 - - - - - ∅ 125
 - - - - - ∅ 50/63

Vertical mounting

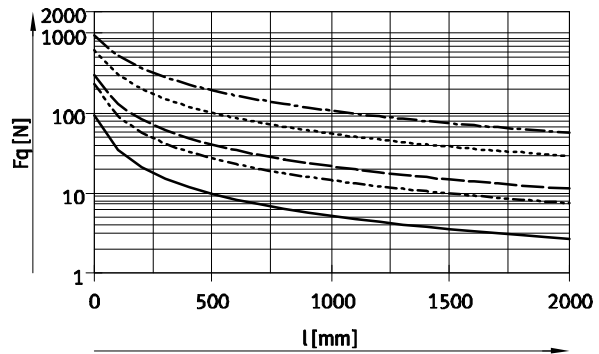

——— ∅ 32 - - - - - ∅ 80/100
 - - - - - ∅ 40 - - - - - ∅ 125
 - - - - - ∅ 50/63

Permissible torsional backlash with variant Q – With protection against rotation

Piston ∅	32	40	50	63	80	100
Torsional backlash [°]	±0.65	±0.6	±0.45	±0.45	±0.45	±0.45

Weight [g]

Piston ∅	32	40	50	63	80	100	125
DSBC-...							
Product weight with 0 mm stroke	465	740	1,190	1,740	2,660	3,665	6,611
Additional weight per 10 mm stroke	27	37	56	62	92	101	151
Moving mass with 0 mm stroke	110	205	365	430	810	1,000	2,245
Moving mass per 10 mm stroke	9	16	25	25	39	39	63
DSBC-...-Q							
Product weight with 0 mm stroke	503	755	1,241	1,821	2,717	3,827	-
Additional weight per 10 mm stroke	25	30	51	57	87	95	-
Moving load with 0 mm stroke	115	170	332	391	757	890	-
Moving mass per 10 mm stroke	8	11	20	20	31	31	-
DSBC-...-C							
Product weight with 0 mm stroke	745	1,175	1,940	2,920	5,075	6,965	12,860
Additional weight per 10 mm stroke	25	35	56	62	95	103	151
Moving mass with 0 mm stroke	160	290	540	620	1,200	1,425	3,035
Moving mass per 10 mm stroke	9	16	25	25	39	39	63
DSBC-...-E1/-E2/-E3							
Product weight with 0 mm stroke							
DSBC-...-E1	505	780	1,312	1,862	3,018	4,023	-
DSBC-...-E2	485	760	1,251	1,801	2,839	3,844	-
DSBC-...-E3	485	760	1,251	1,801	2,839	3,844	-
Additional weight per 10 mm stroke	27	37	56	62	92	101	-
Moving load with 0 mm stroke	110	205	365	430	810	1,000	-
Moving mass per 10 mm stroke	9	16	25	25	39	39	-
DSBC-...-T							
Product weight with 0 mm stroke	581	924	1,523	2,103	3,243	4,353	7,450
Additional weight per 10 mm stroke	34	50	81	86	133	141	214
Moving mass with 0 mm stroke	181	339	613	684	1,292	1,516	3,084
Moving mass per 10 mm stroke	18	32	50	50	78	78	126

Standard cylinders DSBC, to ISO 15552

Technical data

Max. lateral force Fq as a function of stroke length l and lever arm s

Q – With protection against rotation

Ø 32

Max. torque = 800 Nmm/max. stroke = 300 mm

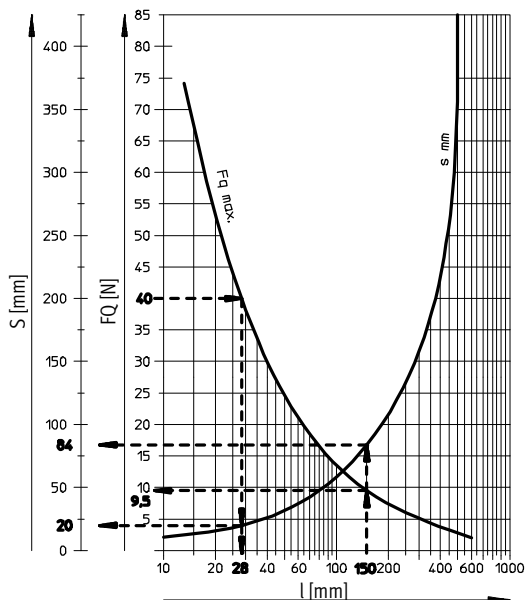

Ø 40

Max. torque = 1,100 Nmm/max. stroke = 400 mm

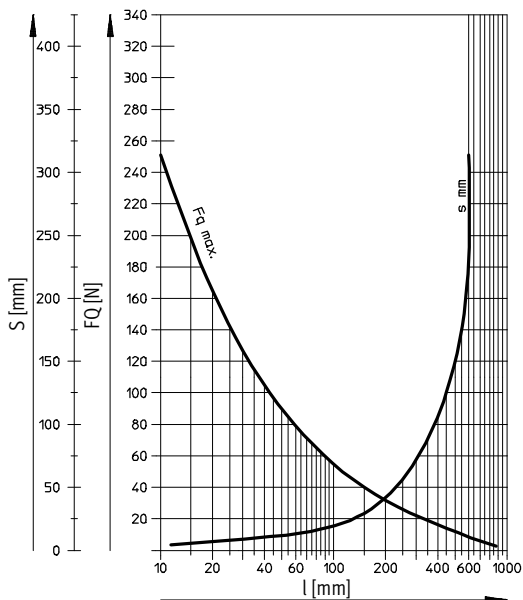

Ø 50/63

Max. torque = 1,500 Nmm/max. stroke = 500 mm

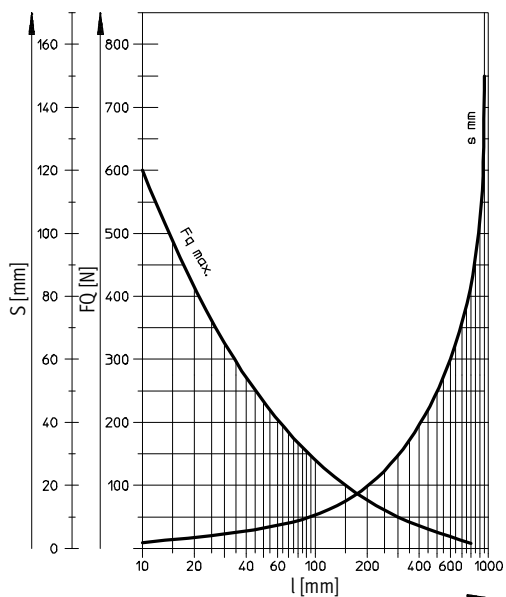

Ø 80/100

Max. torque = 3,000 Nmm/max. stroke = 600 mm

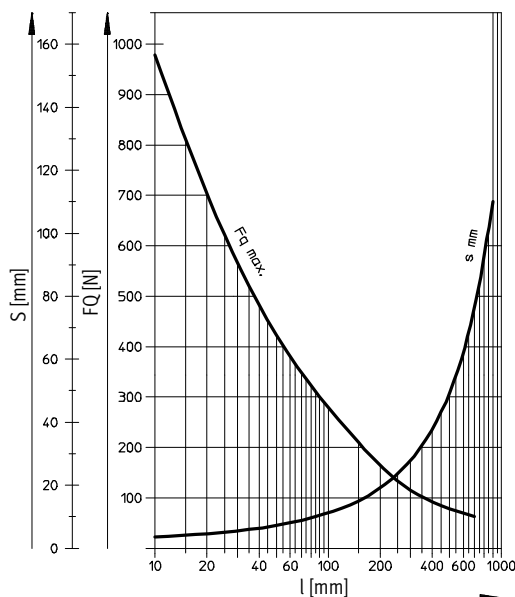

Examples for piston Ø 32 mm

Example 1:

Stroke length l = 150 mm

Result: Permissible

lateral force Fq = 9.5 N

Lever arm s = 84 mm

Example 2:

Lateral force Fq = 40 N

Result: Permissible

stroke length l = 28 mm

Lever arm s = 20 mm

Example 3:

Stroke length l = 150 mm

Lever arm s = 100 mm

$Fq = \frac{\text{Max. torque } 800 \text{ Nmm}}{\text{Lever arm } 100 \text{ mm}}$

= 8 N

Result: Permissible

$Fq = 8 \text{ N} < Fq_{\text{max.}} = 9.5 \text{ N}$

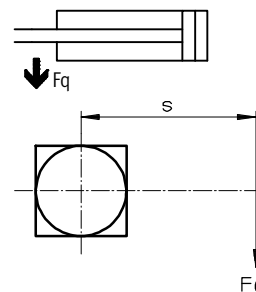

Standard cylinders DSBC, to ISO 15552

Technical data

Materials

Sectional view – Basic design

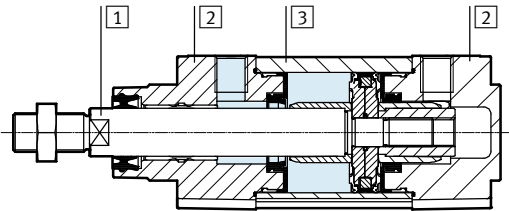

With clamping unit

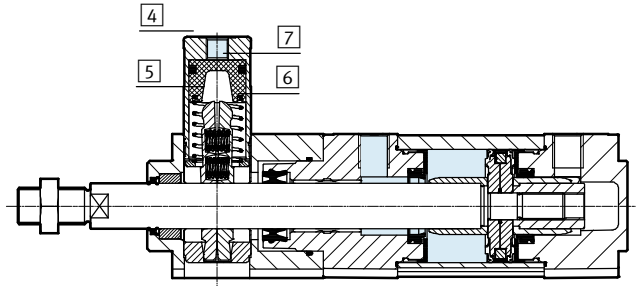

With end-position locking

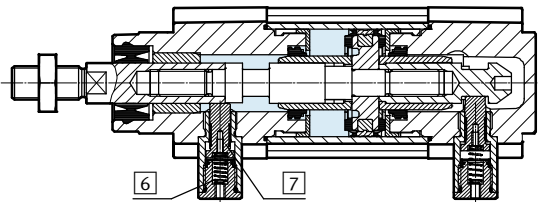

Standard cylinder

1	Piston rod	
	DSBC-...	High-alloy steel
	DSBC-...-R3	High-alloy stainless steel
	DSBC-...-A2	Hard-chromium plated tempered steel
2	Cover	Die-cast aluminium, coated
3	Profile barrel	Anodised wrought aluminium alloy
4	Housing, clamping unit	Anodised wrought aluminium alloy
5	Clamping jaw	Brass
6	Spring	
	DSBC-...-C	Spring steel
	DSBC-...-E1/E2/E3	High-alloy stainless steel
7	Piston	
	DSBC-...-C	Aluminium
	DSBC-...-E1/E2/E3	Hardened steel
-	Piston rod seal	
	DSBC-...	PUR
	DSBC-...-T1/-T4/-A1	FPM
	DSBC-...-T3	Low-temperature polyurethane
	DSBC-...-A3	UHMW-PE
Cushioning seal	DSBC-...	PUR
	DSBC-...-T1/-T4	FPM
	DSBC-...-T3	Low-temperature polyurethane
Cushioning boss	DSBC-...	POM
	DSBC-...-T1/-T3/-T4	Aluminium
Note on materials	DSBC-...	RoHS-compliant
	DSBC-...-L/U/-T3/-T4/-A3	Contains PWIS (paint-wetting impairment substances)

Standard cylinders DSBC, to ISO 15552

Technical data

Dimensions

Download CAD data → www.festo.com

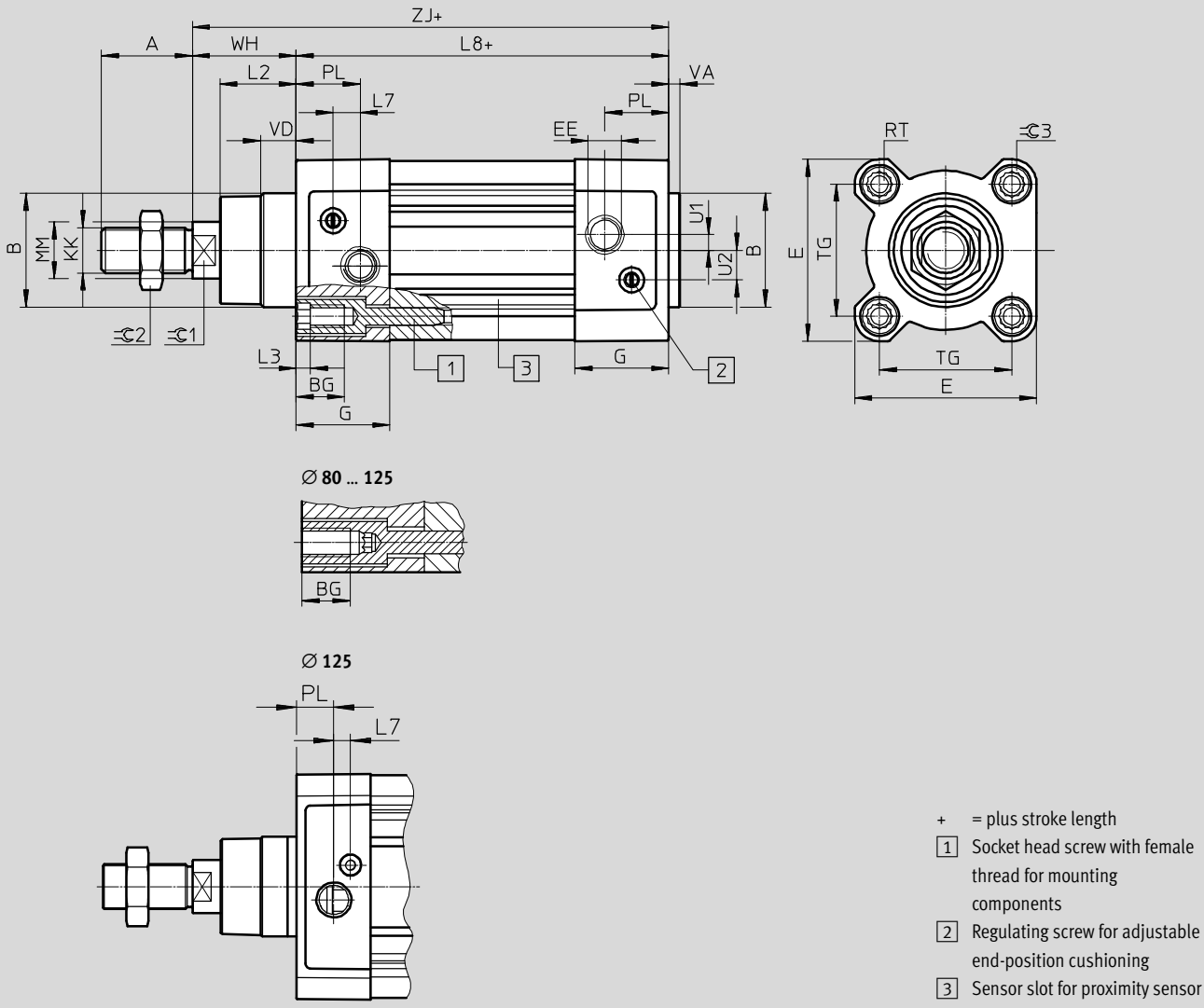

Variant

T – Through piston rod

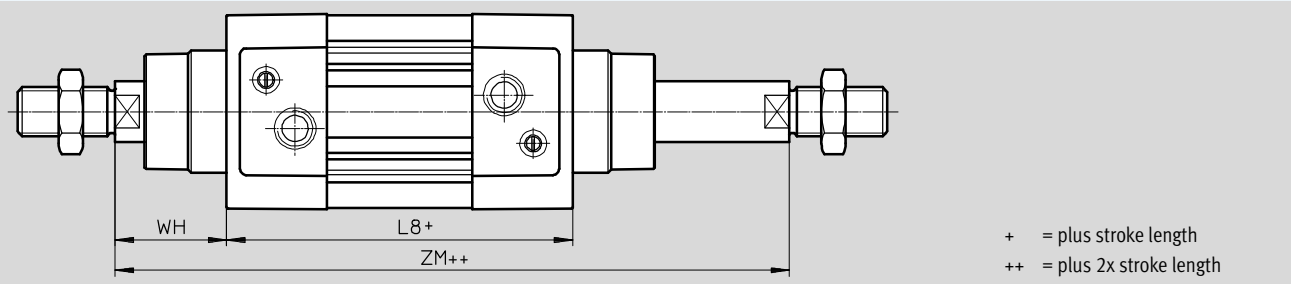

Standard cylinders DSBC, to ISO 15552

Technical data

∅ [mm]	A -0.5	B ∅ d11	BG min.	E +0.5	EE	G -0.2	U2 ±0.1	U1 ±0.1	KK
32	22	30	16	45	G1/8	28	5.7	5.25	M10x1.25
40	24	35	16	54	G1/4	33	8	4	M12x1.25
50	32	40	16	64	G1/4	33	10.4	5.5	M16x1.5
63	32	45	16	75	G3/8	40.5	12.75	6.25	M16x1.5
80	40	45	17	93	G3/8	43	12.5	8	M20x1.5
100	40	55	17	110	G1/2	48	13.5	10	M20x1.5
125	54	60	20	136	G1/2	44.7	13	8	M27x2

∅ [mm]	L2	L3 max.	L7	L8 ±0.4	MM ∅	PL ±0.1	RT	TG ±0.3
32	18 _{-0.2}	5	6.5	94	12	19.5	M6	32.5
40	21.3 _{-0.2}	5	7.5	105	16	22.5	M6	38
50	26.8 _{-0.2}	5	9.5	106	20	22.5	M8	46.5
63	27 _{-0.2}	5	9	121	20	27.5	M8	56.5
80	34.2 _{-0.2}	-	11	128	25	30	M10	72
100	38 _{-0.2}	-	7.5	138	25	31.5	M10	89
125	45.5 _{-0.3}	-	10	160	32	22.5	M12	110

∅ [mm]	VA	VD +0.5	WH +2.2	ZJ +1.8	ZM +1	≈C1	≈C2	≈C3
32	4 _{-0.2}	10	25	119.1	146.1	10	16	6
40	4 _{-0.2}	10.5	28.7	133.9	164.8	13	18	6
50	4 _{-0.2}	11.5	35.6	141.8	179.8	17	24	8
63	4 _{-0.2}	15	35.9	157.1	195.4	17	24	8
80	4 _{-0.2}	15.7	45.4	173.6	221	22	30	6
100	4 _{-0.2}	19.2	49.3	187.5	238.8	22	30	6
125	6 _{-0.3}	20.5	64.1	225	290	27	41	8

Standard cylinders DSBC, to ISO 15552

Technical data

Dimensions – Variants

Download CAD data → www.festo.com

Q – With protection against rotation

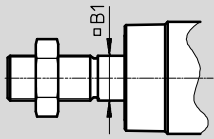

- - Note
In combination with variant T, the piston rod is protected against rotation at one end.

F – Female thread

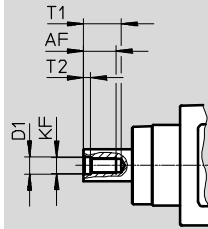

- - Note
In combination with variant T, the piston rod has female threads at both ends.

...E – Piston rod extension

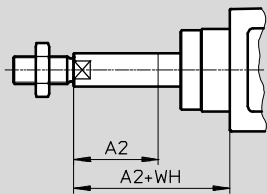

- - Note
Piston rod extension at one end in combination with the variant T.
In combination with variants T and Q, the piston rod is only extended on the square piston rod.

...L – Piston rod thread extension

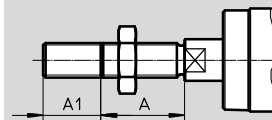

- - Note
In combination with variant T, the piston rod thread is extended at both ends.

D3 – Sensor slot on 3 sides

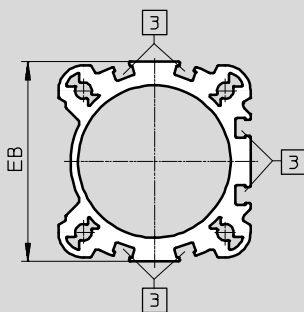

Sensor slot for proximity sensor

Standard cylinders DSBC, to ISO 15552

Technical data

∅ [mm]	A	A1		A2		AF min.
		min.	max.	min.	max.	
32	22	1	35	1	500	12
40	24	1	35	1	500	12
50	32	1	70	1	500	16
63	32	1	70	1	500	16
80	40	1	70	1	500	20
100	40	1	70	1	500	20
125	54	1	70	1	500	32

∅ [mm]	B1	D1	EB	KF	T1	T2	WH
					Max.		2.2
32	10	6.4	47 _{-0.3}	M6	16	2.6	25
40	12	8.4	54.8 ^{+0.3}	M8	16	3.3	28.7
50	16	10.5	65.5 ^{+0.3/-0.05}	M10	21	4.7	35.6
63	16	10.5	76 ₋₁	M10	21	4.7	35.9
80	20	13	92 _{-0.5}	M12	26.5	6.1	45.4
100	20	13	109 _{-0.5}	M12	26.5	6.1	49.3
125	-	17	132 ^{+0.8}	M16	40	8	64.1

Standard cylinders DSBC, to ISO 15552

Technical data

Dimensions – Variants

Download CAD data → www.festo.com

C – Clamping unit

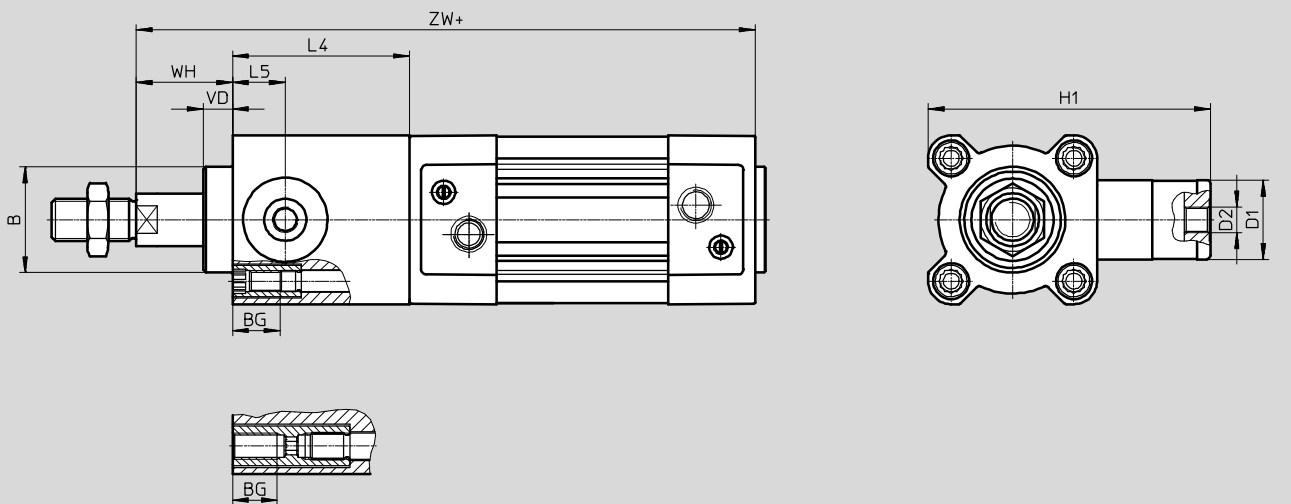

Note

The clamping unit can only be selected with variant T in combination with variant Q.

The clamping unit is mounted on the round piston rod end in combination with variants T and Q.

+ = plus stroke length

∅ [mm]	B ∅ d11	BG	D1	D2	H1	L4 ±0.2	L5	VD	WH	ZW ±1.8
32	30	16	20	M5	67	45	14	11.5	26	164.1
40	35	16	24	G1/8	88	53	16	11.5	30	186.9
50	40	16	30	G1/8	107	67	20	11	37	208.8
63	45	16	38	G1/8	123	76	24	11	37	233.1
80	45	17	48	G1/8	165	95	31.5	12.5	46	268.6
100	55	17	48	G1/8	174	98	31	12	51	285.7
125	60	20	65	G1/8	208	125	42	27.5	65	349.3

Standard cylinders DSBC, to ISO 15552

Technical data

Dimensions – Variants

Download CAD data → www.festo.com

E1/E2/E3 – End-position locking

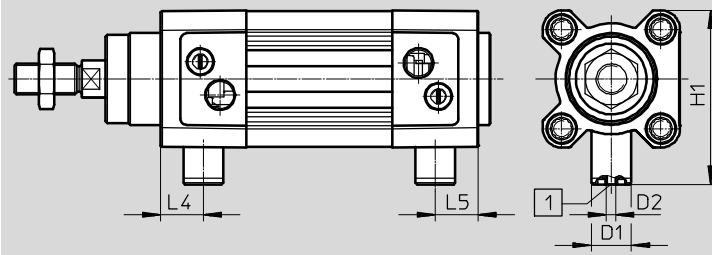

Note
 1 The connection is used for the manual interlock and/or ducted exhaust air. It must not be sealed or pressurised.

E1 – End-position locking at both ends

∅	D1 ∅	D2	H1	L4	L5
[mm]					
32	13	M3	57.5	14	14
40	13	M3	64	17	17
50	20	M5	78.5	18	18
63	20	M5	84.5	25	25
80	30	M5	105	22	22
100	30	M5	113.5	25.5	25.5

E2 – End-position locking with advanced piston rod

∅	D1 ∅	D2	H1	L4
[mm]				
32	13	M3	57.5	14
40	13	M3	64	17
50	20	M5	78.5	18
63	20	M5	84.5	25
80	30	M5	105	22
100	30	M5	113.5	25.5

E3 – End-position locking with retracted piston rod

∅	D1 ∅	D2	H1	L5
[mm]				
32	13	M3	57.5	14
40	13	M3	64	17
50	20	M5	78.5	18
63	20	M5	84.5	25
80	30	M5	105	22
100	30	M5	113.5	25.5

Standard cylinders DSBC, to ISO 15552

Technical data

Dimensions – Variants

Download CAD data → www.festo.com

P2 – Bellows on bearing cap

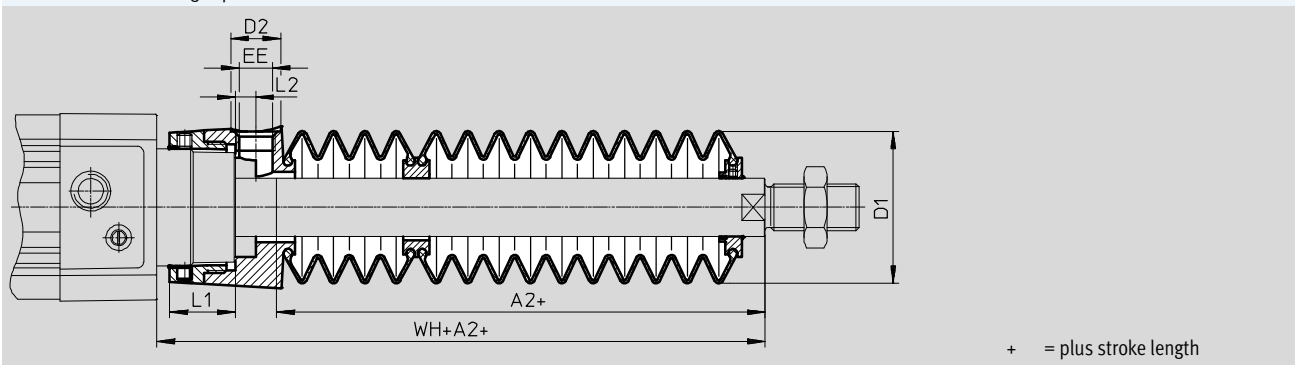

Ø Stroke [mm]	32							40						
	A2 ¹⁾	D1 max.	D2	EE	L1	L2	WH+A2	A2 ¹⁾	D1 max.	D2	EE	L1	L2	WH+A2
10 ... 50	29	38	14	G ¹ / ₈	12.9	5.4	55	28	46	14	G ¹ / ₈	16.3	5.4	56.7
51 ... 125	47						73	43						71.7
126 ... 175	61						87	56						84.7
176 ... 250	80						106	72						100.7
251 ... 300	96						122	86						114.7
301 ... 350	112						138	100						128.7
351 ... 375	114						140	101						129.7
376 ... 425	130						156	115						143.7
426 ... 475	145						171	130						158.7
476 ... 500	147						173	131						159.7

Ø Stroke [mm]	50							63						
	A2 ¹⁾	D1 max.	D2	EE	L1	L2	WH+A2	A2 ¹⁾	D1 max.	D2	EE	L1	L2	WH+A2
10 ... 50	28	57	17	G ¹ / ₄	22.35	7	63.6	28	57	17	G ¹ / ₄	22.4	7	63.9
51 ... 125	46						81.6	46						81.9
126 ... 175	56						91.6	56						91.9
176 ... 250	73						108.6	73						108.9
251 ... 300	86						121.6	86						121.9
301 ... 350	97						132.6	97						132.9
351 ... 375	105						140.6	105						140.9
376 ... 425	116						151.6	116						151.9
426 ... 475	126						161.6	126						161.9
476 ... 500	134						169.6	134						169.9

1) The dimension corresponds to the E value (piston rod extension) of the drive

Standard cylinders DSBC, to ISO 15552

Technical data

Ø Stroke [mm]	80							100						
	A2 ¹⁾	D1 max.	D2	EE	L1	L2	WH+A2	A2 ¹⁾	D1 max.	D2	EE	L1	L2	WH+A2
10 ... 50	25	93	17	G¼	28	4	70.4	25	93	17	G¼	28	4	74.3
51 ... 125	37						82.4	37						86.3
126 ... 175	49						94.4	49						98.3
176 ... 250	62						107.4	62						111.3
251 ... 300	74						119.4	74						123.3
301 ... 350	86						131.4	86						135.3
351 ... 375	87						132.4	87						136.3
376 ... 425	98						143.4	98						147.3
426 ... 475	110						155.4	110						159.3
476 ... 500	111						156.4	111						160.3

1) The dimension corresponds to the E value (piston rod extension) of the drive

Standard cylinders DSBC, to ISO 15552

Technical data

Ordering data – Standard design					
Piston Ø [mm]	Stroke [mm]	With PPV cushioning		With PPS cushioning	
		Part No.	Type	Part No.	Type
32	20	2123069	DSBC-32-20-PPVA-N3	2123085	DSBC-32-20-PPSA-N3
	25	1376422	DSBC-32-25-PPVA-N3	1376467	DSBC-32-25-PPSA-N3
	30	2123070	DSBC-32-30-PPVA-N3	2123086	DSBC-32-30-PPSA-N3
	40	1376423	DSBC-32-40-PPVA-N3	1376468	DSBC-32-40-PPSA-N3
	50	1376424	DSBC-32-50-PPVA-N3	1376469	DSBC-32-50-PPSA-N3
	60	2123071	DSBC-32-60-PPVA-N3	2123087	DSBC-32-60-PPSA-N3
	70	2123072	DSBC-32-70-PPVA-N3	2123088	DSBC-32-70-PPSA-N3
	80	1376425	DSBC-32-80-PPVA-N3	1376470	DSBC-32-80-PPSA-N3
	100	1376426	DSBC-32-100-PPVA-N3	1376471	DSBC-32-100-PPSA-N3
	125	1376427	DSBC-32-125-PPVA-N3	1376472	DSBC-32-125-PPSA-N3
	150	2123073	DSBC-32-150-PPVA-N3	2123089	DSBC-32-150-PPSA-N3
	160	1376428	DSBC-32-160-PPVA-N3	1376473	DSBC-32-160-PPSA-N3
	200	1376429	DSBC-32-200-PPVA-N3	1376474	DSBC-32-200-PPSA-N3
	250	1376430	DSBC-32-250-PPVA-N3	1376475	DSBC-32-250-PPSA-N3
	300	2123074	DSBC-32-300-PPVA-N3	2123090	DSBC-32-300-PPSA-N3
	320	1376431	DSBC-32-320-PPVA-N3	1376476	DSBC-32-320-PPSA-N3
	400	1376432	DSBC-32-400-PPVA-N3	1376477	DSBC-32-400-PPSA-N3
	500	1376433	DSBC-32-500-PPVA-N3	1376478	DSBC-32-500-PPSA-N3
1 ... 2,800	1463254	DSBC-32-...-PPVA-N3	1463252	DSBC-32-...-PPSA-N3	
40	20	2123166	DSBC-40-20-PPVA-N3	2123780	DSBC-40-20-PPSA-N3
	25	1376656	DSBC-40-25-PPVA-N3	1376903	DSBC-40-25-PPSA-N3
	30	2123167	DSBC-40-30-PPVA-N3	2123781	DSBC-40-30-PPSA-N3
	40	1376657	DSBC-40-40-PPVA-N3	1376904	DSBC-40-40-PPSA-N3
	50	1376658	DSBC-40-50-PPVA-N3	1376905	DSBC-40-50-PPSA-N3
	60	2123224	DSBC-40-60-PPVA-N3	2123782	DSBC-40-60-PPSA-N3
	70	2123225	DSBC-40-70-PPVA-N3	2123783	DSBC-40-70-PPSA-N3
	80	1376659	DSBC-40-80-PPVA-N3	1376906	DSBC-40-80-PPSA-N3
	100	1376660	DSBC-40-100-PPVA-N3	1376907	DSBC-40-100-PPSA-N3
	125	1376661	DSBC-40-125-PPVA-N3	1376908	DSBC-40-125-PPSA-N3
	150	2123226	DSBC-40-150-PPVA-N3	2123784	DSBC-40-150-PPSA-N3
	160	1376662	DSBC-40-160-PPVA-N3	1376909	DSBC-40-160-PPSA-N3
	200	1376663	DSBC-40-200-PPVA-N3	1376910	DSBC-40-200-PPSA-N3
	250	1376664	DSBC-40-250-PPVA-N3	1376911	DSBC-40-250-PPSA-N3
	300	2123227	DSBC-40-300-PPVA-N3	2123785	DSBC-40-300-PPSA-N3
	320	1376665	DSBC-40-320-PPVA-N3	1376912	DSBC-40-320-PPSA-N3
	400	1376666	DSBC-40-400-PPVA-N3	1376913	DSBC-40-400-PPSA-N3
	500	1376667	DSBC-40-500-PPVA-N3	1376914	DSBC-40-500-PPSA-N3
1 ... 2,800	1462834	DSBC-40-...-PPVA-N3	1462835	DSBC-40-...-PPSA-N3	

 Note

Other variants in the modular product system → 30

Standard cylinders DSBC, to ISO 15552

Technical data

Ordering data – Standard design					
Piston Ø [mm]	Stroke [mm]	With PPV cushioning		With PPS cushioning	
		Part No.	Type	Part No.	Type
50	20	2098969	DSBC-50-20-PPVA-N3	2102628	DSBC-50-20-PPSA-N3
	25	1366948	DSBC-50-25-PPVA-N3	1376301	DSBC-50-25-PPSA-N3
	30	2098970	DSBC-50-30-PPVA-N3	2102629	DSBC-50-30-PPSA-N3
	40	1366949	DSBC-50-40-PPVA-N3	1376304	DSBC-50-40-PPSA-N3
	50	1366950	DSBC-50-50-PPVA-N3	1376305	DSBC-50-50-PPSA-N3
	60	2098972	DSBC-50-60-PPVA-N3	2102630	DSBC-50-60-PPSA-N3
	70	2098973	DSBC-50-70-PPVA-N3	2102631	DSBC-50-70-PPSA-N3
	80	1366951	DSBC-50-80-PPVA-N3	1376306	DSBC-50-80-PPSA-N3
	100	1366952	DSBC-50-100-PPVA-N3	1376307	DSBC-50-100-PPSA-N3
	125	1366953	DSBC-50-125-PPVA-N3	1376308	DSBC-50-125-PPSA-N3
	150	2098974	DSBC-50-150-PPVA-N3	2102632	DSBC-50-150-PPSA-N3
	160	1366954	DSBC-50-160-PPVA-N3	1376309	DSBC-50-160-PPSA-N3
	200	1366955	DSBC-50-200-PPVA-N3	1376310	DSBC-50-200-PPSA-N3
	250	1366956	DSBC-50-250-PPVA-N3	1376311	DSBC-50-250-PPSA-N3
	300	2098975	DSBC-50-300-PPVA-N3	2102633	DSBC-50-300-PPSA-N3
	320	1366957	DSBC-50-320-PPVA-N3	1376312	DSBC-50-320-PPSA-N3
	400	1366958	DSBC-50-400-PPVA-N3	1376313	DSBC-50-400-PPSA-N3
500	1366959	DSBC-50-500-PPVA-N3	1376314	DSBC-50-500-PPSA-N3	
1 ... 2,800	1463766	DSBC-50-...-PPVA-N3	1463768	DSBC-50-...-PPSA-N3	
63	20	2125490	DSBC-63-20-PPVA-N3	2126684	DSBC-63-20-PPSA-N3
	25	1383578	DSBC-63-25-PPVA-N3	1383632	DSBC-63-25-PPSA-N3
	30	2125491	DSBC-63-30-PPVA-N3	2126685	DSBC-63-30-PPSA-N3
	40	1383579	DSBC-63-40-PPVA-N3	1383633	DSBC-63-40-PPSA-N3
	50	1383580	DSBC-63-50-PPVA-N3	1383634	DSBC-63-50-PPSA-N3
	60	2125492	DSBC-63-60-PPVA-N3	2126686	DSBC-63-60-PPSA-N3
	70	2125493	DSBC-63-70-PPVA-N3	2126687	DSBC-63-70-PPSA-N3
	80	1383581	DSBC-63-80-PPVA-N3	1383635	DSBC-63-80-PPSA-N3
	100	1383582	DSBC-63-100-PPVA-N3	1383636	DSBC-63-100-PPSA-N3
	125	1383583	DSBC-63-125-PPVA-N3	1383637	DSBC-63-125-PPSA-N3
	150	2125494	DSBC-63-150-PPVA-N3	2126688	DSBC-63-150-PPSA-N3
	160	1383584	DSBC-63-160-PPVA-N3	1383638	DSBC-63-160-PPSA-N3
	200	1383585	DSBC-63-200-PPVA-N3	1383639	DSBC-63-200-PPSA-N3
	250	1383586	DSBC-63-250-PPVA-N3	1383640	DSBC-63-250-PPSA-N3
	300	2125495	DSBC-63-300-PPVA-N3	2126689	DSBC-63-300-PPSA-N3
	320	1383587	DSBC-63-320-PPVA-N3	1383641	DSBC-63-320-PPSA-N3
	400	1383588	DSBC-63-400-PPVA-N3	1383642	DSBC-63-400-PPSA-N3
500	1383589	DSBC-63-500-PPVA-N3	1383643	DSBC-63-500-PPSA-N3	
1 ... 2,800	1463483	DSBC-63-...-PPVA-N3	1463481	DSBC-63-...-PPSA-N3	

 Note
Other variants in the modular product system → 30

Standard cylinders DSBC, to ISO 15552

Technical data

Ordering data – Standard design					
Piston Ø [mm]	Stroke [mm]	With PPV cushioning		With PPS cushioning	
		Part No.	Type	Part No.	Type
80	20	2126594	DSBC-80-20-PPVA-N3	2126636	DSBC-80-20-PPSA-N3
	25	1383333	DSBC-80-25-PPVA-N3	1383366	DSBC-80-25-PPSA-N3
	30	2126595	DSBC-80-30-PPVA-N3	2126637	DSBC-80-30-PPSA-N3
	40	1383334	DSBC-80-40-PPVA-N3	1383367	DSBC-80-40-PPSA-N3
	50	1383335	DSBC-80-50-PPVA-N3	1383368	DSBC-80-50-PPSA-N3
	60	2126597	DSBC-80-60-PPVA-N3	2126638	DSBC-80-60-PPSA-N3
	70	2126598	DSBC-80-70-PPVA-N3	2126639	DSBC-80-70-PPSA-N3
	80	1383336	DSBC-80-80-PPVA-N3	1383369	DSBC-80-80-PPSA-N3
	100	1383337	DSBC-80-100-PPVA-N3	1383370	DSBC-80-100-PPSA-N3
	125	1383338	DSBC-80-125-PPVA-N3	1383371	DSBC-80-125-PPSA-N3
	150	2126599	DSBC-80-150-PPVA-N3	2126640	DSBC-80-150-PPSA-N3
	160	1383339	DSBC-80-160-PPVA-N3	1383372	DSBC-80-160-PPSA-N3
	200	1383340	DSBC-80-200-PPVA-N3	1383373	DSBC-80-200-PPSA-N3
	250	1383341	DSBC-80-250-PPVA-N3	1383374	DSBC-80-250-PPSA-N3
	300	2126600	DSBC-80-300-PPVA-N3	2126641	DSBC-80-300-PPSA-N3
	320	1383342	DSBC-80-320-PPVA-N3	1383375	DSBC-80-320-PPSA-N3
400	1383343	DSBC-80-400-PPVA-N3	1383376	DSBC-80-400-PPSA-N3	
500	1383344	DSBC-80-500-PPVA-N3	1383377	DSBC-80-500-PPSA-N3	
1 ... 2,800	1463504	DSBC-80-...-PPVA-N3	1463500	DSBC-80-...-PPSA-N3	
100	25	1384804	DSBC-100-25-PPVA-N3	1384890	DSBC-100-25-PPSA-N3
	40	1384805	DSBC-100-40-PPVA-N3	1384891	DSBC-100-40-PPSA-N3
	50	1384806	DSBC-100-50-PPVA-N3	1384892	DSBC-100-50-PPSA-N3
	80	1384807	DSBC-100-80-PPVA-N3	1384893	DSBC-100-80-PPSA-N3
	100	1384808	DSBC-100-100-PPVA-N3	1384894	DSBC-100-100-PPSA-N3
	125	1384809	DSBC-100-125-PPVA-N3	1384895	DSBC-100-125-PPSA-N3
	160	1384810	DSBC-100-160-PPVA-N3	1384896	DSBC-100-160-PPSA-N3
	200	1384811	DSBC-100-200-PPVA-N3	1384897	DSBC-100-200-PPSA-N3
	250	1384812	DSBC-100-250-PPVA-N3	1384898	DSBC-100-250-PPSA-N3
	320	1384813	DSBC-100-320-PPVA-N3	1384899	DSBC-100-320-PPSA-N3
	400	1384814	DSBC-100-400-PPVA-N3	1384900	DSBC-100-400-PPSA-N3
	500	1384815	DSBC-100-500-PPVA-N3	1384901	DSBC-100-500-PPSA-N3
	1 ... 2,800	1463598	DSBC-100-...-PPVA-N3	1463558	DSBC-100-...-PPSA-N3

 Note
Other variants in the modular product system → 30

Standard cylinders DSBC, to ISO 15552

Technical data

Ordering data – Standard design					
Piston Ø [mm]	Stroke [mm]	With PPV cushioning		With PPS cushioning	
		Part No.	Type	Part No.	Type
125	25	1804956	DSBC-125-25-PPVA-N3	1804661	DSBC-125-25-PPSA-N3
	40	1804957	DSBC-125-40-PPVA-N3	1804662	DSBC-125-40-PPSA-N3
	50	1804958	DSBC-125-50-PPVA-N3	1804663	DSBC-125-50-PPSA-N3
	80	1804959	DSBC-125-80-PPVA-N3	1804664	DSBC-125-80-PPSA-N3
	100	1804960	DSBC-125-100-PPVA-N3	1804665	DSBC-125-100-PPSA-N3
	125	1804961	DSBC-125-125-PPVA-N3	1804666	DSBC-125-125-PPSA-N3
	160	1804962	DSBC-125-160-PPVA-N3	1804667	DSBC-125-160-PPSA-N3
	200	1804963	DSBC-125-200-PPVA-N3	1804668	DSBC-125-200-PPSA-N3
	250	1804964	DSBC-125-250-PPVA-N3	1804669	DSBC-125-250-PPSA-N3
	320	1804965	DSBC-125-320-PPVA-N3	1804671	DSBC-125-320-PPSA-N3
	400	1804966	DSBC-125-400-PPVA-N3	1804672	DSBC-125-400-PPSA-N3
	500	1804967	DSBC-125-500-PPVA-N3	1804673	DSBC-125-500-PPSA-N3
	1 ... 2,800	1755348	DSBC-125-...-PPVA-N3	1755619	DSBC-125-...-PPSA-N3

 Note

Other variants in the modular product system → 30

Standard cylinders DSBC, to ISO 15552

Ordering data – Modular products

Ordering table											
Size	32	40	50	63	80	100	125	Conditions	Code	Entry code	
M Module No.	1463250	1461995	1463770	1463475	1463495	1463520	1722457				
Function	Standard cylinder, double-acting, based on ISO 15552								DSBC	DSBC	
O Protection against rotation	None										
	With protection against rotation							-	1	-Q	
Running characteristics	Standard										
	Low friction							-	2	L	
	Constant, slow movement								2	M	
M Piston Ø [mm]	32	40	50	63	80	100	125		-...		
Stroke [mm]	1 ... 2,800									-...	
O Piston rod	At one end										
	Through piston rod									-T	
Piston rod thread type	Male thread										
	Female thread								3	F	
Profile type	Sensor slot on 1 side										
	Sensor slot on 3 sides									D3	
M Cushioning	Elastic cushioning rings/plates at both ends								4	-P	
	Pneumatic cushioning, self-adjusting at both ends								5	-PPS	
	Pneumatic cushioning, adjustable at both ends									-PPV	
↓ Position sensing	For proximity sensor									A	

- 1 Q Not with L, U, N3, T3, T4, P2, A1, A2, A3
Only up to stroke of 1500 mm
- 2 L, U Not with T, R3, T1, T3, T4, P2, A1, A2, A3, EX4
- 3 F Not with ...L
- 4 P Not with A1
- 5 PPS Not with T1, T3, T4, A1

Transfer order code

Standard cylinders DSBC, to ISO 15552

Ordering data – Modular product

Ordering table										
Size	32	40	50	63	80	100	125	Conditions	Code	Entry code
Standard	Based on ISO 15552									
	Corresponds to ISO 15552								-N3	
Corrosion protection	Standard									
	High corrosion protection							6	R3	
Temperature range	Standard									
	[°C]	Heat-resistant seals up to max. 120						7	T1	
	[°C]	-40 ... +80						7	T3	
	[°C]	0 ... +150						7	T4	
Particle protection	Standard									
	Bellows on bearing cap							-	8	P2
Wiper seal variant	None									
	Increased chemical resistance									A1
	Hard wiper seal									A2
	For unlubricated operation									A3
EU certification	None									
	[mm]	II 2GD						9	EX4	
Piston rod extension	None									
	[mm]	1 ... 500						10	-...E	
Piston rod thread extension	None									
	[mm]	1 ... 35		1 ... 70				10	-...L	

- 6** R3 Not with A2
- 7** T1, T3, T4 Not with P2, A1, A2, A3, EX4
- 8** P2 Not with N3, A1, A2, A3, EX4
Only for strokes 10 ... 500 mm
- 9** EX4 Not with T1, T3, T4, P2, A1, A3
- 10** ...E, ...L Only up to strokes of 2,000 mm

 - Note
The piston rod extension for the bellows is automatically taken into consideration when feature P2 is selected. This means that there is no need to specify a value for the feature ...E.

 - Note
When selecting the feature ...E in combination with feature P2, the part of the piston rod extension ...E is not covered by the bellows.

 - Note
When feature P2 is selected in combination with feature T (through piston rod), the bellows is mounted on one side only.

Transfer order code

- - -

Standard cylinders DSBC, standard hole pattern, with clamping unit

Ordering data – Modular product

Ordering table										
Size	32	40	50	63	80	100	125	Conditions	Code	Entry code
M Module No.	1463250	1461995	1463770	1463475	1463495	1463520	1722457			
Function	Standard cylinder, double-acting, based on ISO 15552								DSBC	DSBC
O Protection against rotation	None									
	With protection against rotation							-	1	-Q
M Piston Ø [mm]	32	40	50	63	80	100	125		-...	
Stroke [mm]	10 ... 2,000								-...	
O Clamping unit	Attached								-C	C
Piston rod type	At one end									
	Through piston rod								T	
Piston rod thread type	Male thread									
	Female thread							2	F	
Profile type	Sensor slot on 1 side									
	Sensor slot on 3 sides								D3	
M Cushioning	Elastic cushioning rings/plates at both ends								-P	
	Pneumatic cushioning, self-adjusting at both ends								-PPS	
	Pneumatic cushioning, adjustable at both ends								-PPV	
Position sensing,	For proximity sensor								A	A
Piston rod extension [mm]	None									
	1 ... 500								-...E	
Piston rod thread extension [mm]	None									
	1 ... 35		1 ... 70						-...L	

- 1 Q Only available with T
Only up to stroke 1,500 mm
- 2 F Not with ...L

Transfer order code

- - - -

 -

 - -

Standard cylinders DSBC, standard hole pattern, with end-position locking

Ordering data – Modular product

Ordering table									
Size	32	40	50	63	80	100	Conditions	Code	Entry code
[M] Module No.	1463250	1461995	1463770	1463475	1463495	1463520			
Function	Standard cylinder, double-acting, based on ISO 15552							DSBC	DSBC
Piston Ø [mm]	32	40	50	63	80	100		-...	
Stroke [mm]	10 ... 2,000							-...	
[O] End-position locking	None								
	At both ends							E1	
	With piston rod in advanced position							E2	
	With piston rod in retracted position							E3	
Piston rod thread type	Male thread								
	Female thread						[1]	F	
Profile type	Sensor slot on 1 side								
	Sensor slot on 3 sides							D3	
[M] Cushioning	Elastic cushioning rings/plates at both ends							-P	
	Pneumatic cushioning, adjustable at both ends							-PPV	
Position sensing	For proximity sensor							A	A
Piston rod extension [mm]	None								
	1 ... 500							-...E	
Piston rod thread extension [mm]	None								
	1 ... 35		1 ... 70					-...L	

[1] F Not with ...L

Transfer order code

-
 -

 -

 -
 -

Standard cylinders DSBC, to ISO 15552

Accessories



Foot mounting HNC/CRHNC

Materials:

HNC: Galvanised steel

CRHNC: High-alloy steel

Free of copper and PTFE

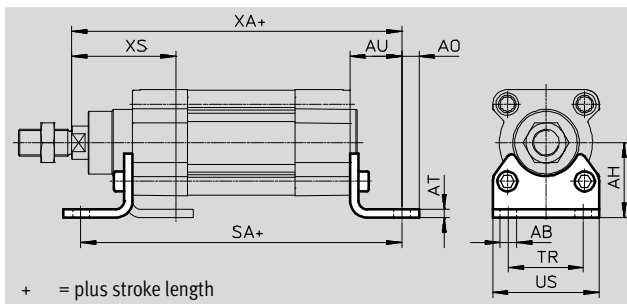

Dimensions and ordering data												
For Ø [mm]	AB Ø	AH	AO	AT	AU	SA		TR	US	XA		XS
						DSBC-...	DSBC-...-C			DSBC-...	DSBC-...-C	
32	7	32	6.5	4	24	142	187	32	45	143.1	188.1	46
40	10	36	9	4	28	161	214	36	54	161.9	214.9	52.7
50	10	45	9.5	5	32	170	237	45	64	173.8	240.8	62.6
63	10	50	12.5	5	32	185	261	50	75	189.1	265.1	62.9
80	12	63	15	6	41	210	305	63	93	214.6	309.6	80.4
100	14.5	71	17.5	6	41	220	318	75	110	228.5	326.7	84.3
125	16.5	90	22	8	45	250	375	90	131	270	394.3	102

For Ø [mm]	Basic design				High corrosion protection			
	CRC ¹⁾	Weight [g]	Part No.	Type ²⁾	CRC ¹⁾	Weight [g]	Part No.	Type ²⁾
32	2	144	174369	HNC-32	4	139	176937	CRHNC-32
40	2	193	174370	HNC-40	4	188	176938	CRHNC-40
50	2	353	174371	HNC-50	4	341	176939	CRHNC-50
63	2	436	174372	HNC-63	4	424	176940	CRHNC-63
80	2	829	174373	HNC-80	4	809	176941	CRHNC-80
100	2	1,009	174374	HNC-100	4	990	176942	CRHNC-100
125	2	1,902	174375	HNC-125	4	1,920	176943	CRHNC-125

- 1) Corrosion resistance class 2 according to Festo standard 940 070
 Components subject to moderate corrosion stress. Externally visible parts with primarily decorative surface requirements which are in direct contact with a normal industrial environment or media such as coolants or lubricating agents.
 Corrosion resistance class 4 according to Festo standard 940 070
 Components subject to very high corrosion stress. Parts used with aggressive media, e.g. in the food or chemical industry. These applications should be supported with special tests with the media if required.
- 2) ATEX-compliant

Standard cylinders DSBC, to ISO 15552

Accessories

Flange mounting FNC/CRFNG

Materials:

- FNC: Galvanised steel
- CRFNG: High-alloy steel
- Free of copper and PTFE
- RoHS-compliant

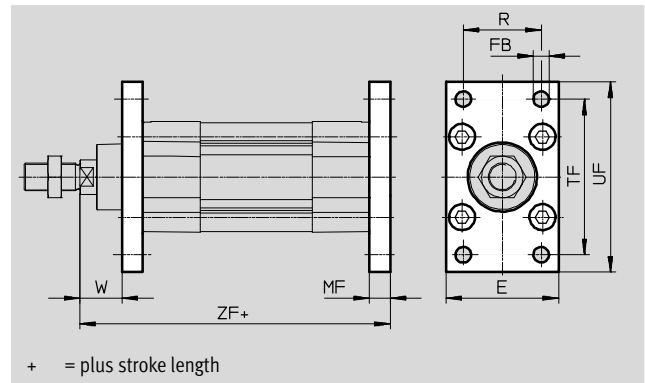

Dimensions and ordering data									
For Ø [mm]	E	FB Ø H13	MF	R	TF	UF	W	ZF	
								DSBC-...	DSBC-...-C
32	45	7	10	32	64	80	16	129.1	174.1
40	54	9	10	36	72	90	18.7	143.9	196.9
50	65	9	12	45	90	110	23.6	153.8	220.8
63	75	9	12	50	100	120	23.9	169.1	245.1
80	93	12	16	63	126	150	29.4	189.6	284.6
100	110	14	16	75	150	175	33.3	203.5	301.7
125	132	16	20	90	180	210	45	245	369.3

For Ø [mm]	Basic design				High corrosion protection			
	CRC ¹⁾	Weight [g]	Part No.	Type ²⁾	CRC ¹⁾	Weight [g]	Part No.	Type ²⁾
32	1	221	174376	FNC-32	4	225	161846	CRFNG-32
40	1	291	174377	FNC-40	4	300	161847	CRFNG-40
50	1	536	174378	FNC-50	4	540	161848	CRFNG-50
63	1	679	174379	FNC-63	4	680	161849	CRFNG-63
80	1	1,495	174380	FNC-80	4	1,500	161850	CRFNG-80
100	1	2,041	174381	FNC-100	4	2,100	161851	CRFNG-100
125	1	3,775	174382	FNC-125	4	3,780	185363	CRFNG-125

1) Corrosion resistance class 1 according to Festo standard 940 070
 Components subject to low corrosion stress. Transport and storage protection. Parts that do not have primarily decorative surface requirements, e.g. in internal areas that are not visible or behind covers.
 Corrosion resistance class 4 according to Festo standard 940 070
 Components subject to very high corrosion stress. Parts used with aggressive media, e.g. in the food or chemical industry. These applications should be supported with special tests with the media if required.

2) ATEX-compliant

Standard cylinders DSBC, to ISO 15552

Accessories

Trunnion flange ZNCF/CRZNG

Materials:

ZNCF: Stainless steel casting

CRZNG: Electropolished stainless steel casting

Free of copper and PTFE

RoHS-compliant

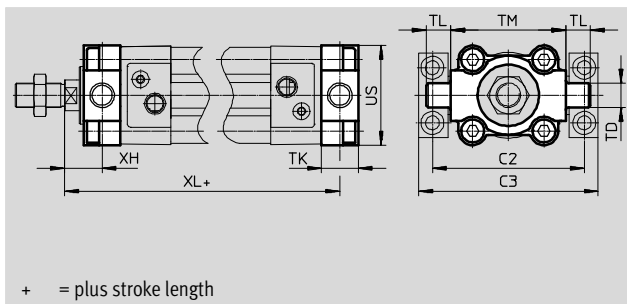

Dimensions and ordering data

For Ø [mm]	C2	C3	TD Ø e9	TK	TL	TM	US	XH	XL	
									DSBC-...	DSBC-...-C
32	71	86	12	16	12	50	45	18	127.1	172.1
40	87	105	16	20	16	63	54	18.7	143.9	196.9
50	99	117	16	24	16	75	64	23.6	153.8	220.8
63	116	136	20	24	20	90	75	23.9	169.1	245.1
80	136	156	20	28	20	110	93	31.4	187.6	282.6
100	164	189	25	38	25	132	110	30.3	206.5	304.7
125	192	217	25	50	25	160	131	40	250	374.3

For Ø [mm]	Basic design				High corrosion protection			
	CRC ¹⁾	Weight [g]	Part No.	Type ²⁾	CRC ¹⁾	Weight [g]	Part No.	Type ²⁾
32	2	150	174411	ZNCF-32	4	150	161852	CRZNG-32
40	2	285	174412	ZNCF-40	4	285	161853	CRZNG-40
50	2	473	174413	ZNCF-50	4	473	161854	CRZNG-50
63	2	687	174414	ZNCF-63	4	687	161855	CRZNG-63
80	2	1,296	174415	ZNCF-80	4	1,296	161856	CRZNG-80
100	2	2,254	174416	ZNCF-100	4	2,254	161857	CRZNG-100
125	2	3,484	174417	ZNCF-125	4	3,484	185362	CRZNG-125

- Corrosion resistance class 2 according to Festo standard 940 070
Components subject to moderate corrosion stress. Externally visible parts with primarily decorative surface requirements which are in direct contact with a normal industrial environment or media such as coolants or lubricating agents.
Corrosion resistance class 4 according to Festo standard 940 070
Components subject to very high corrosion stress. Parts used with aggressive media, e.g. in the food or chemical industry. These applications should be supported with special tests with the media if required.
- ATEX-compliant

Standard cylinders DSBC, to ISO 15552

Accessories

Trunnion support LNZG

Materials:

Trunnion support: Anodised aluminium

Plain bearing: Plastic

Free of copper and PTFE

RoHS-compliant

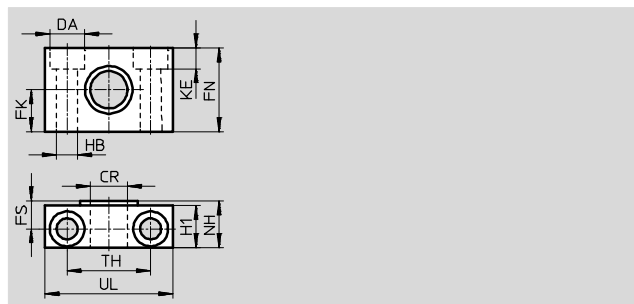
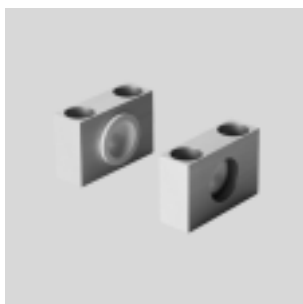

Dimensions and ordering data														Weight [g]	Part No.	Type
For \varnothing [mm]	CR \varnothing D11	DA \varnothing H13	FK \varnothing ± 0.1	FN	FS	H1	HB \varnothing H13	KE	NH	TH ± 0.2	UL	CRC ¹⁾				
32	12	11	15	30	10.5	15	6.6	6.8	18	32	46	2	83	32959	LNZG-32	
40, 50	16	15	18	36	12	18	9	9	21	36	55	2	129	32960	LNZG-40/50	
63, 80	20	18	20	40	13	20	11	11	23	42	65	2	178	32961	LNZG-63/80	
100, 125	25	20	25	50	16	24.5	14	13	28.5	50	75	2	306	32962	LNZG-100/125	

1) Corrosion resistance class 2 according to Festo standard 940 070
 Components subject to moderate corrosion stress. Externally visible parts with primarily decorative surface requirements which are in direct contact with a normal industrial environment or media such as coolants or lubricating agents.

Trunnion support CRLNZG

Materials:

High-alloy steel

Free of copper and PTFE

RoHS-compliant

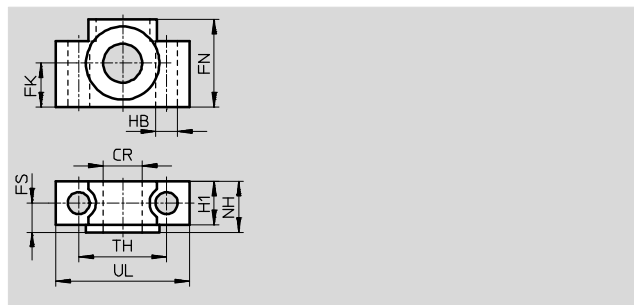
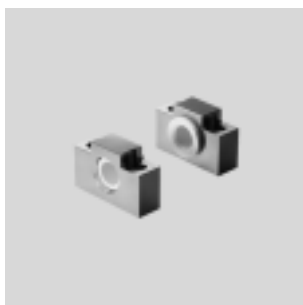

Dimensions and ordering data												Weight [g]	Part No.	Type
For \varnothing [mm]	CR \varnothing D11	FK \varnothing ± 0.1	FN	FS	H1	HB \varnothing H13	NH	TH ± 0.2	UL	CRC ¹⁾				
32	12	15	30	10.5	15	6.6	18	32	46	4	205	161874	CRLNZG-32	
40, 50	16	18	36	12	18	9	21	36	55	4	323	161875	CRLNZG-40/50	
63, 80	20	20	40	13	20	11	23	42	65	4	435	161876	CRLNZG-63/80	
100, 125	25	25	50	16	24.5	14	28.5	50	75	4	739	161877	CRLNZG-100/125	

1) Corrosion resistance class 4 to Festo standard 940 070
 Components subject to high corrosion stress. Parts used with aggressive media, e.g. in the food or chemical industry. These applications should be supported with special tests with the media if required.

Standard cylinders DSBC, to ISO 15552

Accessories

Swivel flange SNC

Materials:
Die-cast aluminium
RoHS-compliant

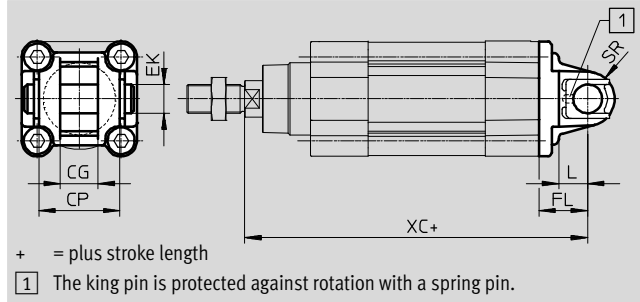

Dimensions and ordering data												
For Ø	CG	CP	EK	FL	L	SR	XC		CRC ¹⁾	Weight	Part No.	Type ²⁾
[mm]	H14	h14	Ø H9	±0.2			DSBC-...	DSBC-...-C		[g]		
32	14	34	10	22	13	10	141.1	186.1	2	90	174383	SNC-32
40	16	40	12	25	16	12	158.9	211.9	2	120	174384	SNC-40
50	21	45	16	27	16	12	168.8	235.8	2	240	174385	SNC-50
63	21	51	16	32	21	16	189.1	265.1	2	320	174386	SNC-63
80	25	65	20	36	22	16	209.6	304.6	2	625	174387	SNC-80
100	25	75	20	41	27	20	228.5	326.7	2	830	174388	SNC-100
125	37	97	30	50	30	25	275	399.3	2	1 785	174389	SNC-125

1) Corrosion resistance class 2 according to Festo standard 940 070
Components subject to moderate corrosion stress. Externally visible parts with primarily decorative surface requirements which are in direct contact with a normal industrial environment or media such as coolants or lubricating agents.

2) ATEX-compliant

Standard cylinders DSBC, to ISO 15552

Accessories

Swivel flange SNCB/SNCB-...-R3

Materials:
 SNCB: Die-cast aluminium
 SNCB-...-R3: Die-cast aluminium with protective coating, high corrosion protection
 Free of copper and PTFE
 RoHS-compliant

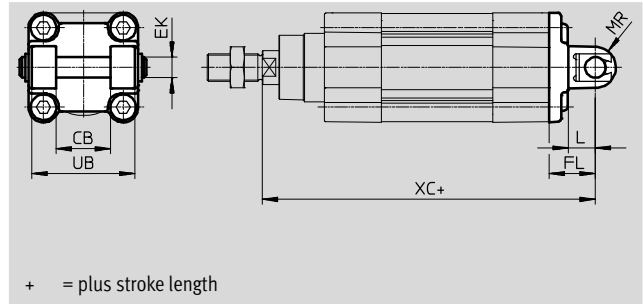

Dimensions and ordering data								
For Ø	CB	EK	FL	L	MR	UB	XC	
[mm]	H14	Ø e8	±0.2			h14	DSBC-...	DSBC-...-C
32	26	10	22	13	8.5	45	141.1	186.1
40	28	12	25	16	12	52	158.9	211.9
50	32	12	27	16	12	60	168.8	235.8
63	40	16	32	21	16	70	189.1	265.1
80	50	16	36	22	16	90	209.6	304.6
100	60	20	41	27	20	110	228.5	326.7
125	70	25	50	30	25	130	275	399.3

For Ø [mm]	Basic design				Variant R3 – High corrosion protection			
	CRC ¹⁾	Weight [g]	Part No.	Type	CRC ¹⁾	Weight [g]	Part No.	Type
32	2	103	174390	SNCB-32	3	100	176944	SNCB-32-R3
40	2	155	174391	SNCB-40	3	151	176945	SNCB-40-R3
50	2	232	174392	SNCB-50	3	228	176946	SNCB-50-R3
63	2	375	174393	SNCB-63	3	371	176947	SNCB-63-R3
80	2	636	174394	SNCB-80	3	632	176948	SNCB-80-R3
100	2	1,035	174395	SNCB-100	3	986	176949	SNCB-100-R3
125	2	1,860	174396	SNCB-125	3	1,776	176950	SNCB-125-R3

1) Corrosion resistance class 2 according to Festo standard 940 070
 Components subject to moderate corrosion stress. Externally visible parts with primarily decorative surface requirements which are in direct contact with a normal industrial environment or media such as coolants or lubricating agents.
 Corrosion resistance class 3 to Festo standard 940 070
 Components subject to high corrosion stress. Externally visible parts with primarily functional surface requirements which are in direct contact with a normal industrial environment or media such as solvents and cleaning agents.

Standard cylinders DSBC, to ISO 15552

Accessories

Swivel flange SNCS

Materials:

SNCS 32 ... 80:

Die-cast aluminium

SNCS 100 ... 125:

Wrought aluminium alloy

Free of copper and PTFE

RoHS-compliant

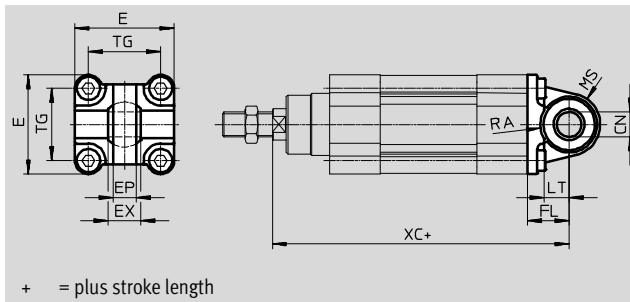
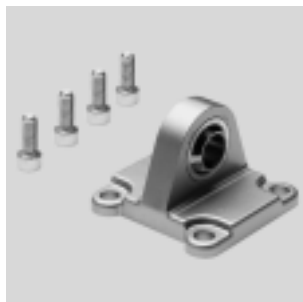

Dimensions and ordering data									
For Ø	CN	E	EP	EX	FL	LT	MS	RA	TG
[mm]	Ø		±0.2		±0.2			+1	
32	10 ^{+0.013}	45 ^{+0.2/-0.5}	10.5	14	22	13	15 ^{+0.5}	14.5	32.5
40	12 ^{+0.015}	54 ^{-0.5}	12	16	25	16	17 ^{+0.5}	17.5	38
50	16 ^{+0.015}	64 ^{-0.6}	15	21	27	16	20 ^{+0.5}	18.5	46.5
63	16 ^{+0.015}	75 ^{-0.6}	15	21	32	21	23 ^{-0.5}	23	56.5
80	20 ^{+0.018}	93 ^{-0.8}	18	25	36	22	28 ^{-0.5}	25	72
100	20 ^{+0.018}	109 ^{+1/-0.7}	18	25	41	27	30 ^{±0.5}	95	89
125	30 ^{+0.018}	132 ^{+1/-0.7}	25	37	50	30	39 ^{+0.5}	100	110

For Ø [mm]	XC		CRC ¹⁾	Weight [g]	Part No.	Type
	DSBC-...	DSBC-...-C				
32	141.1	186.1	2	86	174397	SNCS-32
40	158.9	211.9	2	122	174398	SNCS-40
50	168.8	235.8	2	216	174399	SNCS-50
63	189.1	265.1	2	281	174400	SNCS-63
80	209.6	304.6	2	557	174401	SNCS-80
100	228.5	326.7	2	690	174402	SNCS-100
125	275	399.3	2	1,375	174403	SNCS-125

1) Corrosion resistance class 2 according to Festo standard 940 070

Components subject to moderate corrosion stress. Externally visible parts with primarily decorative surface requirements which are in direct contact with a normal industrial environment or media such as coolants or lubricating agents.

Standard cylinders DSBC, to ISO 15552

Accessories

Swivel flange SNCL

Materials:

Die-cast aluminium

Free of copper and PTFE

RoHS-compliant

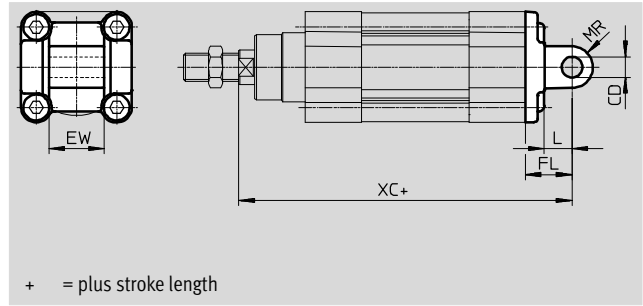

Dimensions and ordering data											
For \varnothing [mm]	CD \varnothing H9	EW h12	FL ± 0.2	L	MR	XC		CRC ¹⁾	Weight [g]	Part No.	Type
						DSBC-...	DSBC-...-C				
32	10	26	22	13	10	141.1	186.1	2	75	174404	SNCL-32
40	12	28	25	16	12	158.9	211.9	2	100	174405	SNCL-40
50	12	32	27	16	12	168.8	235.8	2	160	174406	SNCL-50
63	16	40	32	21	16	189.1	265.1	2	250	174407	SNCL-63
80	16	50	36	22	16	209.6	304.6	2	405	174408	SNCL-80
100	20	60	41	27	20	228.5	326.7	2	655	174409	SNCL-100
125	25	70	50	30	25	275	399.3	2	1,245	174410	SNCL-125

1) Corrosion resistance class 2 according to Festo standard 940 070
 Components subject to moderate corrosion stress. Externally visible parts with primarily decorative surface requirements which are in direct contact with a normal industrial environment or media such as coolants or lubricating agents.

Standard cylinders DSBC, to ISO 15552

Accessories

Trunnion mounting kit DAMT

The mounting kit can be attached at any position along the profile barrel of the cylinder.

Material:
Galvanised steel
RoHS-compliant

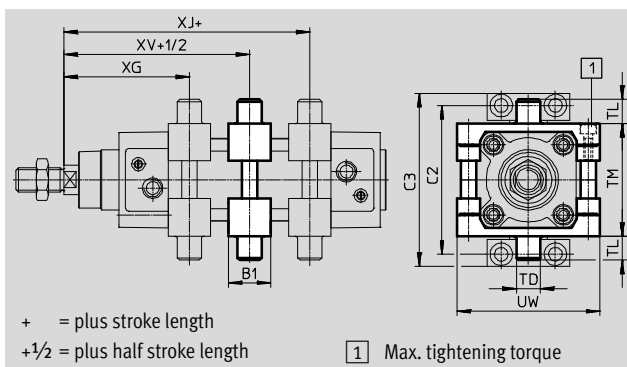



Dimensions and ordering data							
For Ø	B1	C2	C3	TD	TL	TM	UW
[mm]				Ø e9			
32	30	71	86	12	12	50	65
40	32	87	105	16	16	63	75
50	34	99	117	16	16	75	95
63	41	116	136	20	20	90	105
80	44	136	156	20	20	110	130
100	48	164	189	25	25	132	145
125	50	192	217	25	25	160	177

For Ø	XG	XJ	XV	Max. tightening torque	CRC ¹⁾	Weight	Part No.	Type ²⁾
[mm]	min.	max.		[Nm]		[g]		
32	69±1,4	76±1,4	73±1,4	4+1	1	213	2213233	DAMT-V1-32-A
40	77.7±1,4	84.9±1,4	81.2±1,4	8+1	1	388	2214899	DAMT-V1-40-A
50	85.6±1,4	91.8±1,4	88.6±1,4	8+2	1	608	2214909	DAMT-V1-50-A
63	96.9±1,8	96.1±1,8	96.4±1,8	18+2	1	911	2214971	DAMT-V1-63-A
80	110.4±1,8	108.6±1,8	109.4±1,8	28+2	1	1,494	163529	DAMT-V1-80-A
100	121.3±1,8	115.5±1,8	118.3±1,8	28+2	1	2,095	163530	DAMT-V1-100-A
125	134.7±1,8	155.3±1,8	145±1,8	40+2	1	3,548	1812524	DAMT-V8-125-A

1) Corrosion resistance class 1 according to Festo standard 940 070
Components subject to low corrosion stress. Transport and storage protection. Parts that do not have primary decorative surface requirements, e.g. in internal areas that are not visible or behind covers.
2) ATEX-compliant

Standard cylinders DSBC, to ISO 15552

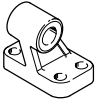
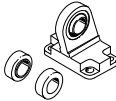
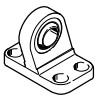
Accessories

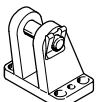
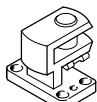



Ordering data – Mounting attachments				Technical data → Internet: clevis foot			
Name	For Ø	Part No.	Type	Name	For Ø	Part No.	Type
Clevis foot LNG				Clevis foot LSN			
	32	33890	LNG-32		32	5561	LSN-32
	40	33891	LNG-40		40	5562	LSN-40
	50	33892	LNG-50		50	5563	LSN-50
	63	33893	LNG-63		63	5564	LSN-63
	80	33894	LNG-80		80	5565	LSN-80
	100	33895	LNG-100		100	5566	LSN-100
	125	33896	LNG-125		125	6987	LSN-125
Clevis foot LSNG				Clevis foot LSNSG			
	32	31740	LSNG-32		32	31747	LSNSG-32
	40	31741	LSNG-40		40	31748	LSNSG-40
	50	31742	LSNG-50		50	31749	LSNSG-50
	63	31743	LSNG-63		63	31750	LSNSG-63
	80	31744	LSNG-80		80	31751	LSNSG-80
	100	31745	LSNG-100		100	31752	LSNSG-100
	125	31746	LSNG-125		125	31753	LSNSG-125
Clevis foot LBG¹⁾				Right-angle clevis foot LQG¹⁾			
	32	31761	LBG-32		32	31768	LQG-32
	40	31762	LBG-40		40	31769	LQG-40
	50	31763	LBG-50		50	31770	LQG-50
	63	31764	LBG-63		63	31771	LQG-63
	80	31765	LBG-80		80	31772	LQG-80
	100	31766	LBG-100		100	31773	LQG-100
	125	31767	LBG-125		125	31774	LQG-125

1) ATEX-compliant



Ordering data – Mounting components, corrosion-resistant			Technical data → Internet: crlng	
Name	For Ø	Part No.	Type	
Clevis foot CRLNG				
	32	161840	CRLNG-32	
	40	161841	CRLNG-40	
	50	161842	CRLNG-50	
	63	161843	CRLNG-63	
	80	161844	CRLNG-80	
	100	161845	CRLNG-100	
	125	176951	CRLNG-125	

Standard cylinders DSBC, to ISO 15552

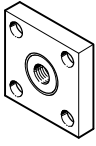
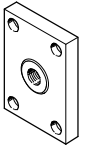
Accessories

Ordering data – Piston rod attachments				Technical data → Internet: piston rod attachment			
Name	For Ø	Part No.	Type	Name	For Ø	Part No.	Type
Rod eye SGS				Rod clevis SGA¹⁾			
	32	9261	SGS-M10x1,25		32	32954	SGA-M10x1,25
	40	9262	SGS-M12x1,25		40	10767	SGA-M12x1,25
	50	9263	SGS-M16x1,5		50	10768	SGA-M16x1,5
	63						
	80	9264	SGS-M20x1,5		80	10769	SGA-M20x1,5
	100	10774	SGS-M27x2		100	10770	SGA-M27x2
	125						
Rod clevis SG¹⁾				Self-aligning rod coupler FK¹⁾			
	32	6144	SG-M10x1,25		32	6140	FK-M10x1,25
	40	6145	SG-M12x1,25		40	6141	FK-M12x1,25
	50	6146	SG-M16x1,5		50	6142	FK-M16x1,5
	63						
	80	6147	SG-M20x1,5	80	6143	FK-M20x1,5	
	100	14987	SG-M27x2-B	100	10485	FK-M27x2	
	125						
Coupling piece KSG¹⁾				Coupling piece KSZ¹⁾			
	32	32963	KSG-M10x1,25		32	36125	KSZ-M10x1,25
	40	32964	KSG-M12x1,25		40	36126	KSZ-M12x1,25
	50	32965	KSG-M16x1,5		50	36127	KSZ-M16x1,5
	63						
	80	32966	KSG-M20x1,5		80	36128	KSZ-M20x1,5
	100	32967	KSG-M27x2		100	-	-
	125						

1) ATEX-compliant

Ordering data – Piston rod attachments, corrosion-resistant				Technical data → Internet: crsg			
Name	For Ø	Part No.	Type	Name	For Ø	Part No.	Type
Rod eye CRSGS				Rod clevis CRSG¹⁾			
	32	195582	CRSGS-M10x1,25		32	13569	CRSG-M10x1,25
	40	195583	CRSGS-M12x1,25		40	13570	CRSG-M12x1,25
	50	195584	CRSGS-M16x1,5		50	13571	CRSG-M16x1,5
	63						
	80	195585	CRSGS-M20x1,5		80	13572	CRSG-M20x1,5
	100	195586	CRSGS-M27x2		100	185361	CRSG-M27x2
	125						
Self-aligning rod coupler CRFK							
	32	2305778	CRFK-M10x1,25				
	40	2305779	CRFK-M12x1,25				
	50	2490673	CRFK-M16x1,5				
	63						
	80	2545677	CRFK-M20x1,5				
	100						

1) ATEX-compliant

Standard cylinders DSBC, to ISO 15552

Accessories

Protective bellows kit DADB



General technical data						
Type DADB-V6-	32	40	50	63	80	100
Max. stroke range of cylinder ¹⁾	[mm]	10 ... 500	10 ... 500	10 ... 500	10 ... 500	10 ... 500
Type of mounting	Via threaded pin					
Mounting position	Any					
Resistance to media	Dust, chippings, oil, grease, fuel (→ Internet: Resistance to media)					
Ambient temperature ²⁾	[°C]	-10 ... +80				
Protection class	IP54					
Corrosion resistance class CRC ³⁾	3					

1) In combination with protective bellows kit DADB

2) Note operating range of proximity sensors and cylinder

3) Corrosion resistance class 3 according to Festo standard 940 070

Components subject to high corrosion stress. Externally visible parts with primarily functional surface requirements which are in direct contact with a normal industrial environment or media such as solvents and cleaning agents.

Materials

Sectional view

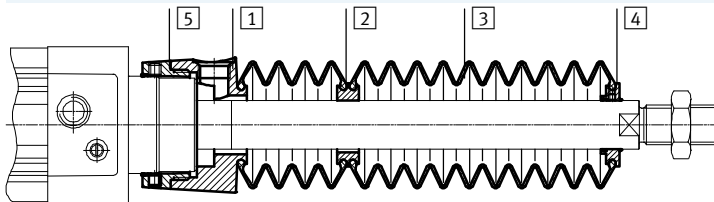

Bellows		
1	Connection	Polyamide
2	Adapter	Polyamide
3	Bellows	Nitrile rubber
4	End piece	Polyamide
5	Connector	Polyamide
-	O-ring	Nitrile rubber
Note on materials		Free of copper and PTFE
		Conforms to RoHS

Weight [g]						
Type DADB-V6- Stroke [mm]	32	40	50	63	80	100
10 ... 50	29	42	71	69	99	124
51 ... 125	41	56	91	89	127	152
126 ... 175	52	68	105	103	140	165
176 ... 250	66	85	129	127	193	218
251 ... 300	79	100	147	145	231	255
301 ... 350	92	115	166	164	268	293
351 ... 375	92	115	167	165	259	284
376 ... 425	104	129	185	183	296	321
426 ... 475	117	144	204	202	334	359
476 ... 500	117	144	205	203	324	349

Standard cylinders DSBC, to ISO 15552

Accessories

Travel speed v as a function of tubing length l

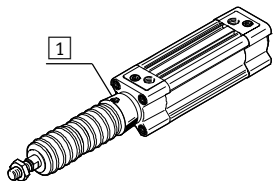

The bellows kit is a leak-free system. To prevent unwanted media from being drawn in, the supply and exhaust air must be ducted via a pressure compensation hole in the connection

part **1**. The pressure generated in the protective bellows kit by the positioning motion is primarily defined by the travel

speed and tubing length. The recommended tubing length based on the travel speed of the drive can be read from the graph.

Advance

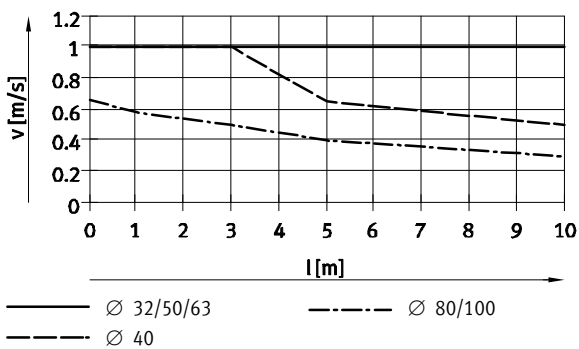

Return

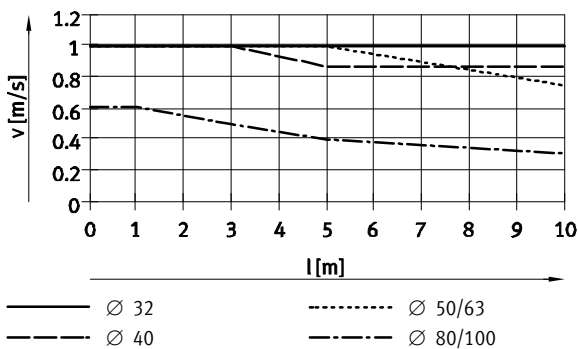

Note
The push-in fittings opposite must be used for the pressure compensation hole.
Silencers can be used as an alternative. This reduces the travel speed slightly.

Tube length and push-in fitting for pressure compensation hole			
Ø [mm]	Tubing O.D. [mm]	Push-in fitting	
		Part No.	Type
32, 40	8	186109	QS-G ¹ / ₈ -8-I
		578376	NPQH-DK-G18-Q8-P10
		578362	NPQH-D-G18-S8-P10
50, 63, 80, 100	12	186350	QS-G ¹ / ₄ -12
		578344	NPQH-D-G14-Q12-P10
		578366	NPQH-D-G14-S12-P10

Standard cylinders DSBC, to ISO 15552

Accessories

Dimensions Download CAD data → www.festo.com

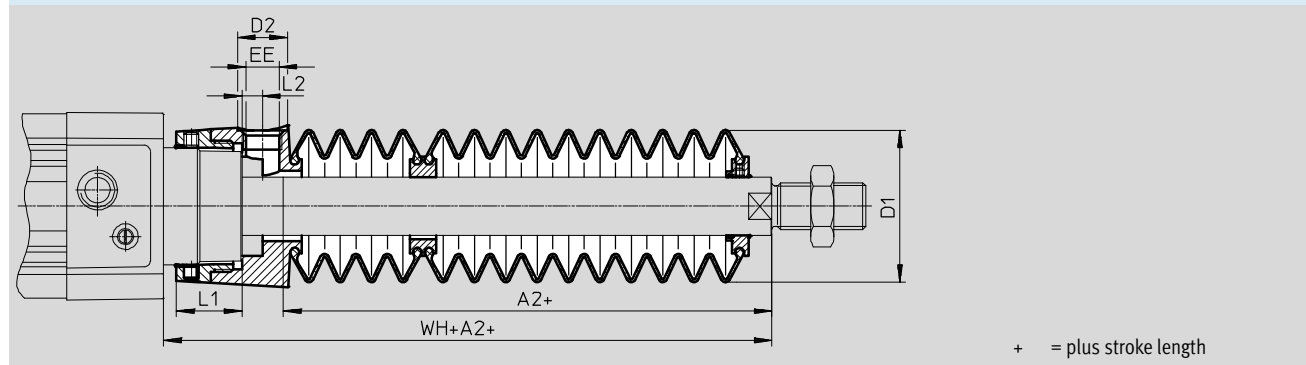

Ø Stroke [mm]	32							40						
	A2 ¹⁾	D1 max.	D2	EE	L1	L2	WH+A2	A2 ¹⁾	D1 max.	D2	EE	L1	L2	WH+A2
10 ... 50	29	38	14	G1/8	12.9	5.4	55	28	46	14	G1/8	16.3	5.4	56.7
51 ... 125	47						73	43						71.7
126 ... 175	61						87	56						84.7
176 ... 250	80						106	72						100.7
251 ... 300	96						122	86						114.7
301 ... 350	112						138	100						128.7
351 ... 375	114						140	101						129.7
376 ... 425	130						156	115						143.7
426 ... 475	145						171	130						158.7
476 ... 500	147						173	131						159.7

Ø Stroke [mm]	50							63						
	A2 ¹⁾	D1 max.	D2	EE	L1	L2	WH+A2	A2 ¹⁾	D1 max.	D2	EE	L1	L2	WH+A2
10 ... 50	28	57	17	G1/4	22.35	7	63.6	28	57	17	G1/4	22.4	7	63.9
51 ... 125	46						81.6	46						81.9
126 ... 175	56						91.6	56						91.9
176 ... 250	73						108.6	73						108.9
251 ... 300	86						121.6	86						121.9
301 ... 350	97						132.6	97						132.9
351 ... 375	105						140.6	105						140.9
376 ... 425	116						151.6	116						151.9
426 ... 475	126						161.6	126						161.9
476 ... 500	134						169.6	134						169.9

Ø Stroke [mm]	80							100						
	A2 ¹⁾	D1 max.	D2	EE	L1	L2	WH+A2	A2 ¹⁾	D1 max.	D2	EE	L1	L2	WH+A2
10 ... 50	25	93	17	G1/4	28	4	70.4	25	93	17	G1/4	28	4	74.3
51 ... 125	37						82.4	37						86.3
126 ... 175	49						94.4	49						98.3
176 ... 250	62						107.4	62						111.3
251 ... 300	74						119.4	74						123.3
301 ... 350	86						131.4	86						135.3
351 ... 375	87						132.4	87						136.3
376 ... 425	98						143.4	98						147.3
426 ... 475	110						155.4	110						159.3
476 ... 500	111						156.4	111						160.3

1) The dimension corresponds to the E value (piston rod extension) of the drive

Standard cylinders DSBC, to ISO 15552

Accessories

Ordering data – Protective bellows kit

An extended piston rod (order code E) is required when using a protective bellows kit → Ordering data – Modular products.

The necessary dimension for order code E as a function of piston diameter and cylinder stroke as well as the corresponding protective bellows kit is indicated in the table below:

Order example:

Selected standard cylinder:

DSBC-32-320-PPV-A-...

The dimension for the corresponding E value (see table):
112 mm

Complete type code for standard cylinder:

DSBC-32-320-PPV-A-...-112E

The corresponding protective bellows kit:

DADB-V6-32-S301-350

Cylinder data			Protective bellows kit		Cylinder data			Protective bellows kit	
∅	Stroke	Dimension for E	Part No.	Type	∅	Stroke	Dimension for E	Part No.	Type
[mm]	[mm]	[mm]			[mm]	[mm]	[mm]		
32	10 ... 50	29	553271	DADB-V6-32-S10-50	40	10 ... 50	28	553291	DADB-V6-40-S10-50
	51 ... 125	47	553273	DADB-V6-32-S51-125		51 ... 125	43	553293	DADB-V6-40-S51-125
	126 ... 175	61	553275	DADB-V6-32-S126-175		126 ... 175	56	553295	DADB-V6-40-S126-175
	176 ... 250	80	553277	DADB-V6-32-S176-250		176 ... 250	72	553297	DADB-V6-40-S176-250
	251 ... 300	96	553279	DADB-V6-32-S251-300		251 ... 300	86	553399	DADB-V6-40-S251-300
	301 ... 350	112	553281	DADB-V6-32-S301-350		301 ... 350	100	553301	DADB-V6-40-S301-350
	351 ... 375	114	553283	DADB-V6-32-S351-375		351 ... 375	101	553303	DADB-V6-40-S351-375
	376 ... 425	130	553285	DADB-V6-32-S376-425		376 ... 425	115	553305	DADB-V6-40-S376-425
	426 ... 475	145	553287	DADB-V6-32-S426-475		426 ... 475	130	553307	DADB-V6-40-S426-475
	476 ... 500	147	553289	DADB-V6-32-S476-500		476 ... 500	131	553309	DADB-V6-40-S476-500
50	10 ... 50	28	553311	DADB-V6-50-S10-50	63	10 ... 50	28	553331	DADB-V6-63-S10-50
	51 ... 125	46	553313	DADB-V6-50-S51-125		51 ... 125	46	553333	DADB-V6-63-S51-125
	126 ... 175	56	553315	DADB-V6-50-S126-175		126 ... 175	56	553335	DADB-V6-63-S126-175
	176 ... 250	73	553317	DADB-V6-50-S176-250		176 ... 250	73	553337	DADB-V6-63-S176-250
	251 ... 300	86	553319	DADB-V6-50-S251-300		251 ... 300	86	553339	DADB-V6-63-S251-300
	301 ... 350	97	553321	DADB-V6-50-S301-350		301 ... 350	97	553341	DADB-V6-63-S301-350
	351 ... 375	105	553323	DADB-V6-50-S351-375		351 ... 375	105	553343	DADB-V6-63-S351-375
	376 ... 425	116	553325	DADB-V6-50-S376-425		376 ... 425	116	553345	DADB-V6-63-S376-425
	426 ... 475	126	553327	DADB-V6-50-S426-475		426 ... 475	126	553347	DADB-V6-63-S426-475
476 ... 500	134	553329	DADB-V6-50-S476-500	476 ... 500	134	553349	DADB-V6-63-S476-500		
80	10 ... 50	25	553351	DADB-V6-80-S10-50	100	10 ... 50	25	553371	DADB-V6-100-S10-50
	51 ... 125	37	553353	DADB-V6-80-S51-125		51 ... 125	37	553373	DADB-V6-100-S51-125
	126 ... 175	49	553355	DADB-V6-80-S126-175		126 ... 175	49	553375	DADB-V6-100-S126-175
	176 ... 250	62	553357	DADB-V6-80-S176-250		176 ... 250	62	553377	DADB-V6-100-S176-250
	251 ... 300	74	553359	DADB-V6-80-S251-300		251 ... 300	74	553379	DADB-V6-100-S251-300
	301 ... 350	86	553361	DADB-V6-80-S301-350		301 ... 350	86	553381	DADB-V6-100-S301-350
	351 ... 375	87	553363	DADB-V6-80-S351-375		351 ... 375	87	553383	DADB-V6-100-S351-375
	376 ... 425	98	553365	DADB-V6-80-S376-425		376 ... 425	98	553385	DADB-V6-100-S376-425
	426 ... 475	110	553367	DADB-V6-80-S426-475		426 ... 475	110	553387	DADB-V6-100-S426-475
476 ... 500	111	553369	DADB-V6-80-S476-500	476 ... 500	111	553389	DADB-V6-100-S476-500		

Standard cylinders DSBC, to ISO 15552

Accessories

Multi-position kit DPNC

Material:

- Flange: Wrought aluminium alloy
- Threaded pins, hex nuts: Galvanised steel

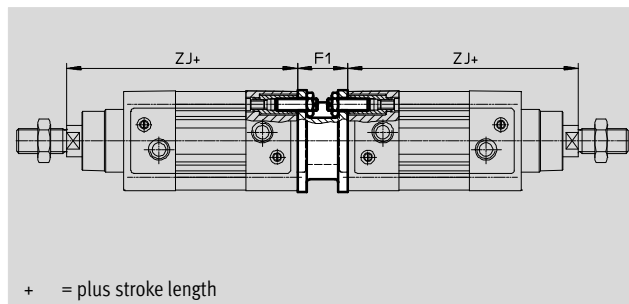
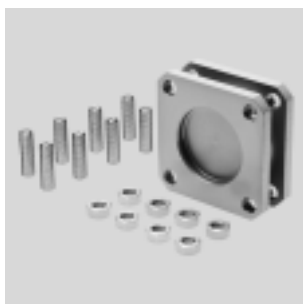

Dimensions and ordering data

For Ø [mm]	F1	ZJ		Max. overall stroke length [mm]	Weight [g]	Part No.	Type ¹⁾
		DSBC-... +1.8	DSBC-...-C				
32	27	119.1	164.1	500	85	174418	DPNC-32
40	27	133.9	186.9	800	115	174419	DPNC-40
50	32	141.8	208.8	800	210	174420	DPNC-50
63	28	157.1	233.1	700	360	174421	DPNC-63
80	38	173.6	268.6	1,000	620	174422	DPNC-80
100	38	187.5	285.7	900	1,190	174423	DPNC-100
125	48	225	349.3	1,000	1,600	174424	DPNC-125

 Note
The maximum overall stroke length must not be exceeded when combining cylinders and multi-position kits.

1) ATEX-compliant

Connecting two cylinders with identical piston Ø as a 3 or 4-position cylinder

A 3 or 4-position cylinder consists of two separate cylinders whose piston rods advance in opposing directions.

This means that depending on actuation and stroke division, this type of cylinder can assume up to four positions.

In each case the cylinder is driven precisely against a stop. Note that when one end of the piston rod is

fixed, the cylinder barrel executes the movement. The cylinder's connections must be flexible.

To achieve 3 positions

Two cylinders with identical stroke length must be connected together.

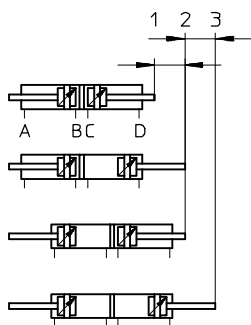

To achieve 4 positions

Two cylinders with different stroke lengths must be connected together.

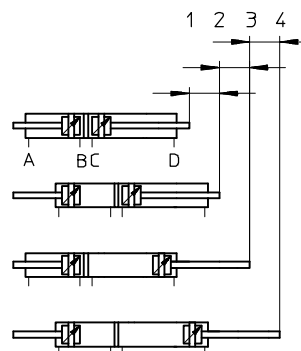

Standard cylinders DSBC, to ISO 15552

Accessories

Mounting kit DAVM

For lateral valve assembly, directly on the drive

Materials:
 Mounting bracket, screws: Galvanised steel
 Slot nut: High-alloy stainless steel

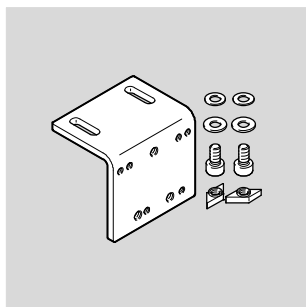

Example:

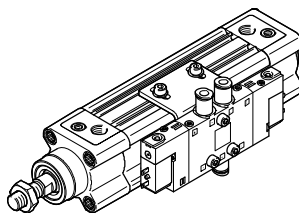

The hole pattern on the angle bracket enables solenoid valves to be attached on the right according to the assignment. The following table includes a few solenoid valves that are available.

Allocation table, mounting kit for solenoid valves		
Mounting kit	Solenoid valve	
DAVM-MV-V1-32-V	CPE14	VUVG-L14
DAVM-MV-V1-50-V	CPE18, CPE24	VUVG-L18



Recommended solenoid valves CPE						Technical data → Internet: cpe
	For Ø [mm]	Mounting screw	Pneumatic connection	Function	Part No.	Type
	Single solenoid					
	32, 40	M4x20	G1/8	5/2-way valve	196941	CPE14-M1BH-5L-1/8
	50, 63	M4x25	G1/4		163142	CPE18-M1H-5L-1/4
	80, 100, 125	M5x30	G3/8		163166	CPE24-M1H-5L-3/8
	Double solenoid					
	32, 40	M4x20	G1/8	5/2-way valve	196939	CPE14-M1BH-5J-1/8
50, 63	M4x25	G1/4	163143		CPE18-M1H-5J-1/4	
80, 100, 125	M5x30	G3/8	163167		CPE24-M1H-5J-3/8	

Accessories for solenoid valves CPE			
	For valve		Part No. Type
Plug socket with cable KMYZ/KMEB			
	CPE14	24 V DC, with PUR cable, 2.5 m	193687 KMYZ-9-24-2,5-LED-PUR-B
		24 V DC, with PUR cable, 5 m	193689 KMYZ-9-24-5-LED-PUR-B
	CPE18 CPE24	24 V DC, with PVC cable, 2.5 m, LED	151688 KMEB-1-24-2,5-LED
		24 V DC, with PVC cable, 5 m, LED	151689 KMEB-1-24-5-LED
		24 V DC, with PVC cable, 10 m, LED	193457 KMEB-1-24-10-LED

Standard cylinders DSBC, to ISO 15552

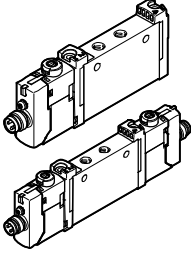
Accessories

Recommended solenoid valves VUVG						Technical data → Internet: vuvg
	For Ø [mm]	Mounting screw	Pneumatic connection	Function	Part No.	Type
	Single solenoid					
	32, 40	M3x20	G $\frac{1}{8}$	5/2-way valve	8031508	VUVG-L14-M52-MT-G18-1R8L
	50, 63	M4x25	G $\frac{1}{4}$		8031532	VUVG-L18-M52-MT-G14-1R8L
	Double solenoid					
	32, 40	M3x20	G $\frac{1}{8}$	5/2-way valve	574230	VUVG-L14-B52-T-G18-1R8L
	50, 63	M4x25	G $\frac{1}{4}$		8031533	VUVG-L18-B52-T-G14-1R8L

Accessories for solenoid valves VUVG					
	For valve	Electrical connection	Cable length	Part No.	Type
Connecting cable NEBU					
Technical data → Internet: nebu					
	VUVG-L14	Straight socket, M8x1, 3-pin	2.5 m	541333	NEBU-M8G3-K-2.5-LE3
	VUVG-L18		5 m	541334	NEBU-M8G3-K-5-LE3
		Angled socket, M8x1, 3-pin	2.5 m	541338	NEBU-M8W3-K-2.5-LE3
			5 m	541341	NEBU-M8W3-K-5-LE3

 Note

Dimensions and ordering data → 52

Standard cylinders DSBC, to ISO 15552

Accessories

Dimensions and ordering data

Download CAD data → www.festo.com

DAVM-MW-V1-32-V

DAVM-MW-V1-50-V

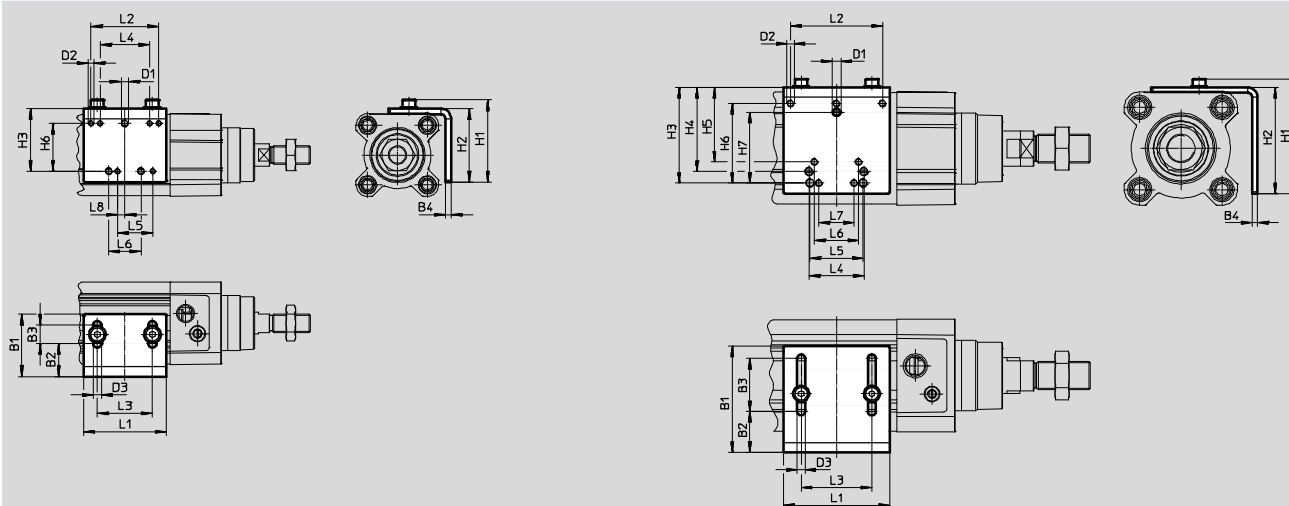

Note

Mounting is only possible on the side on which the pneumatic connections are located

Two slot nuts are included in the scope of delivery of the mounting kit. Other slot nuts → 139

For Ø [mm]	B1	B2	B3	B4	D1	D2	D3 Ø	H1	H2	H3	H4	H5	H6	H7
32	34	18	10	3	M4	M3	4.5	44.8	40	34	-	-	26	-
40														
50	60	23	30	3	M5	M4	4.5	64.8	60	54	47.5	42	45	40
63														
80														
100														
125														

For Ø [mm]	L1	L2	L3	L4	L5	L6	L7	L8	CRC ¹⁾	Weight [g]	Part No.	Type
32	45	37	30	27	19.2	17.5	-	4	1	76	2568514	DAVM-MW-V1-32-V
40												
50	60	52	40	31	30	25	20	-	1	160	2612128	DAVM-MW-V1-50-V
63												
80												
100												
125												

1) Corrosion resistance class CRC 1 to Festo standard FN 940070
 Low corrosion stress. For dry indoor applications or transport and storage protection. Also applies to parts behind covers, in the non-visible interior area, and parts which are covered in the application (e.g. drive trunnions).

Standard cylinders DSBC, to ISO 15552

Accessories

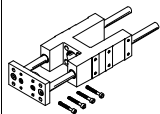
Ordering data – Guide units for fixed strokes (recirculating ball bearing guide only)				Technical data → Internet: feng		
	Stroke [mm]	Part No.	Type ¹⁾	Stroke [mm]	Part No.	Type ¹⁾
	For Ø 32 mm				For Ø 40 mm	
	10 ... 50	34493	FENG-32-50-KF	10 ... 50	34499	FENG-40-50-KF
	10 ... 100	34494	FENG-32-100-KF	10 ... 100	34500	FENG-40-100-KF
	10 ... 160	34495	FENG-32-160-KF	10 ... 160	34501	FENG-40-160-KF
	10 ... 200	34496	FENG-32-200-KF	10 ... 200	34502	FENG-40-200-KF
	10 ... 250	150289	FENG-32-250-KF	10 ... 250	34503	FENG-40-250-KF
	10 ... 320	34497	FENG-32-320-KF	10 ... 320	34504	FENG-40-320-KF
	10 ... 400	150290	FENG-32-400-KF	10 ... 400	150291	FENG-40-400-KF
	10 ... 500	34498	FENG-32-500-KF	10 ... 500	34505	FENG-40-500-KF
For Ø 50 mm				For Ø 63 mm		
	10 ... 50	34506	FENG-50-50-KF	10 ... 50	34513	FENG-63-50-KF
	10 ... 100	34507	FENG-50-100-KF	10 ... 100	34514	FENG-63-100-KF
	10 ... 160	34508	FENG-50-160-KF	10 ... 160	34515	FENG-63-160-KF
	10 ... 200	34509	FENG-50-200-KF	10 ... 200	34516	FENG-63-200-KF
	10 ... 250	34510	FENG-50-250-KF	10 ... 250	34517	FENG-63-250-KF
	10 ... 320	34511	FENG-50-320-KF	10 ... 320	34518	FENG-63-320-KF
	10 ... 400	150292	FENG-50-400-KF	10 ... 400	34519	FENG-63-400-KF
	10 ... 500	34512	FENG-50-500-KF	10 ... 500	34520	FENG-63-500-KF
For Ø 80 mm				For Ø 100 mm		
	10 ... 50	34521	FENG-80-50-KF	10 ... 50	34529	FENG-100-50-KF
	10 ... 100	34522	FENG-80-100-KF	10 ... 100	34530	FENG-100-100-KF
	10 ... 160	34523	FENG-80-160-KF	10 ... 160	34531	FENG-100-160-KF
	10 ... 200	34524	FENG-80-200-KF	10 ... 200	34532	FENG-100-200-KF
	10 ... 250	34525	FENG-80-250-KF	10 ... 250	34533	FENG-100-250-KF
	10 ... 320	34526	FENG-80-320-KF	10 ... 320	34534	FENG-100-320-KF
	10 ... 400	34527	FENG-80-400-KF	10 ... 400	34535	FENG-100-400-KF
	10 ... 500	34528	FENG-80-500-KF	10 ... 500	34536	FENG-100-500-KF

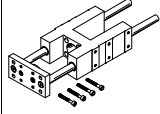
Ordering data – Guide units for variable strokes				Technical data → Internet: feng	
	For Ø [mm]	Stroke [mm]	With recirculating ball bearing guide Part No. Type ¹⁾	With plain-bearing guide Part No. Type ¹⁾	
		32	10 ... 500	34487 FENG-32-...-KF	34481
	40	10 ... 500	34488 FENG-40-...-KF	34482	FENG-40-...
	50	10 ... 500	34489 FENG-50-...-KF	34483	FENG-50-...
	63	10 ... 500	34490 FENG-63-...-KF	34484	FENG-63-...
	80	10 ... 500	34491 FENG-80-...-KF	34485	FENG-80-...
	100	10 ... 500	34492 FENG-100-...-KF	34486	FENG-100-...



1) ATEX-compliant

Standard cylinders DSBC, to ISO 15552

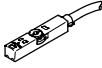
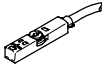
Accessories

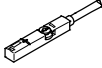
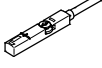
Ordering data – Proximity sensors for T-slot, magneto-resistive						Technical data → Internet: smt
	Type of mounting	Switching output	Electrical connection	Cable length [m]	Part No.	Type
N/O contact						
	Insertable in the slot from above, flush with the cylinder profile, short design	PNP	Cable, 3-wire	2.5	574335	SMT-8M-A-PS-24V-E-2,5-OE
			Plug M8x1, 3-pin	0.3	574334	SMT-8M-A-PS-24V-E-0,3-M8D
			Plug M12x1, 3-pin	0.3	574337	SMT-8M-A-PS-24V-E-0,3-M12
		NPN	Cable, 3-wire	2.5	574338	SMT-8M-A-NS-24V-E-2,5-OE
			Plug M8x1, 3-pin	0.3	574339	SMT-8M-A-NS-24V-E-0,3-M8D
N/C contact						
	Insertable in the slot from above, flush with the cylinder profile, short design	PNP	Cable, 3-wire	7.5	574340	SMT-8M-A-PO-24V-E-7,5-OE

Ordering data – Proximity sensors for T-slot, magnetic reed						Technical data → Internet: sme
	Type of mounting	Switching output	Electrical connection	Cable length [m]	Part No.	Type
N/O contact						
	Insertable in the slot from above, flush with the cylinder profile	Contacting	Cable, 3-wire	2.5	543862	SME-8M-DS-24V-K-2,5-OE
				5.0	543863	SME-8M-DS-24V-K-5,0-OE
			Cable, 2-wire	2.5	543872	SME-8M-ZS-24V-K-2,5-OE
				Plug M8x1, 3-pin	0.3	543861
N/C contact						
	Insertable in the slot from above, flush with the cylinder profile	Contacting	Cable, 3-wire	7.5	546799	SME-8M-DO-24V-K-7,5-OE

Ordering data – Connecting cables					Technical data → Internet: nebu
	Electrical connection, left	Electrical connection, right	Cable length [m]	Part No.	Type
	Straight socket, M8x1, 3-pin	Cable, open end, 3-wire	2.5	541333	NEBU-M8G3-K-2.5-LE3
			5	541334	NEBU-M8G3-K-5-LE3
	Straight socket, M12x1, 5-pin	Cable, open end, 3-wire	2.5	541363	NEBU-M12G5-K-2.5-LE3
			5	541364	NEBU-M12G5-K-5-LE3
	Angled socket, M8x1, 3-pin	Cable, open end, 3-wire	2.5	541338	NEBU-M8W3-K-2.5-LE3
			5	541341	NEBU-M8W3-K-5-LE3
	Angled socket, M12x1, 5-pin	Cable, open end, 3-wire	2.5	541367	NEBU-M12W5-K-2.5-LE3
			5	541370	NEBU-M12W5-K-5-LE3



Standard cylinders DSBC, to ISO 15552

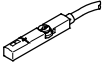

Accessories

Ordering data – Position transmitters for T-slot					Technical data → Internet: smat	
	Type of mounting	Electrical connection, connection direction	Analogue output [V]	Cable length [m]	Part No.	Type
	Insertable in slot from above	Plug M8x1, 4-pin, in-line	0 ... 10	0.3	553744	SMAT-8M-U-E-0,3-M8D

 Note

<p>Function : The position transmitter continuously senses the position of the piston. It has an analogue output with an output signal in proportion to the piston position.</p>	<p>Measuring range: The position transmitter supplies an analogue output signal of 0 ... 10 V in the position measuring range of up to 40 mm.</p>	<p>Information: Additional information can be found online → smat</p>
---	--	--

Ordering data – Connecting cables				Technical data → Internet: nebu	
	Electrical connection, left	Electrical connection, right	Cable length [m]	Part No.	Type
	Straight socket, M8x1, 4-pin	Cable, open end, 4-wire	2.5	541342	NEBU-M8G4-K-2.5-LE4
			5	541343	NEBU-M8G4-K-5-LE4
	Angled socket, M8x1, 4-pin	Cable, open end, 4-wire	2.5	541344	NEBU-M8W4-K-2.5-LE4
			5	541345	NEBU-M8W4-K-5-LE4

Ordering data				
	Description	Part No.	Type	PU ¹⁾
Slot cover for T-slot				
	Insertable, length 0.5 m	151680	ABP-5-S	2
Slot nut for T-slot				
	Insertable in the slot from above, thread M4	8028500	ABAN-8-1M4-5-P2	2
		8028501	ABAN-8-1M4-5-P100	100

1) Packaging unit quantity