

Standard cylinders DSNU/DSNUP/DSN/ESNU/ESN, ISO 6432

FESTO

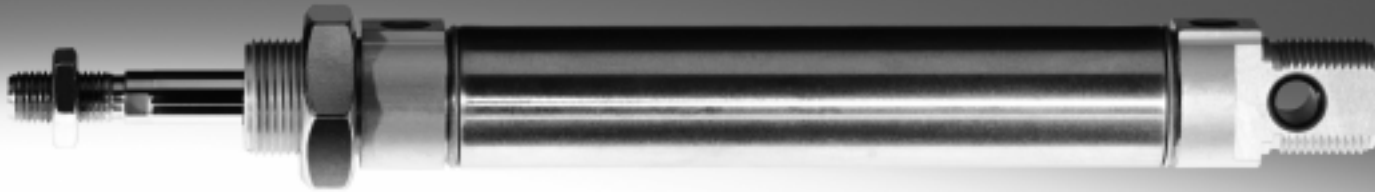

Standard cylinders DSNU/DSNUP/DSN/ESNU/ESN, ISO 6432

Key features

At a glance



ISO 6432
DIN ISO 6432



- Round cylinders with piston diameters from 8 to 25 mm conform to ISO 6432, DIN ISO 6432. Variants are based on these standards
- The series is not repairable
- Stainless steel piston rod
- The cap is roller burnished onto the barrel

Wide choice of variants

DSNU-...

- Cylinder barrel made of stainless steel
- Bearing and end caps made of wrought aluminium alloy



DSNUP-...

- Cylinder barrel made of wrought aluminium alloy
- Bearing and end caps made of polyamide
- Cost optimised



DSNU/ESNU-...MA

- Threaded bearing cap
- Short end cap with axial supply port



DSNU-...MQ

- Threaded bearing cap
- Short end cap with lateral supply port



DSNU-...MH

- Direct mounting on bearing cap
- Short end cap with lateral supply port



DSNU-...KP

- With clamping unit



DSNU-...Q

- With square piston rod



Cushioning types

Cushioning P

Mode of operation

- The drive is fitted with flexible polymer end position cushioning

Application

- Small loads
- Low speeds
- Low impact energy

Advantages

- No adjustment required
- Time-saving

Cushioning PPS

- The drive is fitted with self-adjusting end position cushioning

- Small to medium loads
- Low to medium speeds
- Medium impact energy

- No adjustment required
- Time-saving
- Powerful

Cushioning PPV











- The drive is fitted with adjustable end position cushioning

- Medium to large loads
- High speeds
- High impact energy

- Very powerful

Standard cylinders DSNU/DSNUP/DSN/ESNU/ESN, ISO 6432

Key features

Additional variants		
Symbol	Key features	Description
	S2 Through piston rod	For working at both ends with the same force in the advance and return stroke, for attaching external stops
	S6 Heat resistant seals	Temperature resistance up to max. 120 °C
	S10 Constant (slow speed) operation at low piston speeds	Suitable for slow stroke movements at a constant, stick-slip-free speed over the full stroke of the cylinder. Seal contains silicone grease (not free of paint-wetting impairment substances)
	S11 Low friction	The special seals considerably reduce system wear. This corresponds to a considerably lower response pressure. Seal contains silicone grease (not free of paint-wetting impairment substances)
	K2 Extended male piston rod thread	–
	K3 Female piston rod thread	–
	K5 Special thread on piston rod	Metric standard thread to ISO
	K6 Shortened male piston rod thread	–
	K8 Extended piston rod	–
	R3 High corrosion protection	All external cylinder surfaces comply with corrosion resistance class 3 to Festo standard 940 070. The piston rod is made from corrosion and acid resistant steel

Longer service life with bellows kit DADB



The bellows kit is a leak-free system. To prevent unwanted media from being drawn in, the supply and exhaust air of the kit must be ducted via a pressure compensation hole in the connection section 1.

The kit protects the piston rod, seal and bearing against a wide variety of media, for example:

- dust
- chippings
- oil
- grease
- fuel

Standard cylinders DSNU/DSNUP/DSN, ISO 6432

Product range overview

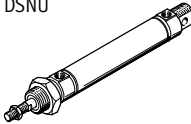
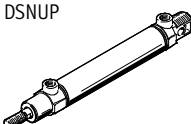
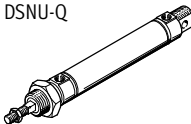
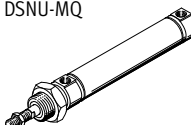
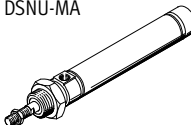
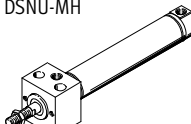
Function	Version	Piston Ø [mm]	Stroke [mm]	Variable stroke ¹⁾ [mm]	Piston rod					Female thread K3	
					Through S2	Extended K8	Male thread				
							Extended K2	Shortened K6	Special thread K5		
Double-acting	Basic version with position sensing (cylinder barrel made of stainless steel)										
	 DSNU	8, 10	10, 15, 20, 25,	1 ... 100	■	■	■	■	■	■	■
		12, 16	30, 35, 40, 50,	1 ... 200							
		20	60, 70, 80, 100,	1 ... 320							
		25	125, 150, 160, 200, 250, 300, 320, 400, 500	1 ... 500							
	DSNU – Round cylinder with piston Ø 32 ... 63										
	Basic version with or without position sensing (cylinder barrel made of aluminium)										
	 DSNUP	16	25, 50, 100	2)	-	-	-	-	-	-	-
		20									
		25									
	DSNUP – Round cylinder with piston Ø 32 ... 63										
	Protected against rotation										
 DSNU-Q	12, 16	-	5 ... 160	■	■	■	■	■	■	■	
	20	-	5 ... 200								
	25	-	5 ... 250								
DSNU-Q – Round cylinder with piston Ø 32 ... 63											
Lateral air connection											
 DSNU-MQ	8, 10	-	1 ... 100	-	■	■	■	■	■	■	
	12, 16	-	1 ... 200								
	20	-	1 ... 320								
	25	-	1 ... 500								
DSNU-MQ – Round cylinder with piston Ø 32 ... 63											
Axial air connection											
 DSNU-MA	8, 10	-	1 ... 100	-	■	■	■	■	■	■	
	12, 16	-	1 ... 200								
	20	-	1 ... 320								
	25	-	1 ... 500								
DSNU-MA – Round cylinder with piston Ø 32 ... 63											
Direct mounting											
 DSNU-MH	8, 10	-	1 ... 100	-	■	■	■	■	■	■	
	12, 16	-	1 ... 200								
	20	-	1 ... 320								
	25	-	1 ... 500								
DSNU-MH – Round cylinder with piston Ø 32 ... 63											

1) Cylinders with position sensing require a minimum stroke of 10 mm to ensure reliable sensing

2) Variable stroke on request

Standard cylinders DSNU/DSNUP/DSN, ISO 6432

Product range overview

Version	Cushioning			Position sensing	Clamping unit	Heat-resistant seal	Slow speed (constant motion operation)	Low friction	Corrosion protection	→ Page/ Internet
	Fixed	Adjustable	Self-adjusting							
	P	∅ 16 and above PPV ³⁾	∅ 16 and above PPS	A	KP	S6	S10	S11	R3	
Basic version with position sensing (cylinder barrel made of stainless steel)										
DSNU	■	■	■	■	■	■	■	■	■	12
DSNU – Round cylinder with piston ∅ 32 ... 63										dsnu
Basic version with or without position sensing (cylinder barrel made of aluminium)										
DSNUP	■	-	-	■	-	-	-	-	-	24
Protected against rotation										
DSNU-Q	■ ∅ 12	■ ∅ 16 ... 25	-	■	■	-	-	-	■ ∅ 12 ... 25	27
DSNU-Q – Round cylinder with piston ∅ 32 ... 63										dsnu
Lateral air connection										
DSNU-MQ	■	■	■	■	■	■	-	-	■	12
DSNU-MQ – Round cylinder with piston ∅ 32 ... 63										dsnu
Axial air connection										
DSNU-MA	■	-	-	■	■	■	-	-	■	12
DSNU-MA – Round cylinder with piston ∅ 32 ... 63										dsnu
Direct mounting										
DSNU-MH	■	■	-	■	-	■	-	-	■	12
DSNU-MH – Round cylinder with piston ∅ 32 ... 63										dsnu

3) In the modular product system from ∅ 12 mm

Standard cylinders ESNU/ESN, ISO 6432

Product range overview

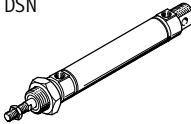
Function	Version	Piston Ø [mm]	Stroke [mm]	Variable stroke ¹⁾ [mm]	Piston rod						
					Through S2	Extended K8	Male thread			Female thread K3	
							Extended K2	Shortened K6	Special thread K5		
Double-acting	Basic version without position sensing										
		DSN	8, 10	10, 25, 40, 50,	1 ... 100	-	-	-	-	-	-
		12, 16	80, 100, 125,	1 ... 200							
		20	160, 200, 250,	1 ... 320							
		300, 320, 400,	1 ... 500								
25		500									

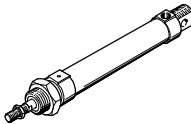
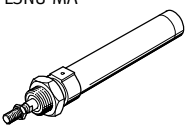
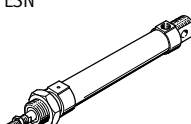
Function	Version	Piston Ø [mm]	Stroke [mm]	Variable stroke ¹⁾ [mm]	Cushioning	Position sensing	
					Fixed P	A	
Single-acting	Basic version with position sensing						
		ESNU	8, 10, 12, 16, 20, 25	10, 25, 50	1 ... 50	■	■
		ESNU – Round cylinder with piston Ø 32 ... 63					
	Axial air connection						
		ESNU-MA	8, 10, 12, 16, 20, 25	-	1 ... 50	■	■
		ESNU-MA – Round cylinder with piston Ø 32 ... 63					
Basic version without position sensing							
	ESN	8, 10, 12, 16, 20, 25	10, 25, 50	1 ... 50	■	-	

1) Cylinders with position sensing require a minimum stroke of 10 mm to ensure reliable sensing

Standard cylinders ESNU/ESN, ISO 6432

Product range overview

Version	Cushioning			Position sensing	Clamping unit	Heat-resistant seal	Slow speed (constant motion operation)	Low friction	Corrosion protection	→ Page/Internet
	Fixed	Adjustable	Self-adjusting							
	P	∅ 16 and above PPV ²⁾	∅ 16 and above PPS	A	KP	S6	S10	S11	R3	
Basic version without position sensing										
DSN	■	■	-	-	-	-	-	-	-	48

Version	Piston rod					→ Page/Internet
	Extended	Male thread			Female thread	
		Extended	Shortened	Special thread		
	K8	K2	K6	K5	K3	
Basic version with position sensing						
ESNU	■	■	■	■	■	40
ESNU – Round cylinder with piston ∅ 32 ... 63						esnu
Axial air connection						
ESNU-MA	■	■	■	■	■	40
ESNU-MA – Round cylinder with piston ∅ 32 ... 63						esnu
Basic version without position sensing						
ESN	-	-	-	-	-	54

2) In the modular product system from ∅ 12 mm

Standard cylinders DSNU/DSNUP/DSN/ESNU/ESN, ISO 6432

Peripherals overview

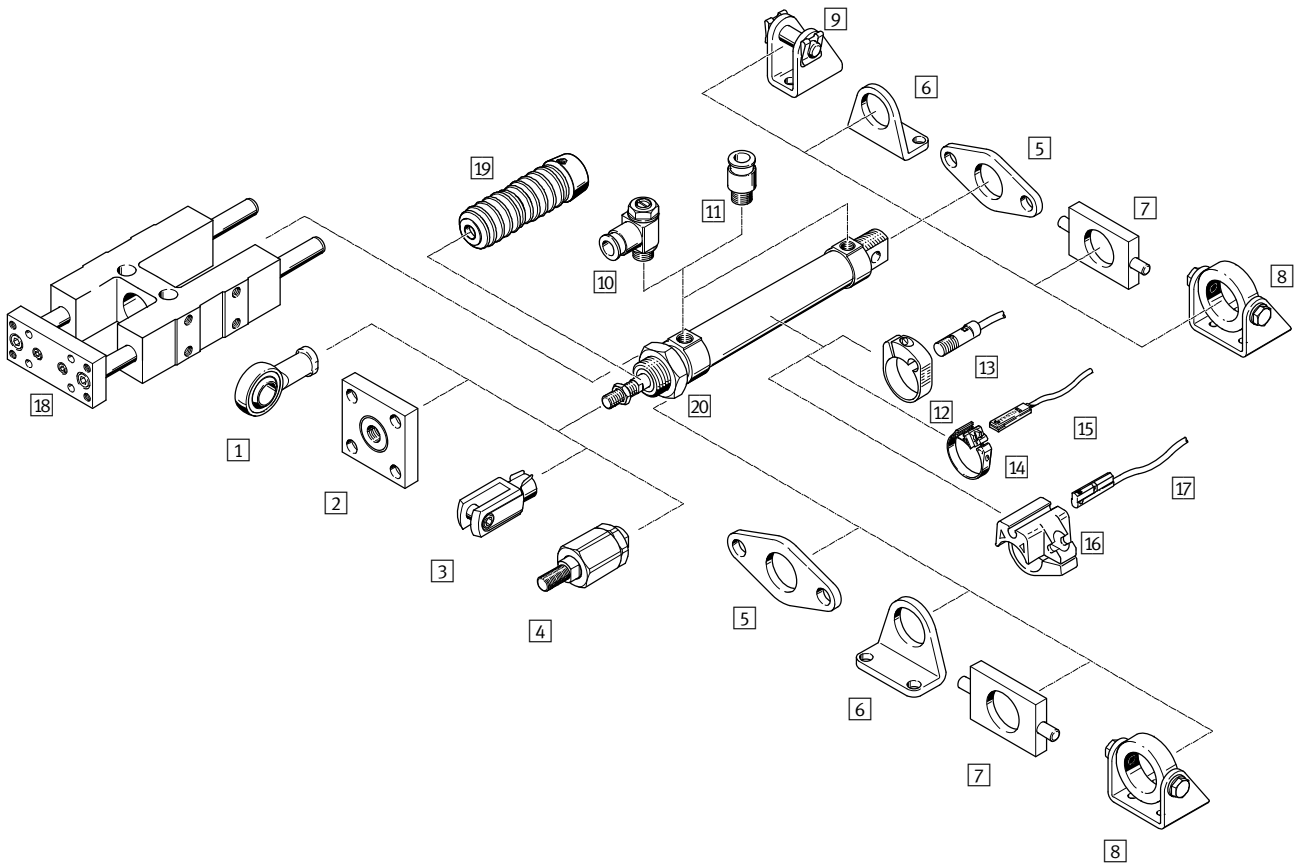

Variants

DSNU-MQ

DSNU-MA

DSNU-MH

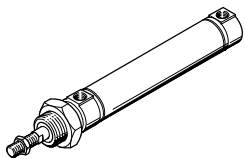

DSNU-Q

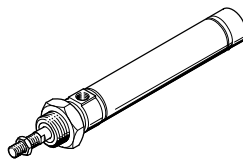

DSNU-KP

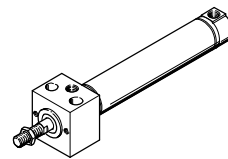

Mounting options

Mounting front and rear

Mounting with hex nut

Swivel mounting

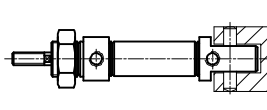
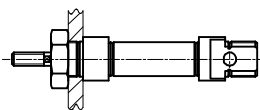
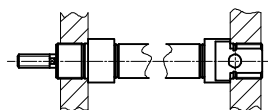

Installation variants with mounting attachments

Foot mounting (for short strokes)

Foot mounting

Flange mounting

Swivel mounting

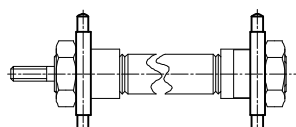
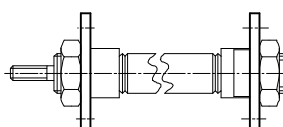
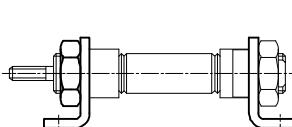
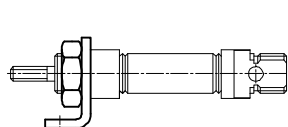

Standard cylinders DSNU/DSNUP/DSN/ESNU/ESN, ISO 6432

Peripherals overview

Mounting attachments and accessories									
	DSNU/ ESNU	DSNUP	DSNU/ ESNU	DSNU			DSNU-Q	DSN/ESN	→ Page/Internet
			MA	MQ	MH	KP			
1	Rod eye SGS/CRSGS	■	■	■	■	■	■	■	61
2	Coupling piece KSG/KSZ	■	■	■	■	■	■	■	61
3	Rod clevis SG/CRSG	■	■	■	■	■	■	■	61
4	Self-aligning rod coupler FK/CRFK	■	■	■	■	■	■	■	61
5	Flange mounting FBN/CRFBN	■	■	■	■	-	■	■	59
6	Foot mounting HBN/CRHBN	■	■	■	■	-	■	■	58
7	Swivel mounting ¹⁾ WBN	■	■	■	■	-	■	■	60
8	Swivel mounting ¹⁾ SBN	■	-	■	■	-	■	■	59
9	Clevis foot LBN/CRLBN	■	■	-	-	-	■	■	60
10	One-way flow control valve ²⁾ GRLA/GRLZ/CRGRLA	■	■	■	■	■	■	■	69
11	Push-in fitting ²⁾ QS	■	■	■	■	■	■	■	quick star
12	Mounting kit SMBR/CRSMBR	■	-	■	■	■	■	-	66
13	Proximity sensor SMEO/SMTO/CRSMEO-4	■	-	■	■	■	■	-	66
14	Mounting kit SMBR-8	■	■	■	■	■	■	-	67
15	Proximity sensor SME/SMT-8	■	■	■	■	■	■	-	67
16	Mounting kit SMBR-10	■	-	■	■	■	■	-	68
17	Proximity sensor SME/SMT-10	■	-	■	■	■	■	-	68
18	Guide unit FEN	■	-	■	■	-	-	■	61
19	Bellows kit ³⁾ DADB	■	-	■	■	-	-	-	62
20	Hex nut MSK	■	-	■	■	■	■	■	61

 Note

- | | | | |
|---|---|---|---|
| <p>1) Cannot be used on the bearing cap in combination with bellows kit DADB.</p> | <p>2) Only push-in fittings or one-way flow control valves with cylindrical connecting thread (M or G thread) may be used for the compressed air ports in conjunction with the DSNUP.</p> | <p>3) The bellows kit protects the cylinder (piston rod, seal and bearings) against a wide range of media and thus prevents premature wear.</p> | <p>It can only be used in combination with an extended piston rod (K8).</p> |
|---|---|---|---|

Standard cylinders DSNU/DSNUP/DSN/ESNU/ESN, ISO 6432

Type codes

DSNU – 25 – 80 – PPV – A – MQ

Type	
Double-acting	
DSNU/DSN	Standard cylinder
Single-acting	
ESNU/ESN	Standard cylinder
Piston Ø [mm]	
25	
Stroke [mm]	
80	
Cushioning	
P	Flexible cushioning rings/pads at both ends
PPV	Pneumatic cushioning, adjustable at both ends
PPS	Pneumatic cushioning, self-adjusting at both ends
Position sensing	
A	Via proximity sensor
Variant	
MQ	Lateral air connection
MA	Axial air connection
MH	With mounting flange on bearing cap

Modular product system

Individually configurable

DSNU → 36

ESNU → 46

- Square piston rod (protection against rotation)
- Through piston rod (piston rod type)
- Extended male piston rod thread
- Male piston rod thread, shortened at one end
- Female piston rod thread (female thread)
- Special piston rod thread (special thread)
- Extended piston rod at front
- Clamping unit on the piston rod
- Heat-resistant seals for temperatures up to 120 °C (temperature resistance)
- Slow speed (constant motion at low piston rod speeds)
- Low friction
- ATEX certification II 2GD
- All external cylinder surfaces conform to corrosion resistance class CRC 3 (corrosion protection)

Standard cylinders DSNU/DSNUP/DSN/ESNU/ESN, ISO 6432

Type codes

		DSNUP	-	20	-	50	-	P	-	A
Type										
Double-acting										
DSNUP	Standard cylinder									
Piston Ø [mm]										
Stroke [mm]										
Cushioning										
P	Flexible cushioning rings/pads at both ends									
Position sensing										
A	Via proximity sensor									

Standard cylinders DSNU, ISO 6432

Technical data

Function

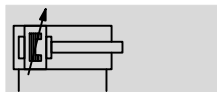
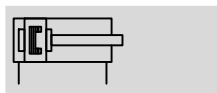

Variants

→ 18

⌀ - Diameter
8 ... 25 mm

— - Stroke length
1 ... 500 mm

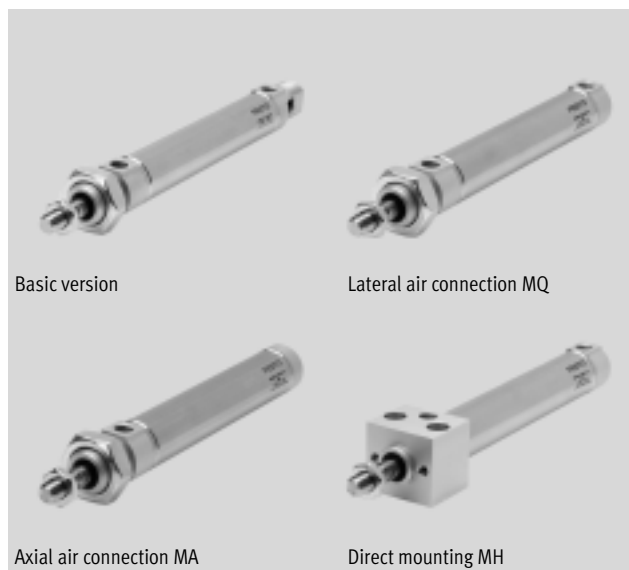

General technical data			8	10	12	16	20	25	
Piston Ø			8	10	12	16	20	25	
Pneumatic connection			M5	M5	M5	M5	G1/8	G1/8	
Piston rod thread			M4	M4	M6	M6	M8	M10x1.25	
Constructional design			Piston						
			Piston rod						
			Cylinder barrel						
Cushioning	P		Flexible cushioning rings/pads at both ends						
	PPV		-			Adjustable cushioning at both ends			
	PPS		-			Self-adjusting cushioning at both ends			
Cushioning length	PPV	[mm]	-			9	12	15	17
	PPS	[mm]	-			12	15	17	
Position sensing			Via proximity sensor						
Type of mounting			Direct mounting (MH variant only)						
			Via accessories						
Mounting position			Any						

|| - Note: This product conforms to ISO 1179-1 and to ISO 228-1

Operating conditions			8	10	12	16	20	25
Piston Ø			8	10	12	16	20	25
Operating medium			Compressed air in accordance with ISO 8573-1:2010 [7:4:4]					
Note on operating/pilot medium			Operation with lubricated medium possible (in which case lubricated operation will always be required)					
Operating pressure	Basic version	[bar]	1.5 ... 10 ¹⁾			1 ... 10		
	S10		-			1.5 ... 10		1 ... 10
	S11		-			0.45 ... 10		0.3 ... 10

1) With DSNU-12- ... -PPV (pneumatic cushioning adjustable at both ends): 2 ... 10 bar

Standard cylinders DSNU, ISO 6432

Technical data

Ambient conditions						
Standard cylinder	Basic version	S6	S10	S11	R3	
Ambient temperature ¹⁾	[°C]	-20 ... +80	0 ... +120	+5 ... +80		-20 ... +80
Corrosion resistance class CRC ²⁾		2	2	2	2	3

1) Note operating range of proximity sensors.

2) Corrosion resistance class 2 as per Festo standard 940 070

Components subject to moderate corrosion stress. Externally visible parts with primarily decorative surface requirements which are in direct contact with a normal industrial environment or media such as coolants or lubricating agents.

Corrosion resistance class 3 as per Festo standard 940 070

Components requiring higher corrosion resistance. External visible parts in direct contact with industrial atmospheres or media such as solvents and cleaning agents, with a predominantly functional requirement for the surface.

ATEX ¹⁾	
ATEX category for gas	II 2G
Explosion ignition protection type for gas	c T4
ATEX category for dust	II 2D
Explosion ignition protection type for dust	c 120°C
Explosion-proof temperature rating	-20°C ≤ Ta ≤ +60°C
CE marking (see declaration of conformity)	To EU Explosion Protection Directive (ATEX)

1) Make sure that the accessories are suited for ATEX application.

Speed [mm/s]						
Piston Ø		16	20	25		
Speed with stick-slip-free operation, horizontal, without load, at 6 bar	S10	10 ... 100				
Minimum speed, advancing	S11	2.7	5.3	<1 ¹⁾		
Minimum speed, retracting	S11	3.2	4.7	<1 ¹⁾		

1) Measurements of less than 1 mm/s were not conducted

Force [N] and impact energy [J]							
Piston Ø		8	10	12	16	20	25
Theoretical force at 6 bar, advancing		30	47	68	121	189	295
Theoretical force at 6 bar, retracting		23	40	51	104	158	247
Max. impact energy at the end positions for flexible cushioning elements ¹⁾		0.03	0.05	0.07	0.15	0.20	0.30

1) The values are reduced by approx. 50% at an ambient temperature of 80 °C

Standard cylinders DSNU, ISO 6432

Technical data

Average piston speed v as a function of applied load m in combination with PPS cushionings

Piston \varnothing 16

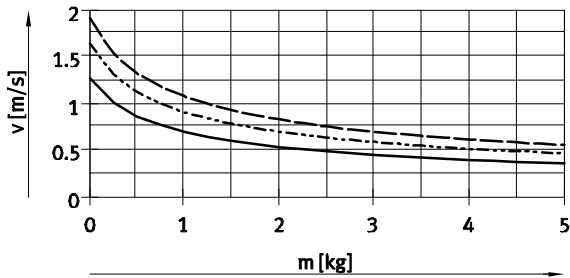

- DSNU-16-50
- - - DSNU-16-100
- · - DSNU-16-200

Piston \varnothing 20

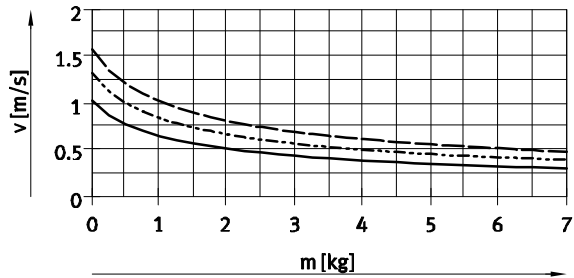

- DSNU-20-50
- - - DSNU-20-100
- · - DSNU-20-200

Piston \varnothing 25

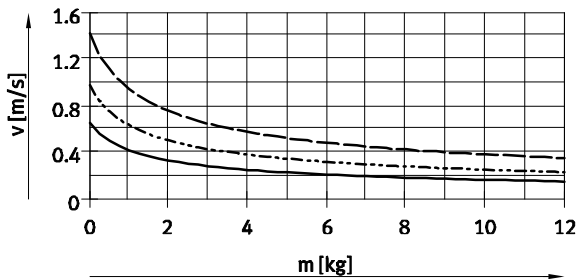

- DSNU-25-50
- - - DSNU-25-100
- · - DSNU-25-200

- - Note

Average piston speed
= stroke/movement time

- - Note

Design software
for flexible cushioning elements
→ ProDrive

Additional graphs
for PPS cushioning
→ www.festo.com

Design software
for PPV cushioning
→ ProDrive

Standard cylinders DSNU, ISO 6432

Technical data

Weight [g]						
Piston \varnothing	8	10	12	16	20	25
Product weight with 0 mm stroke	34.6	37.3	75	89.9	186.8	238
Additional weight per 10 mm stroke	2.4	2.7	4	4.6	7.2	11

Max. lateral force F_q as a function of stroke length l

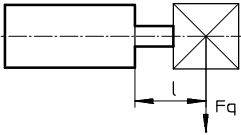

Basic version

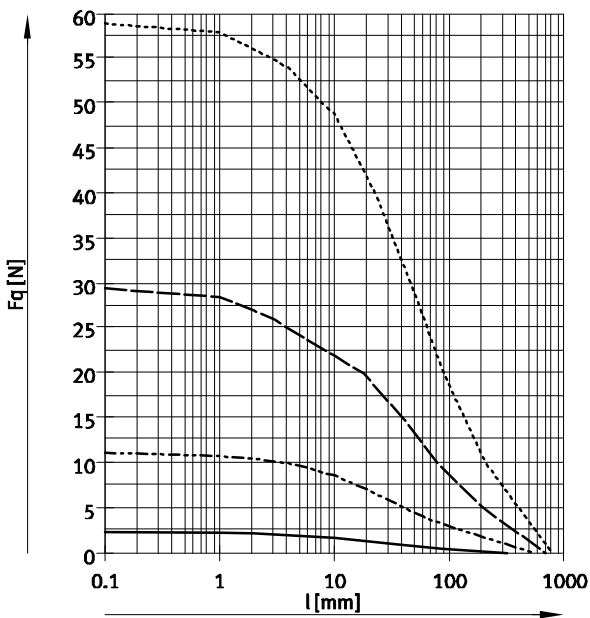

S2 – Through piston rod

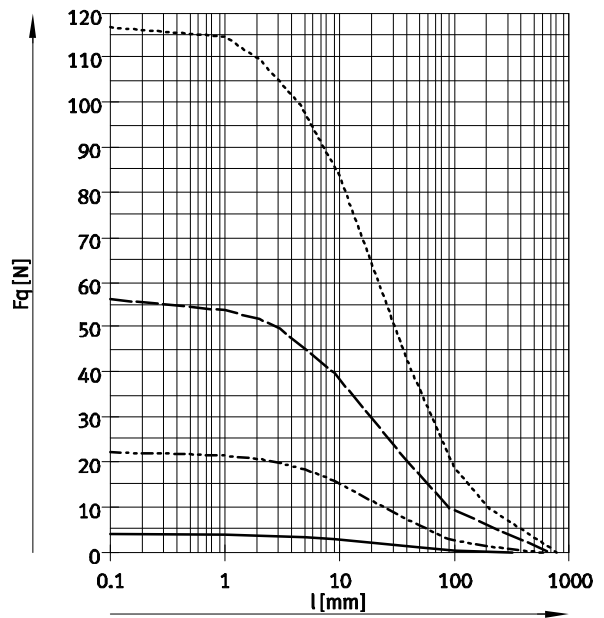

- \varnothing 8/10
- - - \varnothing 12/16
- — — \varnothing 20
- · - · \varnothing 25

Materials

Sectional view

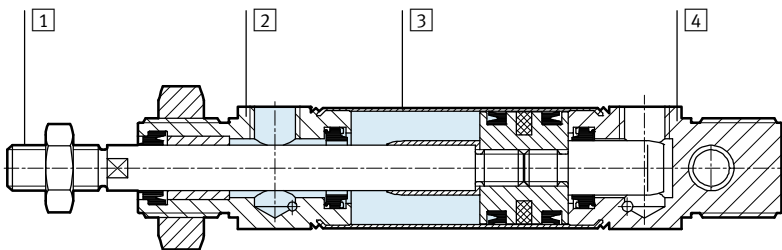

Standard cylinder	Basic version	R3	S6	S10	S11
1 Piston rod	High-alloy stainless steel				
2 Bearing cap	Anodised aluminium				
3 Cylinder barrel	High-alloy stainless steel				
4 End cap	Anodised aluminium				
- Seals	Polyurethane, nitrile rubber		Fluoro elastomer		
Note on materials	RoHS compliant				

Standard cylinders DSNU, ISO 6432

Technical data

Dimensions

Download CAD data → www.festo.com

Basic version

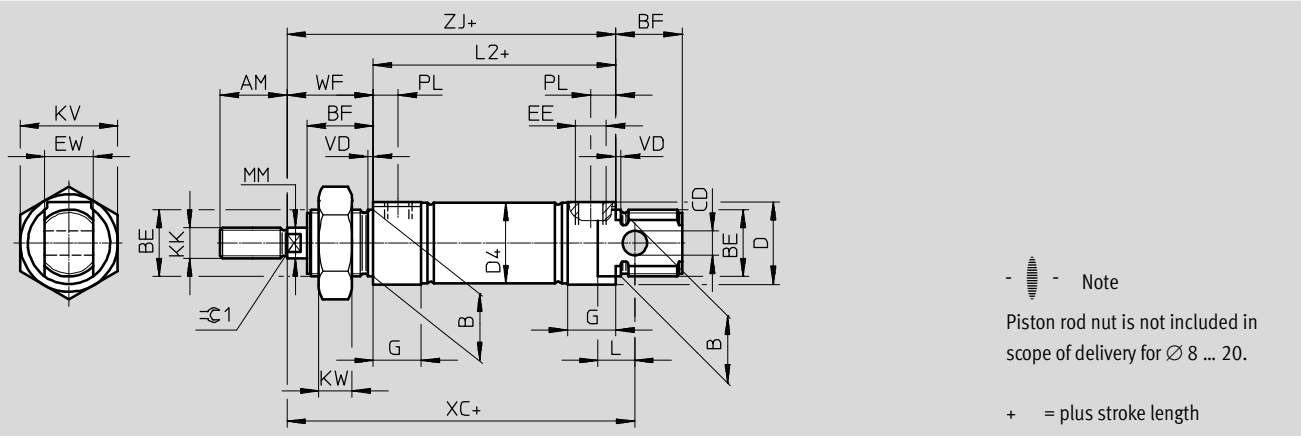

∅ [mm]	AM	B ∅ h9	BE	BF	CD ∅ H9	D ∅	D4 ∅	EE	EW	G	KK	KV
8	12	12	M12x1.25	12	4	15	9.3	M5	8	10	M4	19
10							11.3					
12	16	16	M16x1.5	17	6	20	13.3		12	16	M6	24
16							17.3					
20	20	22	M22x1.5	20	8	27	21.3	G1/8	16	16	M8	32
25				22			22					

∅ [mm]	KW	L	L2	MM ∅	PL	VD	WF	XC ±1	ZJ	≈C1
8	6	6	46	4	6	2	16	64	62	-
10			50							
12	8	9	56	6	8.2		22	75	72	5
16			68							
20	11	12	69.5	10	8.2	24	95	92	7	
25			28							104

Note: This product conforms to ISO 1179-1 and to ISO 228-1

Standard cylinders DSNU, ISO 6432

Technical data

Dimensions

Download CAD data → www.festo.com

MQ – Lateral air connection

MA – Axial air connection

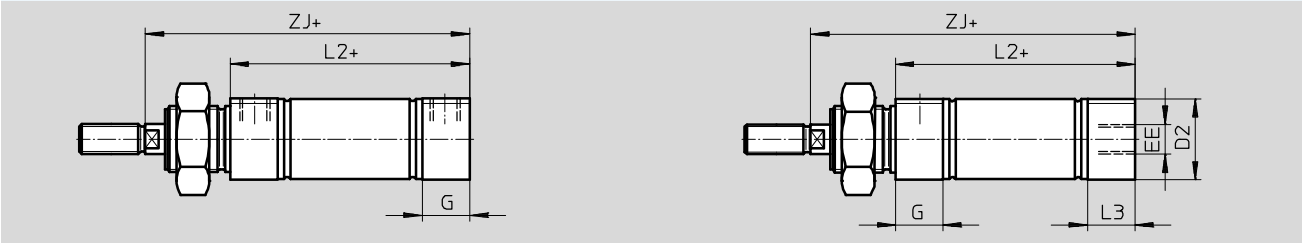

MH – With direct mounting

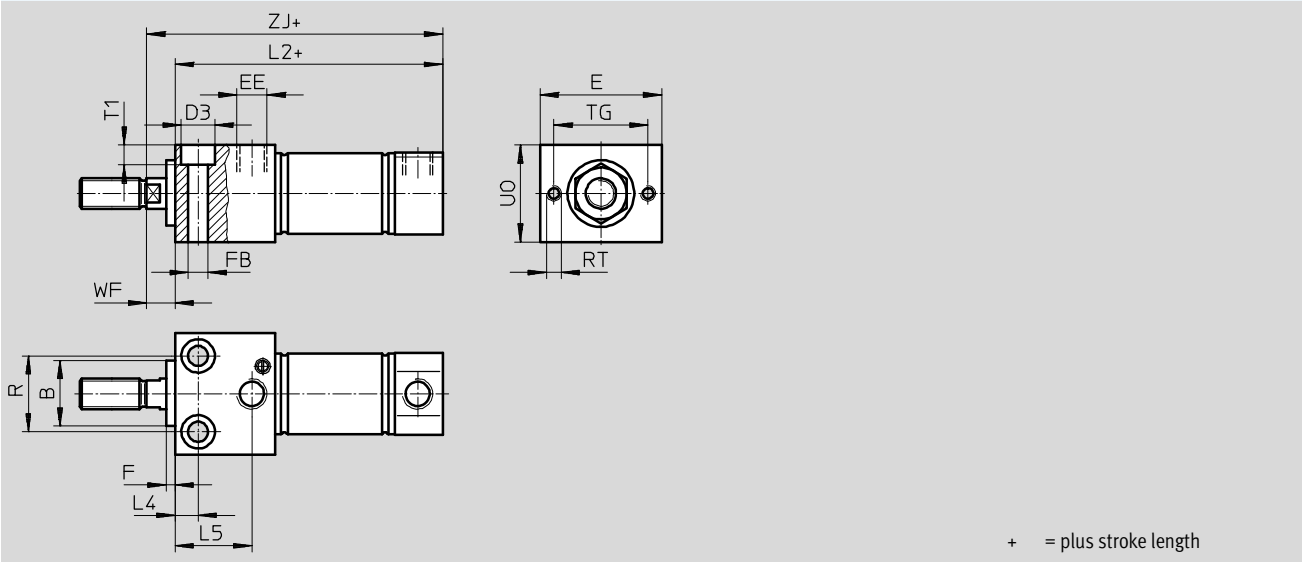

+ = plus stroke length

∅ [mm]	B ∅ h9	D2 ∅	D3 ∅	E	EE	F	FB ∅	G	L2		
									-MQ	-MA	-MH
8	12	10.5	6	24	M5	3	3.4	10	46	43.6	53.5
10		12.5								43.1	53.8
12	16	14.5	8	30			4.5		50	47.7	62
16		17.5								53.7	67.5
20	22	21.7	10	40	G1/8	5.5	16	68	66.5	81.5	
25		26.7	11			6.6		69.5	68.5	86.2	

∅ [mm]	L3	L4	L5	R	RT	TG	T1	UO	WF	ZJ		
										-MQ	-MA	-MH
8	7.6	5	14	12	M3	18	3.4	16	8	62	59.6	61.5
10	7.1										59.1	61.8
12	7.7	6	18.1	16	M4	23	4.5	22	10	72	69.7	72
16										78	75.7	77.8
20	14.5	7.5	22.4	22	M5	31	5.5	28	11	92	90.5	91.5
25	14		25.2	25			6.6			32	97.5	96.5

• Note: This product conforms to ISO 1179-1 and to ISO 228-1

Standard cylinders DSNU, ISO 6432

Technical data

Dimensions Download CAD data → www.festo.com

S2 – Through piston rod

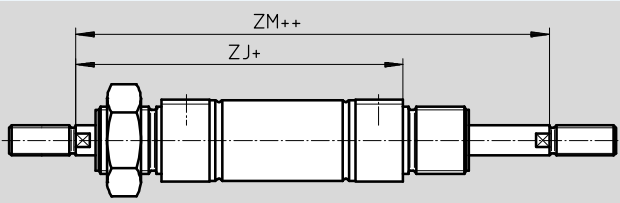

Note
The thread types at both piston rod ends are identical. In combination with variant Q, the left-hand piston rod end is square, the right-hand piston rod end round.

+ = plus stroke length
++ = plus 2x stroke length

K2 – Extended male piston rod thread

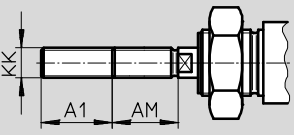

K6 – Shortened male piston rod thread

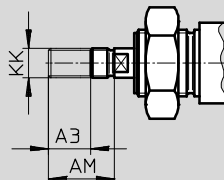

K3 – Female piston rod thread

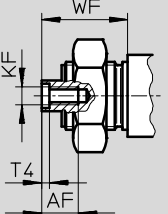

K5 – Special thread on piston rod

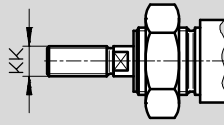

K8 – Extended piston rod

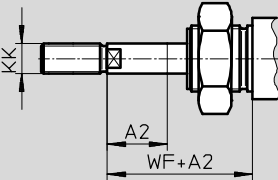

Note
If variant K8 is required in combination with S2, the piston rod will only be extended on one side.

∅ [mm]	A1 max.	A2 max.	A3 max.	AM	AF	KF	KK		T4	WF	ZJ			ZM
							Basic thread	Special thread ¹⁾			-MQ	-MA	-MH	
8	15	50	4	12	-	-	M4	-	-	16	62	59.6	61.5	78.4
10					-	-		-	-			59.1	61.8	
12	20	100		16	-	-	M6	-	-	22	72	69.7	72	94
16					-	-		-	-			78	75.7	
20	25	110	8	20	12	M4	M8	-	2	24	92	90.5	91.5	116
25	35	150		22		M6	M10x1.25	M10	2.6	28	97.5	96.5	97.2	125.5

1) The special threads are only available as male threads. The scope of delivery does not include a hex nut for the piston rod thread.

Standard cylinders DSNU, ISO 6432

Technical data

Ordering data					
Piston \varnothing [mm]	Stroke [mm]	P – Flexible cushioning rings/pads at both ends A – With position sensing		PPV – Pneumatic cushioning, adjustable at both ends A – With position sensing	
		Part No.	Type	Part No.	Type
Basic version					
8	10	19177	DSNU-8-10-P-A	-	
	15	1908247	DSNU-8-15-P-A		
	20	1908248	DSNU-8-20-P-A		
	25	19178	DSNU-8-25-P-A		
	30	1908249	DSNU-8-30-P-A		
	40	19179	DSNU-8-40-P-A		
	50	19180	DSNU-8-50-P-A		
	60	1908250	DSNU-8-60-P-A		
	80	19181	DSNU-8-80-P-A		
	100	19182	DSNU-8-100-P-A		
10	10	19183	DSNU-10-10-P-A	-	
	15	1908251	DSNU-10-15-P-A		
	20	1908252	DSNU-10-20-P-A		
	25	19184	DSNU-10-25-P-A		
	30	1908253	DSNU-10-30-P-A		
	40	19185	DSNU-10-40-P-A		
	50	19186	DSNU-10-50-P-A		
	60	1908254	DSNU-10-60-P-A		
	80	19187	DSNU-10-80-P-A		
	100	19188	DSNU-10-100-P-A		
12	10	19189	DSNU-12-10-P-A	-	
	15	1908255	DSNU-12-15-P-A		
	20	1908256	DSNU-12-20-P-A		
	25	19190	DSNU-12-25-P-A		
	30	1908257	DSNU-12-30-P-A		
	40	19191	DSNU-12-40-P-A		
	50	19192	DSNU-12-50-P-A		
	60	1908258	DSNU-12-60-P-A		
	80	19193	DSNU-12-80-P-A		
	100	19194	DSNU-12-100-P-A		
	125	19195	DSNU-12-125-P-A		
160	19196	DSNU-12-160-P-A			
	200	19197	DSNU-12-200-P-A		
16	10	19198	DSNU-16-10-P-A	1908266	DSNU-16-10-PPV-A
	15	1908259	DSNU-16-15-P-A	1908267	DSNU-16-15-PPV-A
	20	1908260	DSNU-16-20-P-A	1908268	DSNU-16-20-PPV-A
	25	19199	DSNU-16-25-P-A	33973	DSNU-16-25-PPV-A
	30	1908261	DSNU-16-30-P-A	1908269	DSNU-16-30-PPV-A
	35	1908262	DSNU-16-35-P-A	1908270	DSNU-16-35-PPV-A
	40	19200	DSNU-16-40-P-A	19229	DSNU-16-40-PPV-A
	50	19201	DSNU-16-50-P-A	19230	DSNU-16-50-PPV-A
	60	1908263	DSNU-16-60-P-A	1908271	DSNU-16-60-PPV-A
	70	1908264	DSNU-16-70-P-A	1908272	DSNU-16-70-PPV-A
	80	19202	DSNU-16-80-P-A	19231	DSNU-16-80-PPV-A
	100	19203	DSNU-16-100-P-A	19232	DSNU-16-100-PPV-A
	125	19204	DSNU-16-125-P-A	19233	DSNU-16-125-PPV-A
	150	1908265	DSNU-16-150-P-A	1908273	DSNU-16-150-PPV-A
	160	19205	DSNU-16-160-P-A	19234	DSNU-16-160-PPV-A
	200	19206	DSNU-16-200-P-A	19235	DSNU-16-200-PPV-A

Standard cylinders DSNU, ISO 6432

Technical data

Ordering data					
Piston \varnothing [mm]	Stroke [mm]	P – Flexible cushioning rings/pads at both ends A – With position sensing		PPV – Pneumatic cushioning, adjustable at both ends A – With position sensing	
		Part No.	Type	Part No.	Type
Basic version					
20	10	19207	DSNU-20-10-P-A	1908289	DSNU-20-10-PPV-A
	15	1908282	DSNU-20-15-P-A	1908290	DSNU-20-15-PPV-A
	20	1908283	DSNU-20-20-P-A	1908291	DSNU-20-20-PPV-A
	25	19208	DSNU-20-25-P-A	33974	DSNU-20-25-PPV-A
	30	1908284	DSNU-20-30-P-A	1908292	DSNU-20-30-PPV-A
	35	1908285	DSNU-20-35-P-A	1908293	DSNU-20-35-PPV-A
	40	19209	DSNU-20-40-P-A	19236	DSNU-20-40-PPV-A
	50	19210	DSNU-20-50-P-A	19237	DSNU-20-50-PPV-A
	60	1908286	DSNU-20-60-P-A	1908294	DSNU-20-60-PPV-A
	70	1908287	DSNU-20-70-P-A	1908295	DSNU-20-70-PPV-A
	80	19211	DSNU-20-80-P-A	19238	DSNU-20-80-PPV-A
	100	19212	DSNU-20-100-P-A	19239	DSNU-20-100-PPV-A
	125	19213	DSNU-20-125-P-A	19240	DSNU-20-125-PPV-A
	150	1908288	DSNU-20-150-P-A	1908296	DSNU-20-150-PPV-A
	160	19214	DSNU-20-160-P-A	19241	DSNU-20-160-PPV-A
	200	19215	DSNU-20-200-P-A	19242	DSNU-20-200-PPV-A
	250	19216	DSNU-20-250-P-A	19243	DSNU-20-250-PPV-A
300	19217	DSNU-20-300-P-A	19244	DSNU-20-300-PPV-A	
320	34718	DSNU-20-320-P-A	34720	DSNU-20-320-PPV-A	
25	10	19218	DSNU-25-10-P-A	1908312	DSNU-25-10-PPV-A
	15	1908305	DSNU-25-15-P-A	1908313	DSNU-25-15-PPV-A
	20	1908306	DSNU-25-20-P-A	1908314	DSNU-25-20-PPV-A
	25	19219	DSNU-25-25-P-A	33975	DSNU-25-25-PPV-A
	30	1908307	DSNU-25-30-P-A	1908315	DSNU-25-30-PPV-A
	35	1908308	DSNU-25-35-P-A	1908316	DSNU-25-35-PPV-A
	40	19220	DSNU-25-40-P-A	19245	DSNU-25-40-PPV-A
	50	19221	DSNU-25-50-P-A	19246	DSNU-25-50-PPV-A
	60	1908309	DSNU-25-60-P-A	1908317	DSNU-25-60-PPV-A
	70	1908310	DSNU-25-70-P-A	1908318	DSNU-25-70-PPV-A
	80	19222	DSNU-25-80-P-A	19247	DSNU-25-80-PPV-A
	100	19223	DSNU-25-100-P-A	19248	DSNU-25-100-PPV-A
	125	19224	DSNU-25-125-P-A	19249	DSNU-25-125-PPV-A
	150	1908311	DSNU-25-150-P-A	1908319	DSNU-25-150-PPV-A
	160	19225	DSNU-25-160-P-A	19250	DSNU-25-160-PPV-A
	200	19226	DSNU-25-200-P-A	19251	DSNU-25-200-PPV-A
	250	19227	DSNU-25-250-P-A	19252	DSNU-25-250-PPV-A
300	19228	DSNU-25-300-P-A	19253	DSNU-25-300-PPV-A	
320	34719	DSNU-25-320-P-A	34721	DSNU-25-320-PPV-A	
400	35191	DSNU-25-400-P-A	35193	DSNU-25-400-PPV-A	
500	35192	DSNU-25-500-P-A	35194	DSNU-25-500-PPV-A	

Standard cylinders DSNU, ISO 6432

Technical data

Ordering data			
Piston \varnothing	Stroke	PPS – Pneumatic cushioning, self-adjustable at both ends Without position sensing	
[mm]	[mm]	Part No.	Type
Basic version			
16	40	559234	DSNU-16-40-PPS
	50	559235	DSNU-16-50-PPS
	80	559236	DSNU-16-80-PPS
	100	559237	DSNU-16-100-PPS
	125	559238	DSNU-16-125-PPS
	160	559239	DSNU-16-160-PPS
	200	559240	DSNU-16-200-PPS
20	40	559241	DSNU-20-40-PPS
	50	559242	DSNU-20-50-PPS
	80	559243	DSNU-20-80-PPS
	100	559244	DSNU-20-100-PPS
	125	559245	DSNU-20-125-PPS
	160	559246	DSNU-20-160-PPS
	200	559247	DSNU-20-200-PPS
	250	559248	DSNU-20-250-PPS
	300	559249	DSNU-20-300-PPS
	320	559250	DSNU-20-320-PPS
25	40	559251	DSNU-25-40-PPS
	50	559252	DSNU-25-50-PPS
	80	559253	DSNU-25-80-PPS
	100	559254	DSNU-25-100-PPS
	125	559255	DSNU-25-125-PPS
	160	559256	DSNU-25-160-PPS
	200	559257	DSNU-25-200-PPS
	250	559258	DSNU-25-250-PPS
	300	559259	DSNU-25-300-PPS
	320	559260	DSNU-25-320-PPS
	400	559261	DSNU-25-400-PPS
500	559262	DSNU-25-500-PPS	

Standard cylinders DSNU, ISO 6432

Technical data

Ordering data			
Piston \varnothing [mm]	Stroke [mm]	PPS – Pneumatic cushioning, self-adjustable at both ends A – With position sensing	
		Part No.	Type
Basic version			
16	10	1908274	DSNU-16-10-PPS-A
	15	1908275	DSNU-16-15-PPS-A
	20	1908276	DSNU-16-20-PPS-A
	25	559263	DSNU-16-25-PPS-A
	30	1908277	DSNU-16-30-PPS-A
	35	1908278	DSNU-16-35-PPS-A
	40	559264	DSNU-16-40-PPS-A
	50	559265	DSNU-16-50-PPS-A
	60	1908279	DSNU-16-60-PPS-A
	70	1908280	DSNU-16-70-PPS-A
	80	559266	DSNU-16-80-PPS-A
	100	559267	DSNU-16-100-PPS-A
	125	559268	DSNU-16-125-PPS-A
	150	1908281	DSNU-16-150-PPS-A
160	559269	DSNU-16-160-PPS-A	
200	559270	DSNU-16-200-PPS-A	
20	10	1908297	DSNU-20-10-PPS-A
	15	1908298	DSNU-20-15-PPS-A
	20	1908299	DSNU-20-20-PPS-A
	25	559271	DSNU-20-25-PPS-A
	30	1908300	DSNU-20-30-PPS-A
	35	1908301	DSNU-20-35-PPS-A
	40	559272	DSNU-20-40-PPS-A
	50	559273	DSNU-20-50-PPS-A
	60	1908302	DSNU-20-60-PPS-A
	70	1908303	DSNU-20-70-PPS-A
	80	559274	DSNU-20-80-PPS-A
	100	559275	DSNU-20-100-PPS-A
	125	559276	DSNU-20-125-PPS-A
	150	1908304	DSNU-20-150-PPS-A
	160	559277	DSNU-20-160-PPS-A
	200	559278	DSNU-20-200-PPS-A
	250	559279	DSNU-20-250-PPS-A
300	559280	DSNU-20-300-PPS-A	
320	559281	DSNU-20-320-PPS-A	

Standard cylinders DSNU, ISO 6432

Technical data

Ordering data			
Piston \varnothing	Stroke	PPS – Pneumatic cushioning, self-adjustable at both ends A – With position sensing	
[mm]	[mm]	Part No.	Type
Basic version			
25	10	1908320	DSNU-25-10-PPS-A
	15	1908321	DSNU-25-15-PPS-A
	20	1908322	DSNU-25-20-PPS-A
	25	559282	DSNU-25-25-PPS-A
	30	1908323	DSNU-25-30-PPS-A
	35	1908324	DSNU-25-35-PPS-A
	40	559283	DSNU-25-40-PPS-A
	50	559284	DSNU-25-50-PPS-A
	60	1908325	DSNU-25-60-PPS-A
	70	1908326	DSNU-25-70-PPS-A
	80	559285	DSNU-25-80-PPS-A
	100	559286	DSNU-25-100-PPS-A
	125	559287	DSNU-25-125-PPS-A
	150	1908327	DSNU-25-150-PPS-A
	160	559288	DSNU-25-160-PPS-A
	200	559289	DSNU-25-200-PPS-A
	250	559290	DSNU-25-250-PPS-A
	300	559291	DSNU-25-300-PPS-A
320	559292	DSNU-25-320-PPS-A	
400	559293	DSNU-25-400-PPS-A	
500	559294	DSNU-25-500-PPS-A	

Ordering data			
Piston \varnothing	Stroke	P – Flexible cushioning rings/pads at both ends A – With position sensing	PPV – Pneumatic cushioning, adjustable at both ends A – With position sensing
[mm]	[mm]	Part No.	Type
Variable stroke lengths			
8	10 ... 100	14326	DSNU-8-...-P-A
10	10 ... 100	14325	DSNU-10-...-P-A
12	10 ... 200	14324	DSNU-12-...-P-A
16	10 ... 200	14323	DSNU-16-...-P-A
20	10 ... 320	14328	DSNU-20-...-P-A
25	10 ... 500	14327	DSNU-25-...-P-A
			–
		14320	DSNU-16-...-PPV-A
		14321	DSNU-20-...-PPV-A
		14322	DSNU-25-...-PPV-A

 Note



Additional variants can be configured and ordered via the DSNU product modules → 36.

Standard cylinders DSNUP, ISO 6432

Technical data

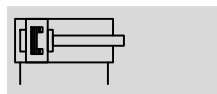
Function



-  - Diameter
16 ... 25 mm
-  - Stroke length
25 ... 100 mm



General technical data			
Piston \varnothing	16	20	25
Pneumatic connection	M5	G $\frac{1}{8}$	G $\frac{1}{8}$
Constructional design	Piston		
	Piston rod		
	Cylinder barrel		
Mode of operation	Double-acting		
Cushioning	Flexible cushioning rings/pads at both ends		
Position sensing	Via proximity sensor		
Type of mounting	Via accessories		
Mounting position	Any		

Operating and environmental conditions	
Operating medium	Compressed air in accordance with ISO 8573-1:2010 [7:4:4]
Note on operating/pilot medium	Operation with lubricated medium possible (in which case lubricated operation will always be required)
Operating pressure ¹⁾ [bar]	1 ... 8
Ambient temperature [°C]	-10 ... +60
Corrosion resistance class CRC ²⁾	2

1) Note operating range of proximity sensors

2) Corrosion resistance class 2 as per Festo standard 940 070

Components subject to moderate corrosion stress. Externally visible parts with primarily decorative surface requirements which are in direct contact with a normal industrial environment or media such as coolants or lubricating agents.

Force [N] and impact energy [J]			
Piston \varnothing	16	20	25
Theoretical force at 6 bar, advancing	121	189	295
Theoretical force at 6 bar, retracting	104	158	247
Impact energy at end positions	0.15	0.20	0.30

Weight [g]			
Piston \varnothing	16	20	25
Product weight with 0 mm stroke	47	83	111
Additional weight per 10 mm stroke	4	6	8
Moving load at 0 mm stroke	23	44	71
Additional load per 10 mm stroke	2	4	6

Standard cylinders DSNUP, ISO 6432

Technical data

Speed without applied load [m/s]			
Piston \varnothing	16	20	25
Advancing			
Minimum	0.015	0.02	0.015
Maximum	2.3	2.3	2.3
Retracting			
Minimum	0.015	0.02	0.015
Maximum	1.9	1.7	2.0

Materials

Sectional view

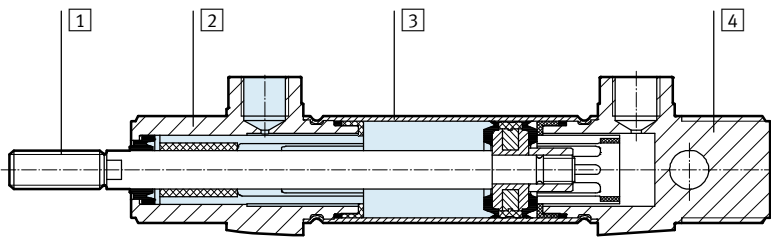

Standard cylinder		
1	Piston rod	High-alloy stainless steel
2	Bearing cap	Polyamide
3	Cylinder barrel	Wrought aluminium alloy
4	End cap	Polyamide
-	Seals	Polyurethane, nitrile rubber
Note on materials		RoHS compliant

Permissible lateral force F_q as a function of stroke length l

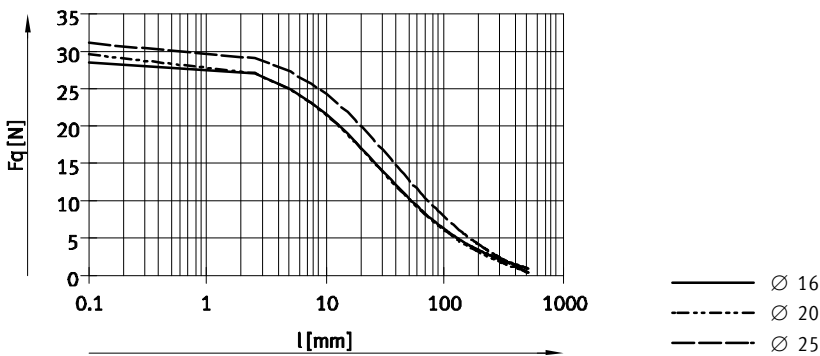

Permissible piston rod displacement f as a function of stroke length l

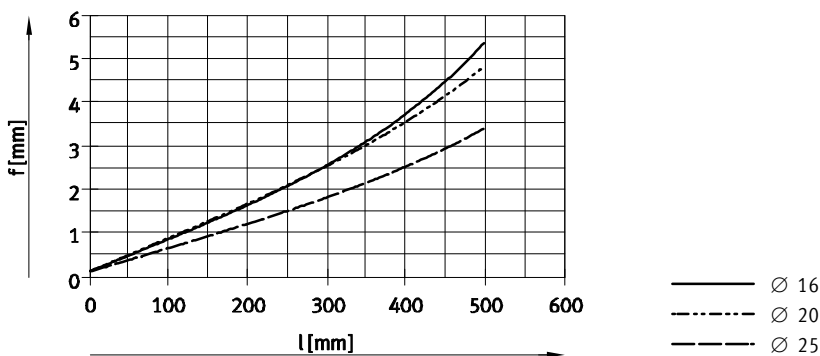

Standard cylinders DSNUP, ISO 6432

Technical data

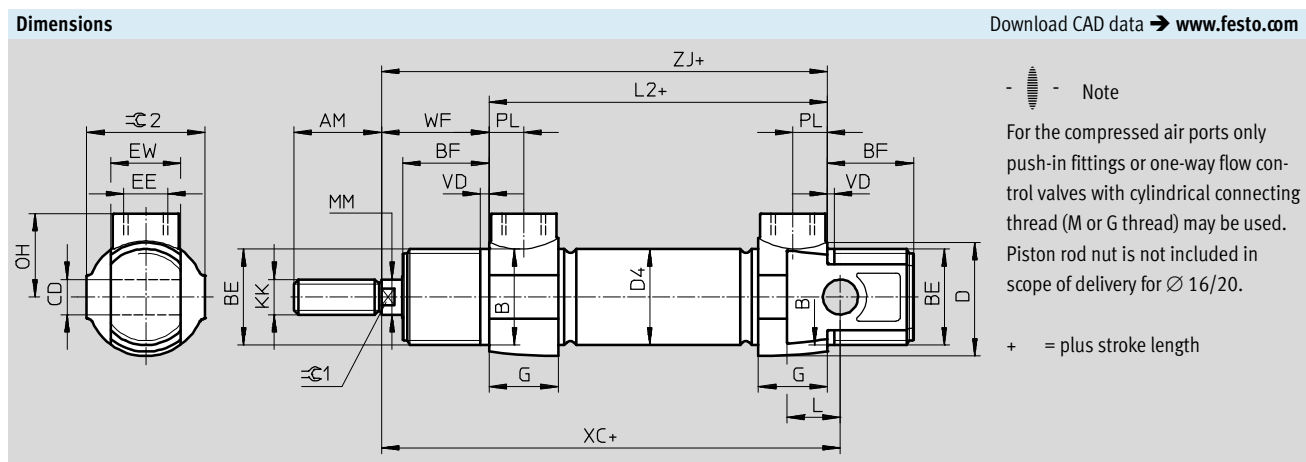

Ø	AM	B	BE	BF	CD	D	D4	EE
[mm]		Ø h9			Ø H9	Ø	Ø	
16	16	16	M16x1.5	17	6	20	18	M5
20	20	22	M22x1.5	20	8	27	22	G $\frac{1}{8}$
25	22	22	M22x1.5	22	8	27	27	G $\frac{1}{8}$

Ø	EW	G	KK	L	L2	MM	OH	PL	VD
[mm]						Ø			
16	12	10	M6	8	56	6	14	4.9	2
20	16	16	M8	12	68	8	19	7.9	2
25	16	16	M10x1.25	12	70	10	19	7.9	2

Ø	WF	XC	ZJ	⌀1	⌀2	Max. tightening torque of thread [Nm]	
						BE ¹⁾	EE
[mm]		±1					
16	22	82	78	5	19	12/8	1.3
20	24	95	92	7	27	22/15	6
25	28	104	98	9	27	22/15	6

1) Bearing cap/end cap

- - Note
 Variable strokes on request.

Ordering data			
Piston Ø	Stroke	Part No.	Type
[mm]	[mm]		
16	25	551 668	DSNUP-16-25-P-A
	50	551 669	DSNUP-16-50-P-A
	100	551 670	DSNUP-16-100-P-A
20	25	551 671	DSNUP-20-25-P-A
	50	551 672	DSNUP-20-50-P-A
	100	551 673	DSNUP-20-100-P-A
25	25	551 674	DSNUP-25-25-P-A
	50	551 675	DSNUP-25-50-P-A
	100	551 676	DSNUP-25-100-P-A

Standard cylinders DSNU-Q, protected against rotation

Technical data

Function

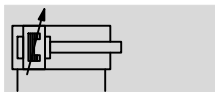
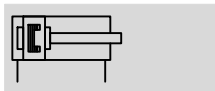

⌀ - Diameter
12 ... 25 mm

┆ - Stroke length
1 ... 250 mm

General technical data				
Piston ⌀	12	16	20	25
Pneumatic connection	M5	M5	G1/8	G1/8
Piston rod thread	M6	M6	M8	M10x1.25
Constructional design	Piston Protected against rotation with square piston rod			
Max. torque at the piston rod [Nm]	0.10	0.10	0.20	0.45
Cushioning	Flexible cushioning rings/pads at both ends		-	
	Adjustable cushioning at both ends			
Cushioning length (PPV) [mm]	-	12	15	17
Position sensing	Via proximity sensor			
Type of mounting	Via accessories			
Mounting position	Any			

⚡ - Note: This product conforms to ISO 1179-1 and to ISO 228-1

Operating conditions				
Piston ⌀	12	16	20	25
Operating medium	Compressed air in accordance with ISO 8573-1:2010 [7:4:4]			
Note on operating/pilot medium	Operation with lubricated medium possible (in which case lubricated operation will always be required)			
Operating pressure [bar]	1.5 ... 10 ¹⁾	1 ... 10		

1) With DSNU-12-...-Q-PPV (pneumatic cushioning adjustable at both ends): 2 ... 10 bar

Ambient conditions		
Standard cylinder	Basic version	R3
Ambient temperature ¹⁾ [°C]	-20 ... +80	
Corrosion resistance class CRC ²⁾	2	3

1) Note operating range of proximity sensors.

2) Corrosion resistance class 2 as per Festo standard 940 070

Components subject to moderate corrosion stress. Externally visible parts with primarily decorative surface requirements which are in direct contact with a normal industrial environment or media such as coolants or lubricating agents.

Corrosion resistance class 3 as per Festo standard 940 070

Components requiring higher corrosion resistance. External visible parts in direct contact with industrial atmospheres or media such as solvents and cleaning agents, with a predominantly functional requirement for the surface.

Standard cylinders DSNU-Q, protected against rotation

Technical data

ATEX ¹⁾	
ATEX category for gas	II 2G
Explosion ignition protection type for gas	c T4
ATEX category for dust	II 2D
Explosion ignition protection type for dust	c 120°C
Explosion-proof temperature rating	-20°C ≤ Ta ≤ +60°C
CE marking (see declaration of conformity)	To EU Explosion Protection Directive (ATEX)

1) Make sure that the accessories are suited for ATEX application.

Forces [N] and impact energy [J]				
Piston Ø	12	16	20	25
Theoretical force at 6 bar, advancing	68	121	189	295
Theoretical force at 6 bar, retracting	51	104	158	247
Max. impact energy at the end positions for flexible cushioning elements ¹⁾	0.07	0.15	0.20	0.30

1) The values are reduced by approx. 50% at an ambient temperature of 80 °C

Weight [g]				
Piston Ø	12	16	20	25
Product weight with 0 mm stroke	80	110	215	275
Additional weight per 10 mm stroke	4.1	4.7	7.1	10.9

Materials

Sectional view

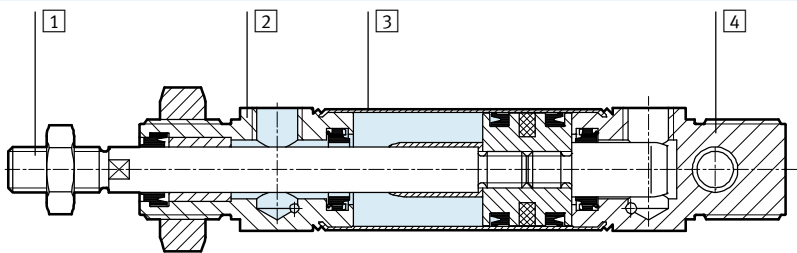

Standard cylinder	
1	Piston rod High-alloy stainless steel
2	Bearing cap Anodised aluminium
3	Cylinder barrel High-alloy stainless steel
4	End cap Anodised aluminium
-	Seals Polyurethane, nitrile rubber

Standard cylinders DSNU-Q, protected against rotation

Technical data

Dimensions Download CAD data → www.festo.com

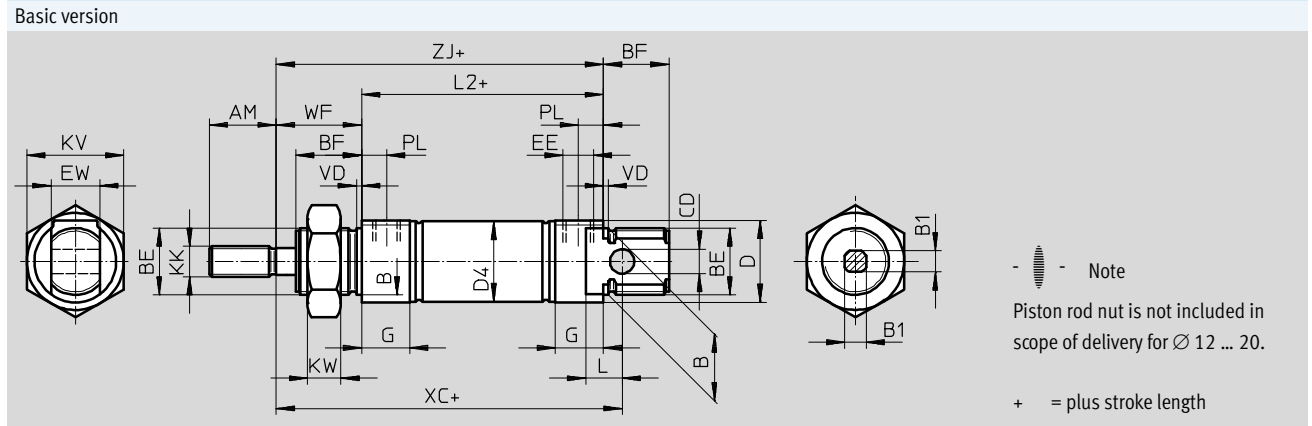

∅	AM	B	B1	BE	BF	CD	D	D4	EE	EW
[mm]		∅ h9	□			∅ H9	∅	∅		
12	16	16	5.5	M16x1.5	17	6	20	13.3	M5	12
16								17.3		
20	22	22	7	M22x1.5	20	8	27	21.3	G1/8	16
25			9		22			26.5		

∅	G	KK	KV	KW	L	L2	PL	VD	WF	XC	ZJ
[mm]										±1	
12	10	M6	24	8	9	50	6	2	22	75	72
16						56				82	78
20	16	M8	32	11	12	68	24		95	92	
25		M10x1.25				69.5	28		104	97.5	

- | - Note: This product conforms to ISO 1179-1 and to ISO 228-1

Standard cylinders DSNU-KP, with clamping unit

Technical data

Function

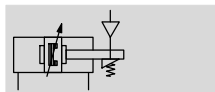
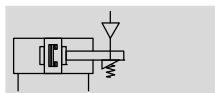

⌀ - Diameter
8 ... 25 mm

l - Stroke length
1 ... 500 mm

⚠ - Note

Additional measures are required for use in safety-related applications; in Europe, for example, the standards listed under the EC Machinery Directive must be observed. Without additional measures in accordance with statutory minimum requirements, the product is not suitable for use in safety-related sections of control systems.



General technical data						
Piston ⌀	8	10	12	16	20	25
Pneumatic connection	M5	M5	M5	M5	G1/8	G1/8
Piston rod thread	M4	M4	M6	M6	M8	M10x1.25
Constructional design	Piston Piston rod Cylinder barrel					
Cushioning	P	Flexible cushioning rings/pads at both ends				
	PPV	-			Pneumatic cushioning, adjustable at both ends	
	PPS	-			Self-adjusting cushioning at both ends	
Cushioning length	PPV [mm]	-		9	12	15
	PPS [mm]	-		12	15	17
Position sensing	Via proximity sensor					
Type of mounting	Via through-holes Via accessories					
Mounting position	Any					
Holding force of the clamping unit [N]	80	80	180	180	350	350
Axial play under load [mm]	0.2		0.3		0.5	
Pneumatic connection of the clamping unit	M5					

⚠ - Note: This product conforms to ISO 1179-1 and to ISO 228-1

Operating conditions						
Piston ⌀	8	10	12	16	20	25
Operating medium	Compressed air in accordance with ISO 8573-1:2010 [7:4:4]					
Note on operating/pilot medium	Operation with lubricated medium possible (in which case lubricated operation will always be required)					
Operating pressure [bar]	3 ... 10					

Ambient conditions		
Standard cylinder	Basic version	R3
Ambient temperature ¹⁾ [°C]	-10 ... +80	
Corrosion resistance class CRC ²⁾	2	3

1) Note operating range of proximity sensors.

2) Corrosion resistance class 2 as per Festo standard 940 070

Components subject to moderate corrosion stress. Externally visible parts with primarily decorative surface requirements which are in direct contact with a normal industrial environment or media such as coolants or lubricating agents.

Corrosion resistance class 3 as per Festo standard 940 070

Components requiring higher corrosion resistance. External visible parts in direct contact with industrial atmospheres or media such as solvents and cleaning agents, with a predominantly functional requirement for the surface.

Standard cylinders DSNU-KP, with clamping unit

Technical data

Force [N] and impact energy [J]						
Piston Ø	8	10	12	16	20	25
Theoretical force at 6 bar, advancing	30	47	68	121	189	295
Theoretical force at 6 bar, retracting	23	40	51	104	158	247
Max. impact energy at the end positions for flexible cushioning elements ¹⁾	0.03	0.05	0.07	0.15	0.20	0.30

1) The values are reduced by approx. 50% at an ambient temperature of 80 °C

Average piston speed v as a function of applied load m in combination with cushioning PPS

Piston Ø 16

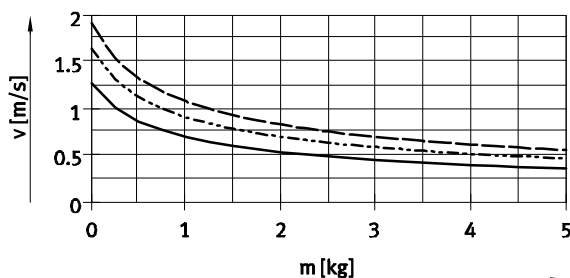

- DSNU-16-50
- - - DSNU-16-100
- · - DSNU-16-200

Piston Ø 20

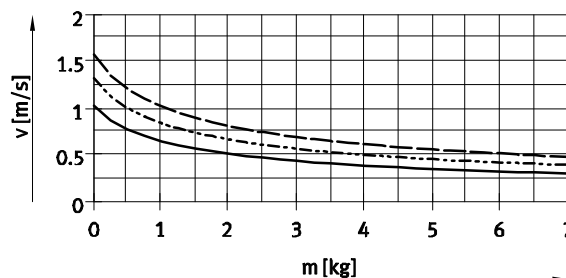

- DSNU-20-50
- - - DSNU-20-100
- · - DSNU-20-200

Piston Ø 25

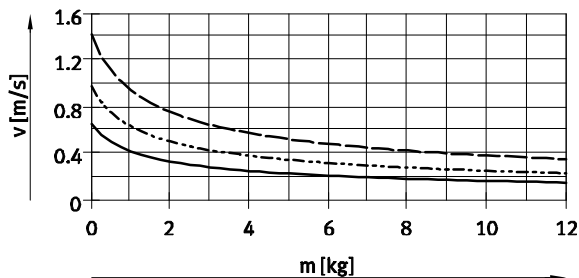

- DSNU-25-50
- - - DSNU-25-100
- · - DSNU-25-200

- · - Note
Average piston speed
= stroke/movement time

- · - Note

Design software for flexible cushioning elements → ProDrive	Additional graphs for PPS cushioning → www.festo.com	Design software for PPV cushioning → ProDrive
--	--	--

Weight [g]						
Piston Ø	8	10	12	16	20	25
Product weight with 0 mm stroke	97.6	100.3	193	207.9	393.8	456
Additional weight per 10 mm stroke	2.4	2.7	4	4.6	7.2	11

Standard cylinders DSNU-KP, with clamping unit

Technical data

Max. lateral force F_q as a function of the projection l

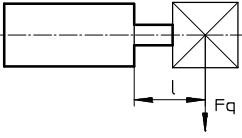

Basic version

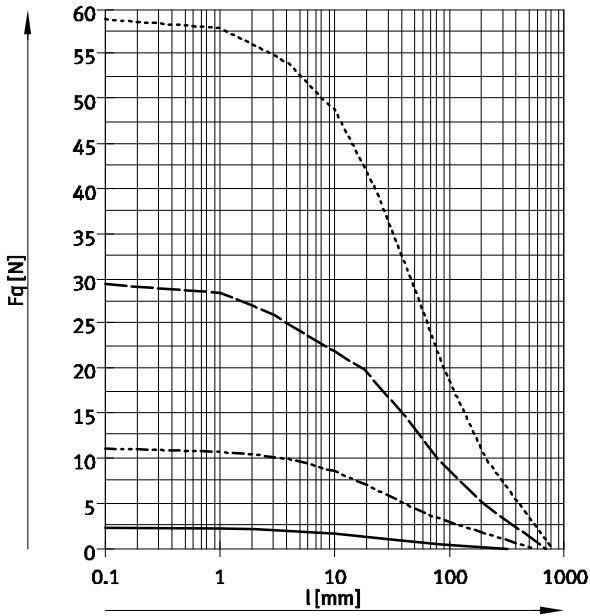

S2 – Through piston rod

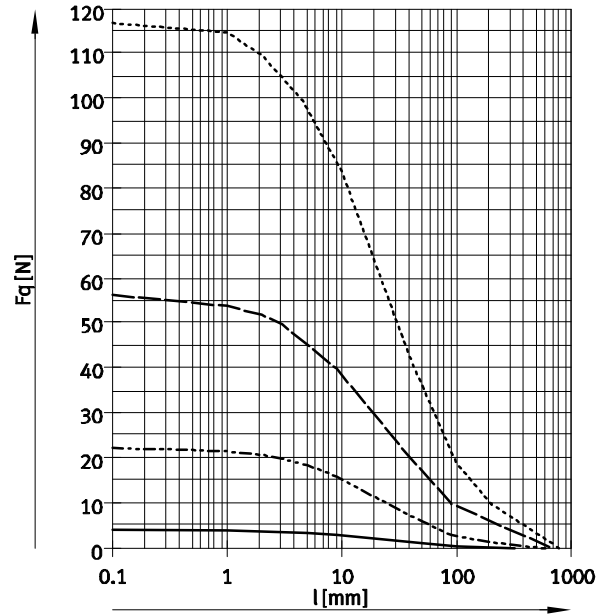

- Ø 8/10
- - - Ø 12/16
- · - · Ø 20
- · · · · Ø 25

Standard cylinders DSNU-KP, with clamping unit

Technical data

Materials

Sectional view

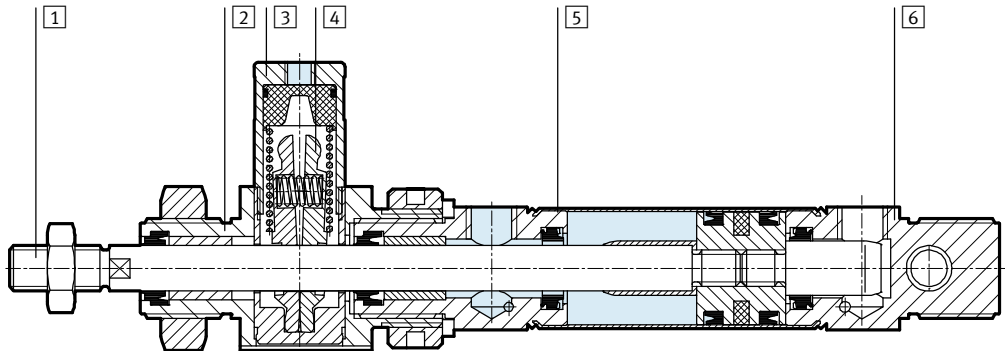

Standard cylinder

1	Piston rod	High-alloy stainless steel
2	Bearing cap	Anodised aluminium
3	Housing, clamping unit	Wrought aluminium alloy
4	Clamping jaws	Brass
5	Cylinder barrel	High-alloy stainless steel
6	End cap	Anodised aluminium
-	Piston, clamping unit	Polyacetate
-	Spring	Spring steel
-	Seals	Polyurethane, nitrile rubber

Standard cylinders DSNU-KP, with clamping unit

Technical data

Dimensions

Download CAD data → www.festo.com

Basic version

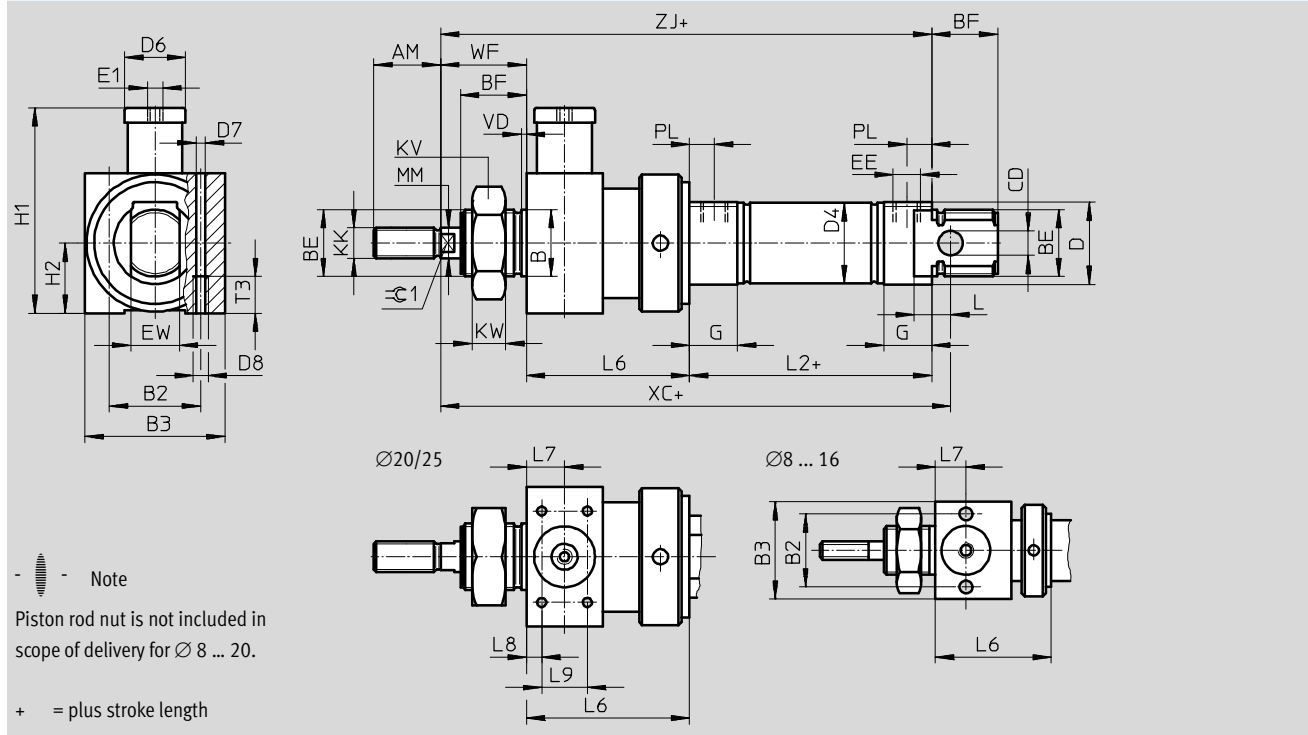

S2 – Through piston rod

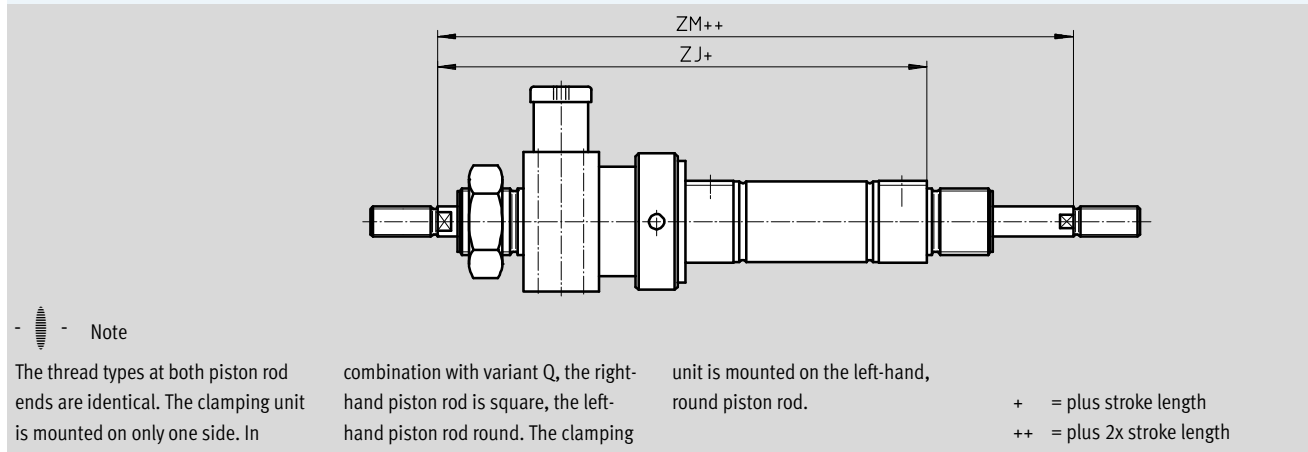

Standard cylinders DSNU-KP, with clamping unit

Technical data

∅ [mm]	AM	B ∅ h9	B2	B3	BE	BF	CD ∅ H9	D ∅	D4 ∅	D6 ∅	D7 ∅	D8
8	12	12	19.5	27	M12x1.25	12	4	15	9.3	12	4.2	M5
10									11.3			
12	16	16	24	32	M16x1.5	17	6	20	13.3	16	4.2	M5
16									17.3			
20	20	22	27	36	M22x1.5	20	8	27	21.3	20	4.2	M5
25	22					22			26.5			

∅ [mm]	E1	EE	EW	G	H1	H2	KK	KV	KW	MM ∅	L	L2
8	M5	M5	8	10	34.5	13.5	M4	19	6	4	6	46
10			12		41	16	M6	24	8	6	9	50
12			16	62.5	18	M8	32	11	8	12	68	
16		G1/8	16	16	62.5	18	M10x1.25	32	11	10	12	69.5
20										10		69.5
25												

∅ [mm]	L6	L7	L8	L9	T3	PL	VD	WF	XC ±1	ZJ	ZM	≈C1
8	29 ±0.65	8	-	-	11	6	2	16	93	91	107	-
10			-	-								-
12	38 ±0.75	10	-	-				11	6	2	22	113
16			-	-	-	-	24	142	139	163	7	
20	47 ±0.75	13	4.5	20	11	6	2	28	152	145.5	173.5	9
25	48 ±0.75											9

• - Note: This product conforms to ISO 1179-1 and to ISO 228-1

Standard cylinders DSNU, ISO 6432

Ordering data – Modular products

Ordering table									
Size	8	10	12	16	20	25	Condi- tions	Code	Enter code
M Module No.	193986	193987	193988	193989	193990	193991			
Function	Standard cylinder, double-acting, based on ISO 6432							DSNU	DSNU
Piston Ø [mm]	8	10	12	16	20	25		-...	
Stroke [mm]	1 ... 100		1 ... 200		1 ... 320	1 ... 500		-...	
Cushioning	Flexible cushioning rings/pads at both ends								-P
	-	-	Pneumatic cushioning, adjustable at both ends				1	-PPV	
	-	-	-	Pneumatic cushioning, self-adjusting at both ends			13	-PPS	
O Position sensing	Via proximity sensor							2	-A
Cylinder end cap	Lateral supply port, end cap							3	-MQ
	Axial supply port, end cap							3	-MA
	With mounting flange at front (direct mounting), bearing cap							4	-MH
↓ Type of piston rod	Through piston rod							5	-S2

- 1 PPV** Not with MA.
In combination with S6, S10, S11 not with piston Ø 12 mm
- 2 A** Minimum stroke: 10 mm
- 3 MQ, MA** Not with S2, S10, S11

- 4 MH** Not with combination S6-R3.
Not with KP, S10, S11
- 5 S2** Not with S10, S11
- 13 PPS** Not with MA, MH, S6, S10, S11
and not with combination MQ-R3

 Note

The bellows kit DADB must not be used in combination with the variant MH.

The running characteristics change slightly when the bellows kit DADB is combined with the variant S10 or S11.

Transfer order code

DSNU - - - - - -

Standard cylinders DSNU, ISO 6432

Ordering data – Modular products

Ordering table										
Size	8	10	12	16	20	25	Condi- tions	Code	Enter code	
↓										
0	Extended male thread [mm]	Extended male piston rod thread 1 ... 15 1 ... 20				1 ... 25	1 ... 35	6	-...K2	
	Shortened male thread [mm]	Shortened male piston rod thread 1 ... 4				1 ... 8	1 ... 10	7	-...K6	
	Female thread	Female piston rod thread - - - - (M4) (M6)						8	-K3	
	Special thread	Piston rod with special thread - - - - - M10							-“...”K5	
	Piston rod extended at one end [mm]	Extended piston rod at one end 1 ... 50 1 ... 100				1 ... 110	1 ... 150		...K8	
	Clamping unit	Attached						9	-KP	
	Temperature resistance	Heat-resistant seals for temperatures up to 120 °C						10	-S6	
	Slow speed (constant motion)	-	-	Slow speed (constant motion at low piston speeds)				11	-S10	
	Low friction	-	-	Low friction				12	-S11	
	Corrosion protection	-	-	High corrosion protection					-R3	
	EU certification	II 2GD						13	-EX4	

- 6 **K2** Not with K3, K6
- 7 **K6** Not with K3
- 8 **K3** Not with K5
- 9 **KP** Not with S6, S10, S11, R3

- 10 **S6** Not with S10, S11
- 11 **S10** Not with S11, R3
- 12 **S11** Not with R3
- 13 **EX4** Not with KP and S6

Transfer order code

- [] - [] - [] - [] - [] - [] - [] - [] - [] - [] - [] - []

Standard cylinders DSNU-Q, protected against rotation

Ordering data – Modular products

Ordering table							
Size	12	16	20	25	Condi- tions	Code	Enter code
M Module No.	193988	193989	193990	193991			
Function	Standard cylinder, double-acting, based on ISO 6432					DSNU	DSNU
Piston Ø [mm]	12	16	20	25		-...	
Stroke [mm]	5 ... 160		5 ... 200		5 ... 250		-...
Cushioning	Flexible cushion- ing rings/pads at both ends	-	-	-		-P	
	-	Pneumatic cushioning, adjustable at both ends				-PPV	
O Position sensing	Via proximity sensor					1	-A
Cylinder end cap	Lateral supply port, end cap					2	-MQ
	Axial supply port, end cap					2	-MA
	- With mounting flange at front (direct mounting), bearing cap					3	-MH
Protection against rotation	Square piston rod						-Q
↓ Type of piston rod	Through piston rod						-S2

1 **A** Minimum stroke: 10 mm
2 **MQ, MA** Not with S2

3 **MH** Not with combination Q-R3

 - Note
 The bellows kit DADB must not be used in combination with the variant Q.

Transfer order code

DSNU - - - - - - - **Q** -

Standard cylinders DSNU-Q, protected against rotation

Ordering data – Modular products

Ordering table							
Size	12	16	20	25	Condi- tions	Code	Enter code
↓ 0	Extended male thread [mm]	Extended male piston rod thread 1 ... 20 1 ... 25 1 ... 35			4	-...K2	
	Shortened male thread [mm]	Shortened male piston rod thread 1 ... 4 1 ... 8 1 ... 10			5	-...K6	
	Female thread	-	(M4)	(M6)	6	-K3	
	Special thread	Piston rod with special thread - - - M10				-“...”K5	
	Piston rod extended at one end [mm]	Extended piston rod at one end 1 ... 100 1 ... 110 1 ... 150				...K8	
	Clamping unit	Attached			7	-KP	
	Corrosion protection	-	High corrosion protection			-R3	
	EU certification	II 2GD			8	-EX4	

- 4 **K2** Not with K3, K6
- 5 **K6** Not with K3
- 6 **K3** Not with K5

- 7 **KP** Only with S2.
Not with R3
- 8 **EX4** Not with KP

Transfer order code

- - - - - - - -

Standard cylinders ESNU, ISO 6432

Technical data

Function

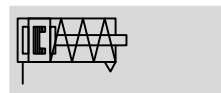

Variants

→43

∅ - Diameter
8 ... 25 mm

┆ - Stroke length
1 ... 50 mm



Basic version



Axial air connection MA

General technical data						
Piston ∅	8	10	12	16	20	25
Pneumatic connection	M5	M5	M5	M5	G1/8	G1/8
Piston rod thread	M4	M4	M6	M6	M8	M10x1.25
Constructional design	Piston					
	Piston rod					
	Cylinder barrel					
Cushioning	Flexible cushioning rings/pads at both ends					
Position sensing	Via proximity sensor					
Type of mounting	Via accessories					
Mounting position	Any					

- Note: This product conforms to ISO 1179-1 and to ISO 228-1

Operating conditions						
Piston ∅	8	10	12	16	20	25
Operating medium	Compressed air in accordance with ISO 8573-1:2010 [7:4:4]					
Note on operating/pilot medium	Operation with lubricated medium possible (in which case lubricated operation will always be required)					
Operating pressure [bar]	1.5 ... 10			1.2 ... 10		

Ambient conditions		
Standard cylinder		
Ambient temperature ¹⁾ [°C]	-20 ... +80	
Corrosion resistance class CRC ²⁾	2	

1) Note operating range of proximity sensors.

2) Corrosion resistance class 2 as per Festo standard 940 070

Components subject to moderate corrosion stress. Externally visible parts with primarily decorative surface requirements which are in direct contact with a normal industrial environment or media such as coolants or lubricating agents.

Standard cylinders ESNU, ISO 6432

Technical data

Force [N] and impact energy [J]						
Piston Ø	8	10	12	16	20	25
Theoretical force at 6 bar, advancing	24	41	61	107	169	270
Spring return force						
10 mm stroke	4.9	4.9	6.3	13.2	18.3	22.9
25 mm stroke	4.1	4.1	5.4	11.9	16.5	21.2
50 mm stroke	2.8	4.8	3.9	9.8	13.6	18.5
Max. impact energy at the end positions ¹⁾	0.03	0.05	0.07	0.15	0.20	0.30

1) The values are reduced by approx. 50% at ambient temperatures of 80 °C

Weight ESNU-... [g]						
Piston Ø	8	10	12	16	20	25
Product weight with 0 mm stroke	35	37.3	75	89.9	186.8	238
Additional weight per 10 mm stroke	2.4	2.7	4	4.6	7.2	11

Weight ESNU-...-MA [g]						
Piston Ø	8	10	12	16	20	25
Product weight with 0 mm stroke	30	33	65	81	167	222
Additional weight per 10 mm stroke	2.4	2.7	4	4.6	7.2	11

Materials

Sectional view

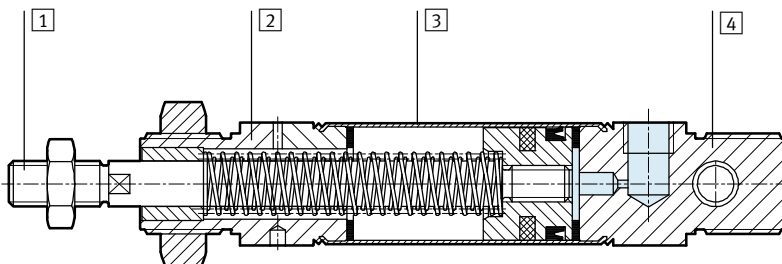

Standard cylinder		
1	Piston rod	High-alloy stainless steel
2	Bearing cap	Anodised aluminium
3	Cylinder barrel	High-alloy stainless steel
4	End cap	Anodised aluminium
-	Seals	Polyurethane, nitrile rubber
-	Spring	Spring steel

Standard cylinders ESNU, ISO 6432

Technical data

Dimensions Download CAD data → www.festo.com
 Basic version

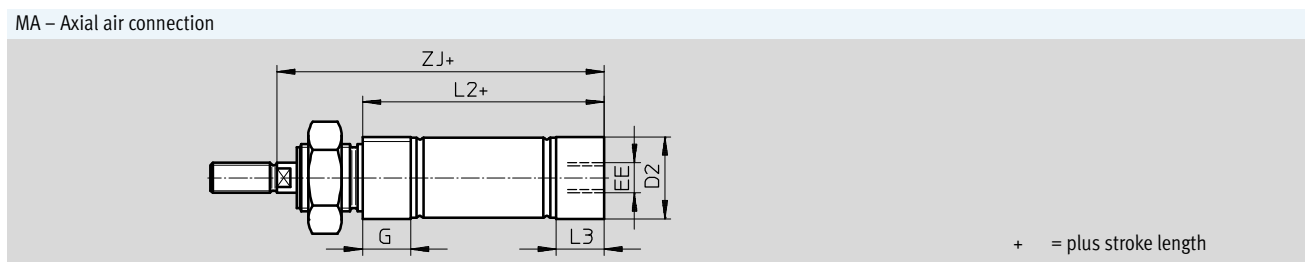
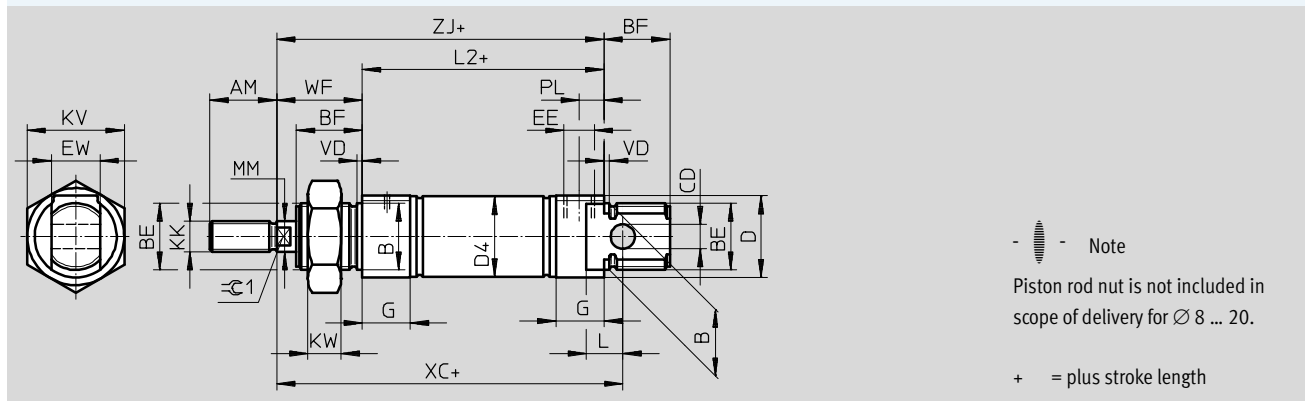

\varnothing	AM	B \varnothing h9	BE	BF	CD \varnothing H9	D \varnothing	D2 \varnothing	D4 \varnothing	EE	EW	G	KK	KV
[mm]													
8	12	12	M12x1.25	12	4	15	10.5	9.3	M5	8	10	M4	19
10							12.5	11.3					
12	16	16	M16x1.5	17	6	20	14.5	13.3	M5	12	10	M6	24
16							17.5	17.3					
20	20	22	M22x1.5	20	8	27	21.7	21.3	G $\frac{1}{8}$	16	16	M8	32
25	22			22			26.7	26.5					

\varnothing	KW	L	L2		L3	MM \varnothing	PL	VD	WF	XC ± 1	ZJ		$\approx \pm 1$
[mm]				-MA								-MA	
8	6	6	46	43.6	7.6	4	6	2	16	64	62	59.6	-
10				43.1	7.1							59.1	
12	8	9	50	47.7	7.7	6	6	2	22	75	72	69.7	5
16				56								53.7	
20	11	12	68	66.5	14.5	8	8.2	2	24	95	92	90.5	7
25				69.5	68.5							14	

Note: This product conforms to ISO 1179-1 and to ISO 228-1

Standard cylinders ESNU, ISO 6432

Technical data

Dimensions

Download CAD data → www.festo.com

K2 – Extended male piston rod thread

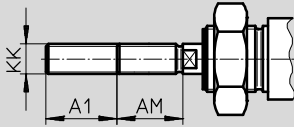

K6 – Shortened male piston rod thread

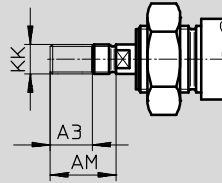

K3 – Female piston rod thread

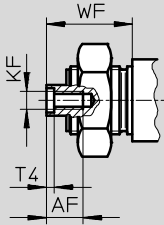

K5 – Special piston rod thread

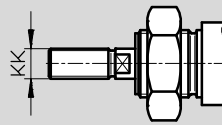

K8 – Extended piston rod

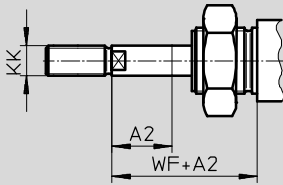

∅ [mm]	A1 max.	A2 max.	A3 max.	AF	AM	KF	KK		T4	WF
							Basic thread	Special thread ¹⁾		
8	15	50	4	–	12	–	M4	–	–	16
10				–		–				
12	–			–						
16	20		8	12	–	16	–	M6	–	22
20					–		–			
25	35		–	–	–	20	M4	M8	2	24
					22	M6	M10x1.25	M10	2.6	28

1) The special threads are only available as male threads. The scope of delivery does not include a hex nut for the piston rod thread.

Standard cylinders ESNU, ISO 6432

Technical data

Ordering data			
Type	Stroke [mm]	Part No.	Type
Basic version			
	Ø 8 mm		
	10	19 254	ESNU-8-10-P-A
	25	19 255	ESNU-8-25-P-A
	50	19 256	ESNU-8-50-P-A
	Ø 10 mm		
	10	19 257	ESNU-10-10-P-A
	25	19 258	ESNU-10-25-P-A
	50	19 259	ESNU-10-50-P-A
	Ø 12 mm		
	10	19 260	ESNU-12-10-P-A
	25	19 261	ESNU-12-25-P-A
	50	19 262	ESNU-12-50-P-A
	Ø 16 mm		
	10	19 263	ESNU-16-10-P-A
	25	19 264	ESNU-16-25-P-A
	50	19 265	ESNU-16-50-P-A
	Ø 20 mm		
	10	19 266	ESNU-20-10-P-A
	25	19 267	ESNU-20-25-P-A
	50	19 268	ESNU-20-50-P-A
	Ø 25 mm		
10	19 269	ESNU-25-10-P-A	
25	19 270	ESNU-25-25-P-A	
50	19 271	ESNU-25-50-P-A	

Standard cylinders ESNU, ISO 6432

Technical data

Ordering data				
Type	∅ [mm]	Stroke [mm]	Part No.	Type
Variable stroke lengths				
	8	1 ... 50	14 119	ESNU-8-...-P-A
	10	1 ... 50	14 118	ESNU-10-...-P-A
	12	1 ... 50	14 317	ESNU-12-...-P-A
	16	1 ... 50	14 316	ESNU-16-...-P-A
	20	1 ... 50	14 319	ESNU-20-...-P-A
	25	1 ... 50	14 318	ESNU-25-...-P-A

Standard cylinders ESNU, ISO 6432

Ordering data – Modular products

Ordering table										
Size	8	10	12	16	20	25	Condi- tions	Code	Enter code	
M Module No.	193996	193997	193998	193999	194000	194001				
Function	Standard cylinder, single-acting pushing, based on ISO 6432							ESNU	ESNU	
Piston Ø [mm]	8	10	12	16	20	25		-...		
Stroke [mm]	1 ... 50								-...	
Cushioning	Flexible cushioning rings/pads at both ends								-P	-P
O Position sensing	Via proximity sensor						1		-A	
↓ End cap	Axial air connection								-MA	

1 A Minimum stroke: 10 mm

Transfer order code

Standard cylinders ESNU, ISO 6432

Ordering data – Modular products

Ordering table										
Size	8	10	12	16	20	25	Condi- tions	Code	Enter code	
↓ 0	Extended male thread [mm]		Extended male piston rod thread 1 ... 15 1 ... 20 1 ... 25 1 ... 35				[2]	-...K2		
	Shortened male thread [mm]		Shortened male piston rod thread 1 ... 4 1 ... 8					-...K6		
	Female thread		Female piston rod thread - - - - (M4) (M6)				[3]	-K3		
	Special thread		Piston rod with special thread - - - - - M10					-...K5		
	Extended piston rod [mm]		Extended piston rod 1 ... 50					...K8		

- [2] **K2** Not with female thread K3, shortened male thread K6
- [3] **K3** Not with special thread K5, shortened male thread K6

Transfer order code

- - - - -

Standard cylinders DSN, ISO 6432

Technical data

Function

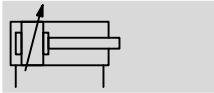
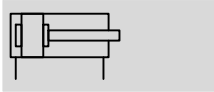

⌀ - Diameter
8 ... 25 mm

— - Stroke length
1 ... 500 mm



General technical data						
Piston Ø	8	10	12	16	20	25
Pneumatic connection	M5	M5	M5	M5	G1/8	G1/8
Piston rod thread	M4	M4	M6	M6	M8	M10x1.25
Constructional design	Piston					
	Piston rod					
	Cylinder barrel					
Cushioning	Flexible cushioning rings/pads at both ends					
	-			Pneumatic cushioning, adjustable at both ends		
Cushioning length (PPV) [mm]	-			14	17	
Type of mounting	Via accessories					
Mounting position	Any					

-||- Note: This product conforms to ISO 1179-1 and to ISO 228-1

Operating conditions						
Piston Ø	8	10	12	16	20	25
Operating medium	Compressed air in accordance with ISO 8573-1:2010 [7:4:4]					
Note on operating/pilot medium	Operation with lubricated medium possible (in which case lubricated operation will always be required)					
Operating pressure [bar]	1.5 ... 10			1 ... 10		

Ambient conditions						
Standard cylinder						
Ambient temperature [°C]	-20 ... +80					
Corrosion resistance class CRC ¹⁾	2					

1) Corrosion resistance class 2 as per Festo standard 940 070
Components subject to moderate corrosion stress. Externally visible parts with primarily decorative surface requirements which are in direct contact with a normal industrial environment or media such as coolants or lubricating agents.

Standard cylinders DSN, ISO 6432

Technical data

Forces [N]						
Piston Ø	8	10	12	16	20	25
Theoretical force at 6 bar, advancing	30	47	68	121	189	295
Theoretical force at 6 bar, retracting	23	40	51	104	158	247

Weights [g]						
Piston Ø	8	10	12	16	20	25
Product weight with 0 mm stroke	40	43	80	96	200	260
Additional weight per 10 mm stroke	2.3	2.5	4.1	4.7	7.1	10.9

Materials

Sectional view

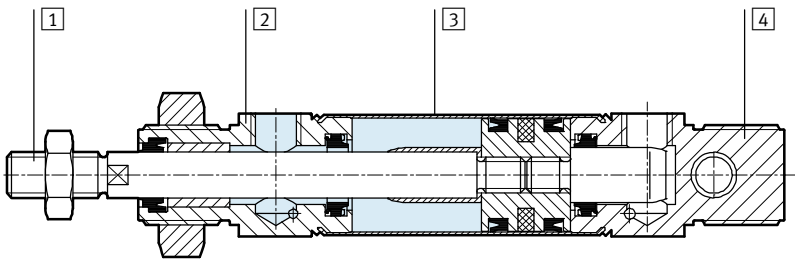

Standard cylinder		
1	Piston rod	High-alloy stainless steel
2	Bearing cap	Anodised aluminium
3	Cylinder barrel	High-alloy stainless steel
4	End cap	Anodised aluminium
-	Seals	Polyurethane, nitrile rubber

Standard cylinders DSN, ISO 6432

Technical data

Dimensions

Download CAD data → www.festo.com

Basic version

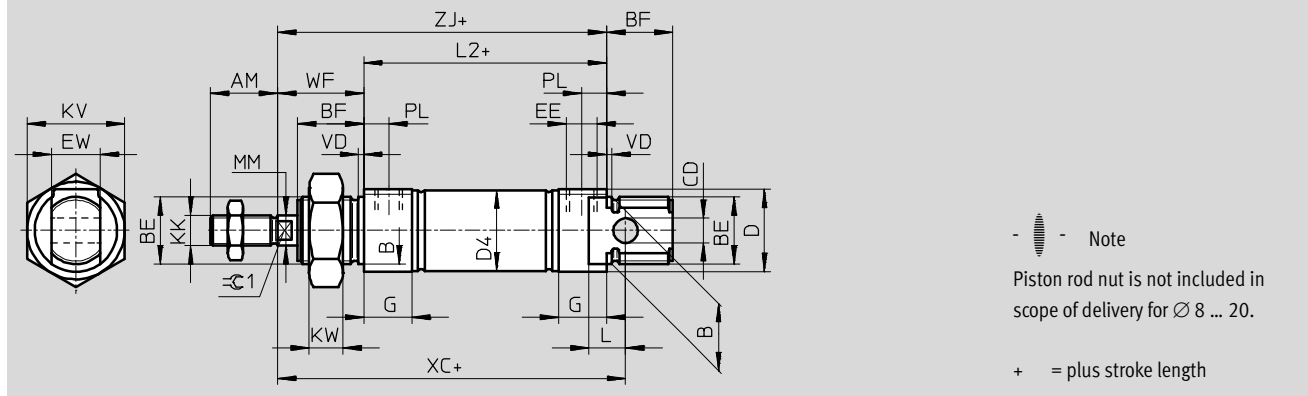

∅	AM	B ∅ h9	BE	BF	CD ∅ H9	D ∅	D4 ∅	EE	EW	G	KK
8	12	12	M12x1.25	12	4	15	9.3	M5	8	10	M4
10							11.3				
12	16	16	M16x1.5	17	6	20	13.3		12	16	M6
16							17.3				
20	22	22	M22x1.5	20	8	27	21.3	16	16	M8	
25				22			22				26.5

∅	KV	KW	L	L2	MM ∅	PL	VD	WF	XC ±1	ZJ	≈C1	
8	19	6	6	46	4	6	2	16	64	62	-	
10				50								
12	24	8	9	56	6			22	75	82	78	5
16				68								
20	32	11	12	69.5	8	8.2	24	95	92	7		
25				69.5							10	28

Note: This product conforms to ISO 1179-1 and to ISO 228-1

Standard cylinders DSN, ISO 6432

Technical data

Ordering data				
Type	Piston Ø [mm]	Stroke [mm]	Flexible cushioning rings/pads at both ends	
			Part No.	Type
Basic version				
	8	10	5 033	DSN-8-10-P
		25	5 034	DSN-8-25-P
		40	5 035	DSN-8-40-P
		50	5 036	DSN-8-50-P
		80	5 037	DSN-8-80-P
		100	5 038	DSN-8-100-P
	10	10	5 040	DSN-10-10-P
		25	5 041	DSN-10-25-P
		40	5 042	DSN-10-40-P
		50	5 043	DSN-10-50-P
		80	5 044	DSN-10-80-P
		100	5 045	DSN-10-100-P
	12	10	5 047	DSN-12-10-P
		25	5 048	DSN-12-25-P
		40	5 049	DSN-12-40-P
		50	5 050	DSN-12-50-P
		80	5 051	DSN-12-80-P
		100	5 052	DSN-12-100-P
		125	8 519	DSN-12-125-P
		160	5 053	DSN-12-160-P
		200	5 054	DSN-12-200-P



Standard cylinders DSN, ISO 6432

Technical data

Ordering data						
Type	Piston Ø [mm]	Stroke [mm]	Flexible cushioning rings/pads at both ends		Pneumatic cushioning, adjustable at both ends	
			Part No.	Type	Part No.	Type
Basic version						
	16	10	5 056	DSN-16-10-P	-	
		25	5 057	DSN-16-25-P	-	
		40	5 058	DSN-16-40-P	14 534	DSN-16-40-PPV
		50	5 059	DSN-16-50-P	14 535	DSN-16-50-PPV
		80	5 060	DSN-16-80-P	14 536	DSN-16-80-PPV
		100	5 061	DSN-16-100-P	14 537	DSN-16-100-PPV
		125	8 520	DSN-16-125-P	14 538	DSN-16-125-PPV
		160	5 062	DSN-16-160-P	14 539	DSN-16-160-PPV
		200	5 063	DSN-16-200-P	14 540	DSN-16-200-PPV
			20	10	5 065	DSN-20-10-P
25	5 066			DSN-20-25-P	-	
40	5 067			DSN-20-40-P	8 743	DSN-20-40-PPV
50	5 068			DSN-20-50-P	8 744	DSN-20-50-PPV
80	5 069			DSN-20-80-P	8 745	DSN-20-80-PPV
100	5 070			DSN-20-100-P	8 746	DSN-20-100-PPV
125	8 521			DSN-20-125-P	8 747	DSN-20-125-PPV
160	5 071			DSN-20-160-P	8 748	DSN-20-160-PPV
200	5 072			DSN-20-200-P	8 749	DSN-20-200-PPV
250	8 522			DSN-20-250-P	8 750	DSN-20-250-PPV
300	5 073			DSN-20-300-P	8 751	DSN-20-300-PPV
320	34 710			DSN-20-320-P	34 712	DSN-20-320-PPV
	25	10	5 075	DSN-25-10-P	-	
		25	5 076	DSN-25-25-P	-	
		40	5 077	DSN-25-40-P	9 666	DSN-25-40-PPV
		50	5 078	DSN-25-50-P	9 667	DSN-25-50-PPV
		80	5 079	DSN-25-80-P	9 668	DSN-25-80-PPV
		100	5 080	DSN-25-100-P	9 669	DSN-25-100-PPV
		125	8 523	DSN-25-125-P	8 531	DSN-25-125-PPV
		160	5 081	DSN-25-160-P	9 670	DSN-25-160-PPV
		200	5 082	DSN-25-200-P	9 671	DSN-25-200-PPV
		250	8 524	DSN-25-250-P	8 532	DSN-25-250-PPV
		300	5 083	DSN-25-300-P	9 672	DSN-25-300-PPV
		320	34 711	DSN-25-320-P	34 713	DSN-25-320-PPV
		400	32 298	DSN-25-400-P	32 300	DSN-25-40-PPV
		500	32 299	DSN-25-500-P	32 301	DSN-25-500-PPV

Standard cylinders DSN, ISO 6432

Technical data

Ordering data						
Type	Piston Ø [mm]	Stroke [mm]	Flexible cushioning rings/pads at both ends		Pneumatic cushioning, adjustable at both ends	
			Part No.	Type	Part No.	Type
Variable stroke lengths						
	8	1 ... 100	5 032	DSN-8-...-P	-	
	10	1 ... 100	5 039	DSN-10-...-P		
	12	1 ... 200	5 046	DSN-12-...-P		
	16	1 ... 200	5 055	DSN-16-...-P		
	20	1 ... 320	5 064	DSN-20-...-P		
	25	1 ... 500	5 074	DSN-25-...-P		
Variable stroke lengths						
	16	1 ... 200	-		14 533	DSN-16-...-PPV
	20	1 ... 320		8 742	DSN-20-...-PPV	
	25	1 ... 500		9 665	DSN-25-...-PPV	

Standard cylinders ESN, ISO 6432

Technical data

Function



⌀ - Diameter
8 ... 25 mm

— - Stroke length
1 ... 50 mm



General technical data						
Piston ⌀	8	10	12	16	20	25
Pneumatic connection	M5	M5	M5	M5	G1/8	G1/8
Piston rod thread	M4	M4	M6	M6	M8	M10x1.25
Constructional design	Piston					
	Piston rod					
	Cylinder barrel					
Cushioning	Flexible cushioning rings/pads at both ends					
Type of mounting	Via accessories					
Mounting position	Any					

— Note: This product conforms to ISO 1179-1 and to ISO 228-1

Operating conditions						
Piston ⌀	8	10	12	16	20	25
Operating medium	Compressed air in accordance with ISO 8573-1:2010 [7:4:4]					
Note on operating/pilot medium	Operation with lubricated medium possible (in which case lubricated operation will always be required)					
Operating pressure [bar]	1.5 ... 10			1.2 ... 10		

Ambient conditions	
Standard cylinder	
Ambient temperature [°C]	-20 ... +80
Corrosion resistance class CRC ¹⁾	2

1) Corrosion resistance class 2 as per Festo standard 940 070
Components subject to moderate corrosion stress. Externally visible parts with primarily decorative surface requirements which are in direct contact with a normal industrial environment or media such as coolants or lubricating agents.

Standard cylinders ESN, ISO 6432

Technical data

Force [N] and impact energy [J]						
Piston Ø	8	10	12	16	20	25
Theoretical force at 6 bar, advancing	24	41	61	107	169	270
Spring return force 10 mm stroke	4.9	4.9	6.3	13.2	18.3	22.9
Spring return force 25 mm stroke	4.1	4.1	5.4	11.9	16.5	21.2
Spring return force 50 mm stroke	2.8	4.8	3.9	9.8	13.6	18.5
Impact energy at end positions	0.03	0.05	0.07	0.15	0.20	0.30

Weight [g]						
Piston Ø	8	10	12	16	20	25
Product weight with 0 mm stroke	40	43	80	96	200	260
Additional weight per 10 mm stroke	2.3	2.5	4.1	4.7	7.1	10.9

Materials

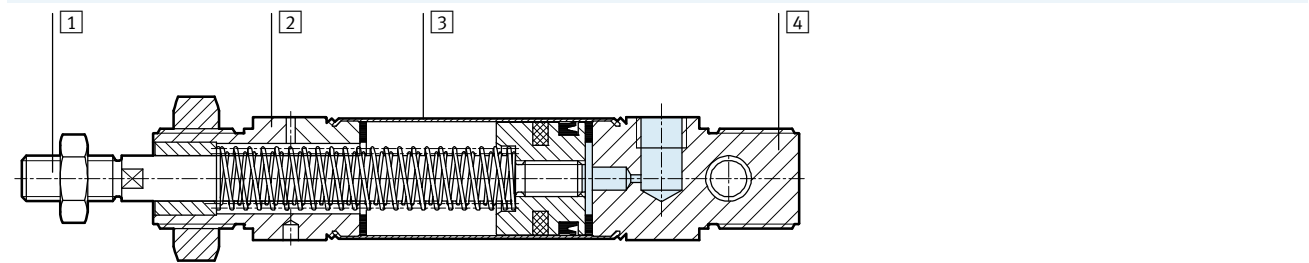

Standard cylinder		
1	Piston rod	High-alloy stainless steel
2	Bearing cap	Anodised aluminium
3	Cylinder barrel	High-alloy stainless steel
4	End cap	Anodised aluminium
-	Seals	Polyurethane, nitrile rubber
-	Spring	Spring steel

Standard cylinders ESN, ISO 6432

Technical data

Dimensions

Download CAD data → www.festo.com

Basic version

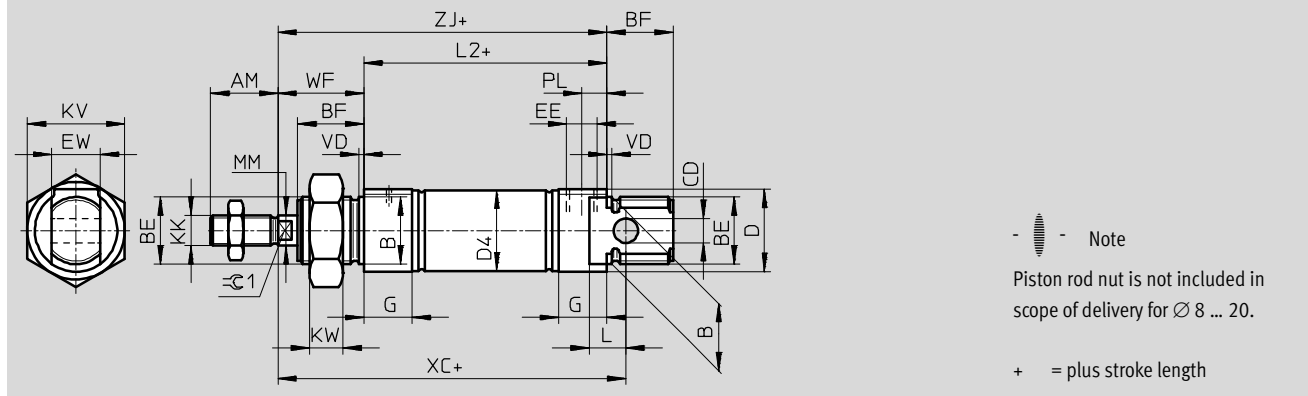

\varnothing	AM	B \varnothing h9	BE	BF	CD \varnothing H9	D \varnothing	D4 \varnothing	EE	EW	G	KK
[mm]											
8	12	12	M12x1.25	12	4	15	9.3	M5	8	10	M4
10							11.3				
12	16	16	M16x1.5	17	6	20	13.3				
16							17.3		M6		
20	20	22	M22x1.5	20	8	27	21.3	G $\frac{1}{8}$	16	16	M8
25	22			22			22				26.5

\varnothing	KV	KW	L	L2	MM \varnothing	PL	VD	WF	XC ± 1	ZJ	$\approx \text{C1}$
[mm]											
8	19	6	6	46	4	6	2	16	64	62	-
10											
12	24	8	9	50	6			22	75	72	5
16				56					82	78	
20	32	11	12	68	8.2	24	95	92	7		
25				69.5			10	28	104	97.5	9

Note: This product conforms to ISO 1179-1 and to ISO 228-1

Standard cylinders ESN, ISO 6432

Technical data

Ordering data			
Type	Stroke [mm]	Part No.	Type
Basic version			
	Ø 8 mm		
	10	5 086	ESN-8-10-P
	25	5 087	ESN-8-25-P
	50	5 088	ESN-8-50-P
	Ø 10 mm		
	10	5 089	ESN-10-10-P
	25	5 090	ESN-10-25-P
	50	5 091	ESN-10-50-P
	Ø 12 mm		
	10	5 092	ESN-12-10-P
	25	5 093	ESN-12-25-P
	50	5 094	ESN-12-50-P
	Ø 16 mm		
	10	5 095	ESN-16-10-P
	25	5 096	ESN-16-25-P
	50	5 097	ESN-16-50-P
	Ø 20 mm		
	10	5 098	ESN-20-10-P
	25	5 099	ESN-20-25-P
	50	5 100	ESN-20-50-P
	Ø 25 mm		
	10	5 101	ESN-25-10-P
	25	5 102	ESN-25-25-P
	50	5 103	ESN-25-50-P

Ordering data			
Type	Ø [mm]	Stroke [mm]	Part No. Type
Variable stroke lengths			
	8	1 ... 50	11 651 ESN-8-...-P
	10	1 ... 50	11 652 ESN-10-...-P
	12	1 ... 50	11 653 ESN-12-...-P
	16	1 ... 50	11 654 ESN-16-...-P
	20	1 ... 50	11 655 ESN-20-...-P
	25	1 ... 50	11 656 ESN-25-...-P

Standard cylinders DSNU/DSNUP/DSN/ESNU/ESN, ISO 6432

Accessories

Foot mounting HBN/CRHBN

Scope of delivery:

HBN/CRHBN-...x1: 1 foot

HBN/CRHBN-...x2: 2 feet and 1 nut

Material:

HBN: Galvanised steel

CRHBN: High-alloy stainless steel

Free of copper and PTFE

RoHS-compliant

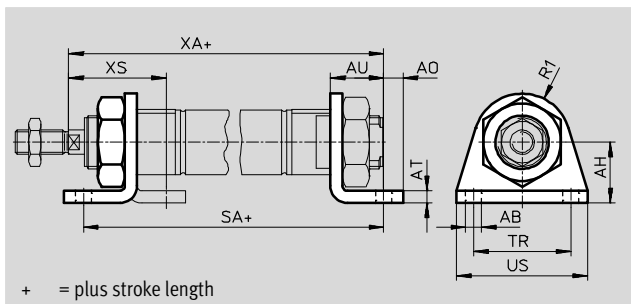

Dimensions and ordering data														
For Ø [mm]	AB Ø	AH	AO	AT	AU	R1	SA		TR	US	XA		XS	
								-KP				-KP		
8, 10	4.5	16	5	3	11	10	68	97	25	35	73	102	24	-
12	5.5	20	6	4	14	13	78	116	32	42	86	124	32	-
16	5.5	20	6	4	14	13	84	122	32	42	92	130	32	-
20	6.6	25	8	5	17	20	102	149	40	54	109	156	36	-
25	6.6	25	8	5	17	20	103.5	151.5	40	54	114.5	162.5	40	-

For Ø [mm]	Basic version				High corrosion protection			
	CRC ¹⁾	Weight [g]	Part No.	Type	CRC ¹⁾	Weight [g]	Part No.	Type
8, 10	2	20	5123	HBN-8/10x1	-	-	-	-
	2	55	5124	HBN-8/10x2	-	-	-	-
12, 16	2	40	5125	HBN-12/16x1	4	40	161866	CRHBN-12/16x1
	2	105	5126	HBN-12/16x2	4	97	162999	CRHBN-12/16x2
20, 25	2	90	5127	HBN-20/25x1	4	55	161867	CRHBN-20/25x1
	2	220	5128	HBN-20/25x2	4	100	162998	CRHBN-20/25x2

1) Corrosion resistance class 2 as per Festo standard 940 070
 Components subject to moderate corrosion stress. Externally visible parts with primarily decorative surface requirements which are in direct contact with a normal industrial environment or media such as coolants or lubricating agents.
 Corrosion resistance class 4 as per Festo standard 940 070
 Components requiring higher corrosion resistance. Parts used with aggressive media, e.g. food or chemical industry. These applications should be supported with special tests with the media if required.

Standard cylinders DSNU/DSNUP/DSN/ESNU/ESN, ISO 6432

Accessories

Flange mounting FBN/CRFBN

Material:

FBN: Galvanised steel

CRFBN: High-alloy stainless steel

Free of copper and PTFE

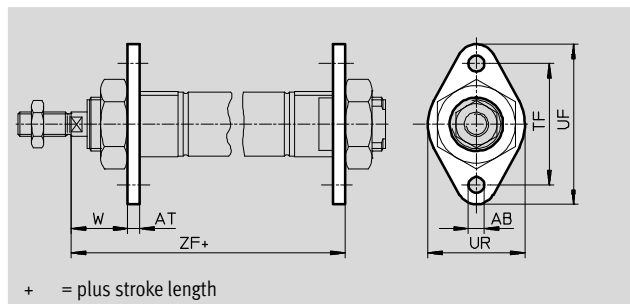

Dimensions and ordering data								
For Ø	AB Ø	AT	TF	UF	UR	W	ZF	
[mm]								-KP
8, 10	4.5	3	30	40	25	13	65	94
12	5.5	4	40	53	30	18	76	114
16	5.5	4	40	53	30	18	82	120
20	6.6	5	50	66	40	19	97	144
25	6.6	5	50	66	40	23	102.5	150.5

For Ø [mm]	Basic version				High corrosion protection			
	CRC ¹⁾	Weight [g]	Part No.	Type	CRC ¹⁾	Weight [g]	Part No.	Type
8, 10	2	12	5129	FBN-8/10	-	-	-	-
12, 16	2	26	5130	FBN-12/16	4	26	161864	CRFBN-12/16
20, 25	2	52	5131	FBN-20/25	4	52	161865	CRFBN-20/25

- 1) Corrosion resistance class 2 as per Festo standard 940 070
 Components subject to moderate corrosion stress. Externally visible parts with primarily decorative surface requirements which are in direct contact with a normal industrial environment or media such as coolants or lubricating agents.
 Corrosion resistance class 4 as per Festo standard 940 070
 Components requiring higher corrosion resistance. Parts used with aggressive media, e.g. food or chemical industry. These applications should be supported with special tests with the media if required.

Swivel mounting SBN

Material:

Mounting ring: Wrought aluminium alloy, anodised

Bearing: Bronze

Screws: Galvanised steel

Bracket: Steel

Cannot be used on the bearing cap in combination with bellows kit DADB.

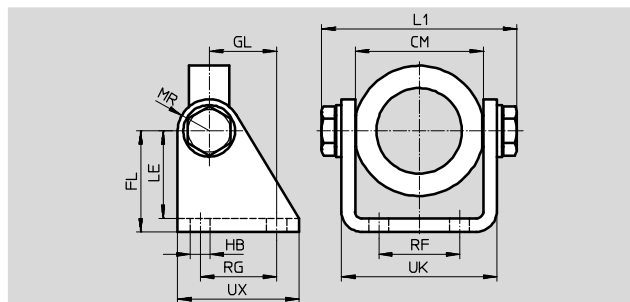
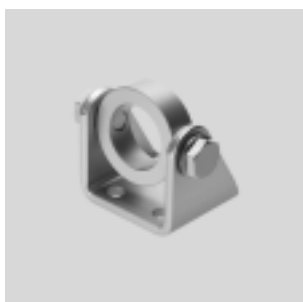

Dimensions and ordering data															
For Ø	CM	FL	GL	HB	L1	LE	MR	RF	RG	UK	UX	CRC ¹⁾	Weight	Part No.	Type
[mm]					max.								[g]		
20/25	38.1+0.4	35	20	7	60.2	31	12	20	24	46.1	40	2	200	539927	SBN-20/25

- 1) Corrosion resistance class 2 as per Festo standard 940 070
 Components subject to moderate corrosion stress. Externally visible parts with primarily decorative surface requirements which are in direct contact with a surrounding industrial atmosphere or media such as cooling or lubricating agents.

Standard cylinders DSNU/DSNUP/DSN/ESNU/ESN, ISO 6432

Accessories

Swivel mounting WBN

Material:

Galvanised steel

Free of copper and PTFE

RoHS-compliant

Cannot be used on the bearing cap in combination with bellows kit DADB.

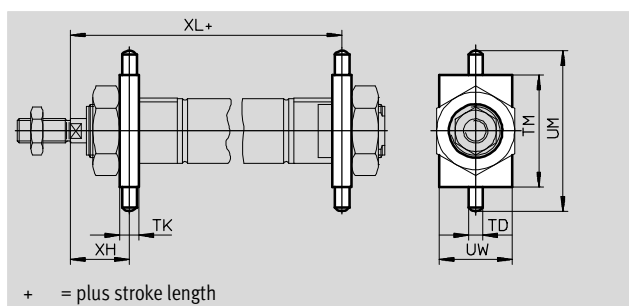

Dimensions and ordering data

For Ø	TD	TK	TM	UM	UW	XH	XL		CRC ¹⁾	Weight	Part No.	Type
[mm]	Ø							-KP		[g]		
8, 10	4	6	26	38	20	13	65	94	2	20	8608	WBN-8/10
12	6	8	38	58	25	18	76	114	2	50	8609	WBN-12/16
16	6	8	38	58	25	18	82	120	2	50	8609	WBN-12/16
20	6	8	46	66	30	20	96	143	2	70	8610	WBN-20/25
25	6	8	46	66	30	24	101.5	149.5	2	70	8610	WBN-20/25

1) Corrosion resistance class 2 as per Festo standard 940 070

Components subject to moderate corrosion stress. Externally visible parts with primarily decorative surface requirements which are in direct contact with a surrounding industrial atmosphere or media such as cooling or lubricating agents.

Clevis foot LBN/CRLBN

Material:

LBN: Galvanised steel

CRLBN: High-alloy stainless steel

Free of copper and PTFE

RoHS-compliant

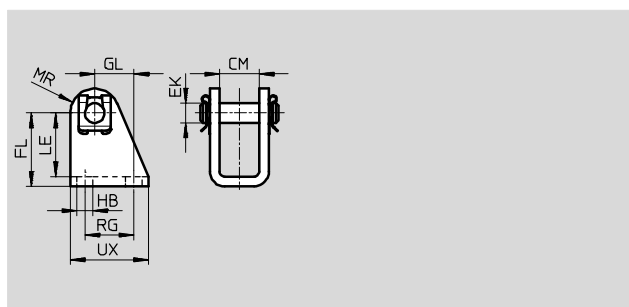

Dimensions and ordering data

For Ø	CM	EK	FL	GL	HB	LE	MR	RG	UX
[mm]		Ø							
8, 10	8.1	4	24 +0.3/-0.2	13.8	4.5	21.5	5	12.5	20
12, 16	12.1	6	27 +0.3/-0.2	13	5.5	24	7	15	25
20, 25	16.1	8	30 +0.4/-0.2	16	6.6	26	10	20	32

For Ø	Basic version				High corrosion protection			
	CRC ¹⁾	Weight [g]	Part No.	Type	CRC ¹⁾	Weight [g]	Part No.	Type
8, 10	2	22	6057	LBN-8/10	–	–	–	–
12, 16	2	40	6058	LBN-12/16	4	55	161862	CRLBN-12/16
20, 25	2	81	6059	LBN-20/25	4	62	161863	CRLBN-20/25

1) Corrosion resistance class 2 as per Festo standard 940 070





Components subject to moderate corrosion stress. Externally visible parts with primarily decorative surface requirements which are in direct contact with a normal industrial environment or media such as coolants or lubricating agents.



Corrosion resistance class 4 as per Festo standard 940 070

Components requiring higher corrosion resistance. Parts used with aggressive media, e.g. food or chemical industry. These applications should be supported with special tests with the media if required.

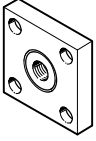
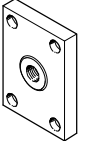
Standard cylinders DSNU/DSNUP/DSN/ESNU/ESN, ISO 6432

Accessories

Ordering data – Piston rod attachments				Technical data → Internet: piston rod attachments					
Designation	For Ø	Part No.	Type	Designation	For Ø	Part No.	Type		
Rod eye SGS				Rod clevis SG					
	8	9253	SGS-M4		8	6532	SG-M4		
	10				10				
	12	9254	SGS-M6		12	3110	SG-M6		
	16				16				
	20				20			3111	SG-M8
	25	9261	25		6144	SG-M10x1,25			
Coupling piece KSG				Coupling piece KSZ					
	8	-			12	36123	KSZ-M6		
	10				16				
	12				36124	KSZ-M8	20	36125	KSZ-M10x1,25
	16						25		
	20						25		
	Self-aligning rod coupler FK				Hex nut MSK				
	8	6528	FK-M4		16	189007	MSK-M16X1,5		
	10				20, 25			189009	MSK-M22X1,5
	12	2061	FK-M6		20	2062	FK-M8		
	16				25			6140	FK-M10x1,25
	20				2062				
	25	6140	FK-M10x1,25						

Ordering data – Piston rod attachments, corrosion resistant				Technical data → Internet: crsg			
Designation	For Ø	Part No.	Type	Designation	For Ø	Part No.	Type
Rod eye CRSGS				Rod clevis CRSG			
	12	195580	CRSGS-M6		12	13567	CRSG-M6
	16				16		
	20	195581	CRSGS-M8		20	13568	CRSG-M8
	25				195582		
Self-aligning rod coupler CRFK							
	25	2305778	CRFK-M10x1,25				

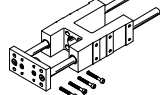
Ordering data – Guide units					Technical data → Internet: feng	
	For Ø	Stroke [mm]	With recirculating ball bearing guide		With plain-bearing guide	
			Part No.	Type	Part No.	Type
	8, 10	1 ... 200	35197	FEN-8/10-...-KF	35196	FEN-8/10-...
	12, 16	1 ... 200	33481	FEN-12/16-...-KF	19168	FEN-12/16-...
	20	2 ... 250	33482	FEN-20-...-KF	19169	FEN-20-...
	25	2 ... 250	33483	FEN-25-...-KF	19170	FEN-25-...

Standard cylinders DSNU/DSNUP/DSN/ESNU/ESN, ISO 6432

Accessories

Bellows kit DADB



General technical data						
Type DADB-S1-			12	16	20	25
Max. stroke range of cylinder ¹⁾	DSNU	[mm]	10 ... 200	10 ... 200	10 ... 320	10 ... 500
	ESNU ²⁾	[mm]	-	-	10 ... 50	10 ... 50
Type of mounting	With threaded pin					
Mounting position	Any					
Resistance to media	Dust, chippings, oil, grease, fuel (→ Internet: Resistance to media)					
Ambient temperature ³⁾		[°C]	-10 ... +80			
Corrosion resistance class CRC ⁴⁾	3					

- 1) In combination with the bellows kit DADB
- 2) Slight change in spring return force
- 3) Note operating range of proximity sensors and cylinder
- 4) Corrosion resistance class 3 as per Festo standard 940 070
Components with heavy corrosion exposure. Externally visible components in direct contact with normal industrial atmosphere or media such as solvents and cleaning agents, where the surface requirement is predominantly functional.

Materials

Sectional view

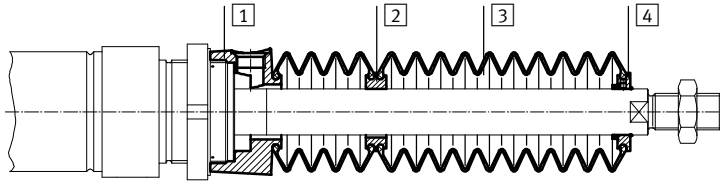

Bellows		
1	Connection	Polyamide
2	Intermediate piece	Polyamide
3	Bellows	Nitrile rubber
4	End piece	Polyamide
-	O-ring	Nitrile rubber
Note on materials		Free of copper and PTFE RoHS compliant

Weight [g]						
Type DADB-S1-			12	16	20	25
Stroke [mm]						
10 ... 50			7	7	20	19
51 ... 100			9	9	32	31
101 ... 150			13	13	45	44
151 ... 200			16	16	58	57
201 ... 250			-	-	73	72
251 ... 300			-	-	85	84
301 ... 350			-	-	100	98
351 ... 400			-	-	-	109
401 ... 450			-	-	-	124
451 ... 500			-	-	-	136

Standard cylinders DSNU/DSNUP/DSN/ESNU/ESN, ISO 6432

Accessories

Speed of travel v as a function of tube length l



The bellows kit is a leak-free system. To prevent unwanted media from being drawn in, the supply and exhaust air must be ducted via a pressure compensation hole in the

connection part [1]. The pressure generated in the bellows kit by the positioning motion is primarily defined by speed of travel

and tubing length. The recommended tubing length based on the travel speed of the drive can be read from the graph.

Advancing

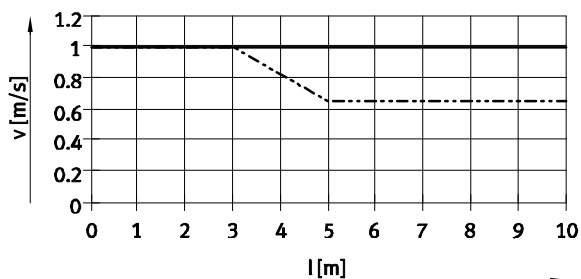

Retracting

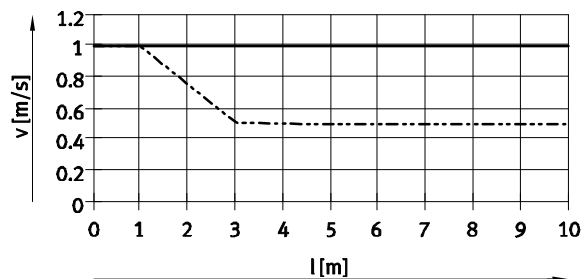

— Ø 12/16
 - - - - - Ø 20/25

Note
 The push-in fittings opposite must be used for the pressure compensation hole.
 Silencers can be used as an alternative. This reduces the travel speed slightly.

Tubing length and push-in fitting for pressure compensation hole		
Ø [mm]	Tubing O.D. [mm]	Push-in fitting
		Part No. Type
12, 16, 20, 25	6	153317 QSM-M5-6-I
		578371 NPQH-DK-M5-Q6-P10
		578335 NPQH-D-M5-Q6-P10
		578359 NPQH-D-M5-S6-P10

Standard cylinders DSNU/DSNUP/DSN/ESNU/ESN, ISO 6432

Accessories

Dimensions Download CAD data → www.festo.com

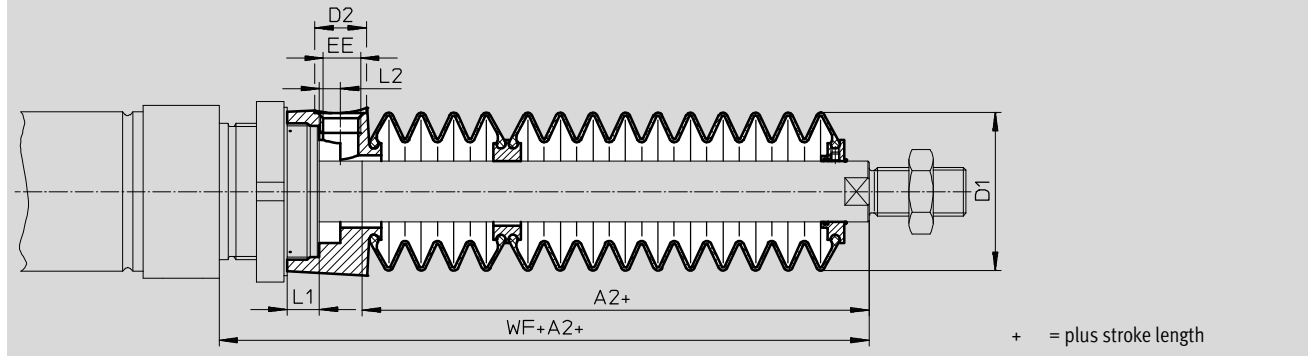

Ø Stroke [mm]	12/16							20						
	A2 ¹⁾	D1 max.	D2	EE	L1	L2	WF+A2	A2 ¹⁾	D1 max.	D2	EE	L1	L2	WF+A2
10 ... 50	23	22	8.5	M5	5	3.2	45	22	29	8.5	M5	4.2	2.7	46
51 ... 100	34						56	34						58
101 ... 150	48						70	47						71
151 ... 200	59						81	60						84
201 ... 250	-						-	75						99
251 ... 300	-						-	86						110
301 ... 350	-						-	101						125
351 ... 400	-						-	-						-
401 ... 450	-						-	-						-
451 ... 500	-						-	-						-

Ø Stroke [mm]	25						
	A2 ¹⁾	D1 max.	D2	EE	L1	L2	WF+A2
10 ... 50	22	29	8.5	M5	4.2	2.7	50
51 ... 100	34						62
101 ... 150	47						75
151 ... 200	60						88
201 ... 250	75						103
251 ... 300	86						114
301 ... 350	101						129
351 ... 400	112						140
401 ... 450	127						155
451 ... 500	138						166

1) The dimension corresponds to the K8 value (extended piston rod) of the drive

Standard cylinders DSNU/DSNUP/DSN/ESNU/ESN, ISO 6432

Accessories

Ordering data – Bellows kit

An extended piston rod (order code K8) is required when using a bellows kit
 → Ordering data – Modular products.

The necessary dimensions for K8 as a function of piston diameter and cylinder stroke as well as the corresponding bellows kit are indicated in the table below:

Order example:

Selected standard cylinder:

DSNU-25-320-PPV-A-MQ-...

The dimension for the corresponding K8 value (see table):
 101 mm

Complete type code for standard cylinder:

DSNU-25-320-PPV-A-MQ-...-101K8

The corresponding bellows kit:

DADB-S1-25-S301-350

Cylinder data			Bellows kit		Cylinder data			Bellows kit	
∅	Stroke	Dimension for K8	Part No.	Type	∅	Stroke	Dimension for K8	Part No.	Type
[mm]	[mm]	[mm]			[mm]	[mm]	[mm]		
12	10 ... 50	23	553391	DADB-S1-12-S10-50	16	10 ... 50	23	553399	DADB-S1-16-S10-50
	51 ... 100	34	553393	DADB-S1-12-S51-100		51 ... 100	34	553401	DADB-S1-16-S51-100
	101 ... 150	48	553395	DADB-S1-12-S101-150		101 ... 150	48	553403	DADB-S1-16-S101-150
	151 ... 200	59	553397	DADB-S1-12-S151-200		151 ... 200	59	553405	DADB-S1-16-S151-200
20	10 ... 50	22	553407	DADB-S1-20-S10-50	25	10 ... 50	22	553421	DADB-S1-25-S10-50
	51 ... 100	34	553409	DADB-S1-20-S51-100		51 ... 100	34	553423	DADB-S1-25-S51-100
	101 ... 150	47	553411	DADB-S1-20-S101-150		101 ... 150	47	553425	DADB-S1-25-S101-150
	151 ... 200	60	553413	DADB-S1-20-S151-200		151 ... 200	60	553427	DADB-S1-25-S151-200
	201 ... 250	75	553415	DADB-S1-20-S201-250		201 ... 250	75	553429	DADB-S1-25-S201-250
	251 ... 300	86	553417	DADB-S1-20-S251-300		251 ... 300	86	553431	DADB-S1-25-S251-300
	301 ... 320	101	553419	DADB-S1-20-S301-350		301 ... 350	101	553433	DADB-S1-25-S301-350
				351 ... 400		112	553435	DADB-S1-25-S351-400	
				401 ... 450		127	553437	DADB-S1-25-S401-450	
				451 ... 500		138	553439	DADB-S1-25-S451-500	





Note

Can only be used with piston ∅ 20 and 25 of the single-acting standard cylinder ESNU.



Standard cylinders DSNU/DSNUP/DSN/ESNU/ESN, ISO 6432

Accessories

Ordering data – Proximity sensors, round design, magneto-resistive							Technical data → Internet: smto	
Assembly	Switching output	Electrical connection		Cable length [m]	Connection direction	Part No.	Type	
		Cable	Plug M8					
N/O contact								
	Via accessories	PNP	3-wire	–	2.5	In-line	152836	SMTO-4U-PS-K-LED-24
			–	3-pin	–	In-line	152742	SMTO-4U-PS-S-LED-24
		NPN	3-wire	–	2.5	In-line	152837	SMTO-4U-NS-K-LED-24
			–	3-pin	–	In-line	152743	SMTO-4U-NS-S-LED-24

Ordering data – Proximity sensors, round design, magnetic reed							Technical data → Internet: smeo	
Assembly	Electrical connection	Cable length [m]	Connection direction	Part No.	Type			
						Cable	Plug M8	
N/O contact								
	Via accessories	3-wire	–	2.5	In-line	36198	SMEO-4U-K-LED-24	
		–	–	5	In-line	175401	SMEO-4U-K5-LED-24	
		–	3-pin	–	In-line	151526	SMEO-4U-S-LED-24-B	



Ordering data – Proximity sensors, round design, magnetic reed, corrosion resistant							Technical data → Internet: crsmeo	
Assembly	Electrical connection	Cable length [m]	Connection direction	Part No.	Type			
						Cable	Plug M8	
N/O contact								
	Via accessories	3-wire	–	2.5	In-line	161775	CRSMEO-4-K-LED-24	

Ordering data – Mounting kits for proximity sensors SMEO/SMTO/CRSMEO							Technical data → Internet: smbr	
Designation	For Ø	Part No.	Type	Designation	For Ø	Part No.	Type	
Mounting kit SMBR				Mounting kit CRSMBR, corrosion resistant				
	8	19272	SMBR-8		8	–	–	
	10	19273	SMBR-10		10	–	–	
	12	19274	SMBR-12		12	164581	CRSMBR-12	
	16	19275	SMBR-16		16	164582	CRSMBR-16	
	20	19276	SMBR-20		20	164583	CRSMBR-20	
	25	19277	SMBR-25		25	164584	CRSMBR-25	

Standard cylinders DSNU/DSNUP/DSN/ESNU/ESN, ISO 6432

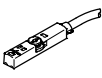
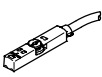
Accessories

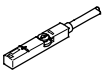
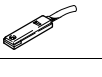
Ordering data – Proximity sensors for T-slot, magneto-resistive						Technical data → Internet: smt	
	Type of mounting	Switch output	Electrical connection	Cable length [m]	Part No.	Type	
N/O contact							
	Insertable in the slot from above, flush with cylinder profile, short design	PNP	Cable, 3-wire	2.5	574335	SMT-8M-A-PS-24V-E-2,5-OE	
			Plug M8x1, 3-pin	0.3	574334	SMT-8M-A-PS-24V-E-0,3-M8D	
			Plug M12x1, 3-pin	0.3	574337	SMT-8M-A-PS-24V-E-0,3-M12	
		NPN	Cable, 3-wire	2.5	574338	SMT-8M-A-NS-24V-E-2,5-OE	
			Plug M8x1, 3-pin	0.3	574339	SMT-8M-A-NS-24V-E-0,3-M8D	
N/C contact							
	Insertable in the slot from above, flush with cylinder profile, short design	PNP	Cable, 3-wire	7.5	574340	SMT-8M-A-PO-24V-E-7,5-OE	



Ordering data – Proximity sensors for T-slot, magnetic reed						Technical data → Internet: sme		
	Type of mounting	Switching output	Electrical connection	Cable length [m]	Part No.	Type		
N/O contact								
	Insertable in the slot from above, flush with the cylinder profile	Contacting	Cable, 3-wire	2.5	543862	SME-8M-DS-24V-K-2,5-OE		
				5.0	543863	SME-8M-DS-24V-K-5,0-OE		
			Plug M8x1, 3-pin	Cable, 2-wire	2.5	543872	SME-8M-ZS-24V-K-2,5-OE	
				0.3	543861	SME-8M-DS-24V-K-0,3-M8D		
	Insertable in the slot lengthwise, flush with the cylinder profile	Contacting	Cable, 3-wire	2.5	150855	SME-8-K-LED-24		
			Plug M8x1, 3-pin	0.3	150857	SME-8-S-LED-24		
N/C contact								
	Insertable in the slot lengthwise, flush with the cylinder profile	Contacting	Cable, 3-wire	7.5	160251	SME-8-O-K-LED-24		

Ordering data – Mounting kits for proximity sensors SME/SMT-8					Technical data → Internet: smbr	
Designation	For Ø				Part No.	Type
Mounting kit SMBR-8						
	8				175091	SMBR-8-8
	10				175092	SMBR-8-10
	12				175093	SMBR-8-12
	16				175094	SMBR-8-16
	20				175095	SMBR-8-20
	25				175096	SMBR-8-25



Standard cylinders DSNU/DSNUP/DSN/ESNU/ESN, ISO 6432

Accessories

Ordering data – Proximity sensors for slot type 10 (C-slot), magneto-resistive						Technical data → Internet: smt
	Type of mounting	Switching output	Electrical connection, connection direction	Cable length [m]	Part No.	Type
N/O contact						
	Insertable in the slot from above	PNP	Cable, 3-wire, in-line	2.5	551373	SMT-10M-PS-24V-E-2,5-L-OE
			Plug M8x1, 3-pin, in-line	0.3	551375	SMT-10M-PS-24V-E-0,3-L-M8D
			Plug M8x1, 3-pin, angled	0.3	551376	SMT-10M-PS-24V-E-0,3-Q-M8D

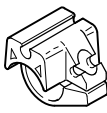

Ordering data – Proximity sensors for C-slot, magnetic reed						Technical data → Internet: sme
	Type of mounting	Switching output	Electrical connection, connection direction	Cable length [m]	Part No.	Type
N/O contact						
	Insertable in the slot from above	Contacting	Plug M8x1, 3-pin, in-line	0.3	551367	SME-10M-DS-24V-E-0,3-L-M8D
			Cable, 3-wire, in-line	2.5	551365	SME-10M-DS-24V-E-2,5-L-OE
			Cable, 2-wire, in-line	2.5	551369	SME-10M-ZS-24V-E-2,5-L-OE
	Insertable in slot lengthwise	Contacting	Plug M8x1, 3-pin, in-line	0.3	173212	SME-10-SL-LED-24
			Cable, 3-wire, in-line	2.5	173210	SME-10-KL-LED-24

Ordering data – Mounting kits for proximity sensors SME/SMT-10					Technical data → Internet: smbr
Designation	For Ø		Part No.	Type	
Mounting kit SMBR-10					
	8		175101	SMBR-10-8	
	10		173227	SMBR-10-10	
	12		175102	SMBR-10-12	
	16		173228	SMBR-10-16	
	20		175103	SMBR-10-20	
	25		175104	SMBR-10-25	

Ordering data – Connecting cables					Technical data → Internet: nebu
	Electrical connection, left	Electrical connection, right	Cable length [m]	Part No.	Type
	Straight socket, M8x1, 3-pin	Cable, open end, 3-wire	2.5	541333	NEBU-M8G3-K-2.5-LE3
			5	541334	NEBU-M8G3-K-5-LE3
	Straight socket, M12x1, 5-pin	Cable, open end, 3-wire	2.5	541363	NEBU-M12G5-K-2.5-LE3
			5	541364	NEBU-M12G5-K-5-LE3
	Angled socket, M8x1, 3-pin	Cable, open end, 3-wire	2.5	541338	NEBU-M8W3-K-2.5-LE3
			5	541341	NEBU-M8W3-K-5-LE3
	Angled socket, M12x1, 5-pin	Cable, open end, 3-wire	2.5	541367	NEBU-M12W5-K-2.5-LE3
			5	541370	NEBU-M12W5-K-5-LE3

Standard cylinders DSNU/DSNUP/DSN/ESNU/ESN, ISO 6432

Accessories

Ordering data – One-way flow control valves				Technical data → Internet: grl			
	Port	For tubing O.D.	Material	Part No.	Type		
	Thread						
For exhaust air							
	M5	3	Metal design	193137	GRLA-M5-QS-3-D		
		4		193138	GRLA-M5-QS-4-D		
		6		193139	GRLA-M5-QS-6-D		
	G1/8	3		193142	GRLA-1/8-QS-3-D		
		4		193143	GRLA-1/8-QS-4-D		
		6		193144	GRLA-1/8-QS-6-D		
		8		193145	GRLA-1/8-QS-8-D		
	For supply air						
		M5		3	Metal design	193153	GRLZ-M5-QS-3-D
4			193154	GRLZ-M5-QS-4-D			
6			193155	GRLZ-M5-QS-6-D			
G1/8		3	193156	GRLZ-1/8-QS-3-D			
		4	193157	GRLZ-1/8-QS-4-D			
		6	193158	GRLZ-1/8-QS-6-D			
		8	193159	GRLZ-1/8-QS-8-D			

Ordering data – One-way flow control valves, corrosion resistant				Technical data → Internet: crgria	
	Port	For push-in fitting	Material	Part No.	Type
	Thread				
For exhaust air					
	M5	CRQS/CRQSL/CRQST	Electrolytically polished stainless steel casting	161403	CRGRLA-M5-B
	G1/8			161404	CRGRLA-1/8-B

 Note

Only push-in fittings or one-way flow control valves with cylindrical connecting thread (M or G thread) may be used for the compressed air ports in conjunction with the DSNUP.