

## Mini guided cylinders DFC

**FESTO**

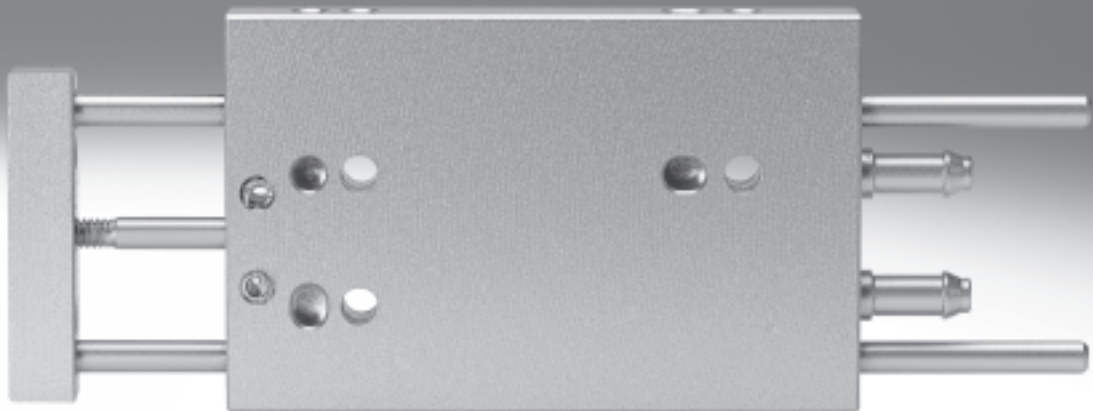

# Mini guided cylinders DFC

Product range and peripherals overview

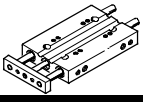
Function	Version	Type	Piston Ø [mm]	Stroke [mm]
Double-acting		DFC	4	5, 10, 15, 20
			6	5, 10, 15, 20, 25, 30
			10	5, 10, 15, 20, 25, 30

Piston Ø 4 mm

Piston Ø 6, 10 mm

Integrated push-in/threaded fitting

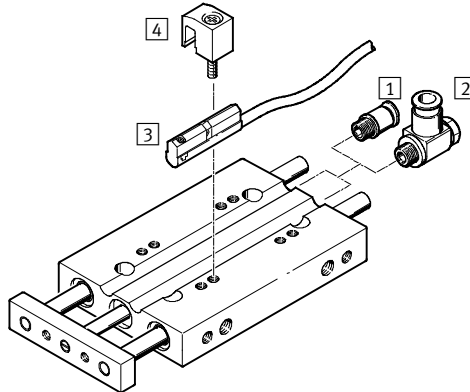
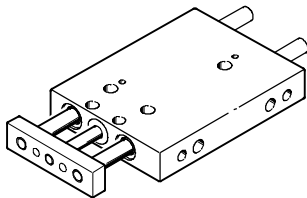

Accessories		Brief description	Piston Ø 4 mm	Piston Ø 6 mm	Piston Ø 10 mm	→ Page/Internet
1	Push-in/threaded fitting QSM	For connecting compressed air tubing with standard O.D.	-	■	■	quick star
2	One-way flow control valve GRLZ	For speed regulation	-	-	■	10
3	Proximity sensor SME/SMT-10	-	-	■	■	10
4	Sensor bracket	Included in the scope of delivery of the mini slide unit	-	■	■	-

## Mounting options

Horizontal mounting from above

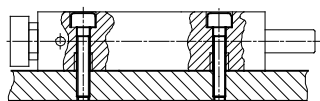

Horizontal mounting from below

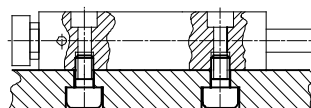

Side mounting from below

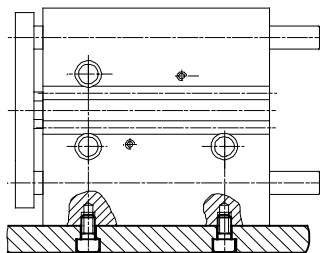

Yoke mounting

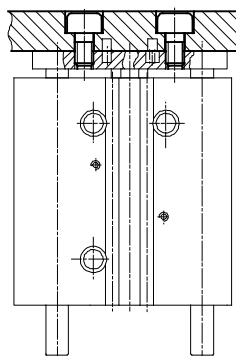

# Mini guided cylinders DFC

Type code

		DFC	-	6	-	20	-	P	-	A	-	GF
<b>Type</b>												
Double-acting												
DFC	Mini guided cylinder											
<b>Piston Ø [mm]</b>												
<b>Stroke [mm]</b>												
<b>Cushioning</b>												
P	Flexible cushioning rings/plates at both ends											
<b>Position sensing</b>												
	No position sensing											
A	For proximity sensing											
<b>Guide</b>												
GF	Plain-bearing guide											
KF	Recirculating ball bearing guide											

# Mini guided cylinders DFC

Technical data

Function

**DFC-...**  
without end-position sensing

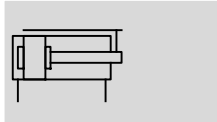

**DFC-...-A-...**

with end position sensing

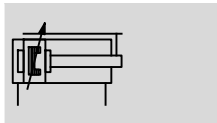

- - Diameter  
4, 6, 10 mm
- - Stroke length  
5 ... 30 mm
- - [www.festo.com](http://www.festo.com)

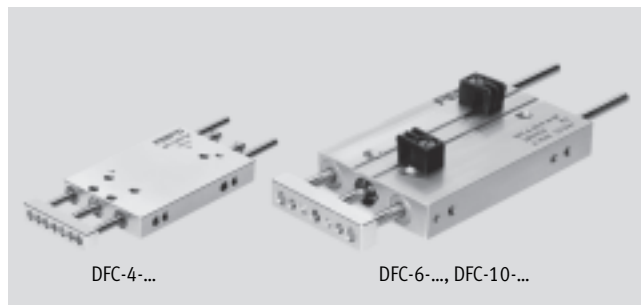

General technical data			
Piston Ø	4	6	10
Pneumatic connection	Barbed fitting PK-3 for 3 mm plastic tubing	M3	M5
Operating medium	Compressed air in accordance with ISO 8573-1:2010 [7:4:4]		
Note on operating/pilot medium	Operation with lubricated medium possible (in which case lubricated operation will always be required)		
Operating pressure [bar]	3.5 ... 7.0	1.5 ... 10.0	1.0 ... 10.0
Constructional design	Piston		
	Piston rod		
	Guide rods with yoke		
Cushioning	Flexible cushioning rings/plates at both ends		
Position sensing	-	For proximity sensing	
Type of mounting	Via through holes		
	Via female thread		
Mounting position	Any		
Protection against torsion/guide	Guide rod with yoke with plain-bearing guide		Guide rod with yoke with plain-bearing or ball bearing guide

Ambient conditions		
Variant	Plain-bearing guide GF	Recirculating ball bearing guide KF
Ambient temperature <sup>1)</sup> [°C]	-5 ... +60	
Corrosion resistance class CRC <sup>2)</sup>	2	-

1) Note operating range of proximity sensors.

2) Corrosion resistance class 2 according to Festo standard 940 070

Components requiring moderate corrosion resistance. Externally visible parts with primarily decorative surface requirements which are in direct contact with a surrounding industrial atmosphere or media such as cooling or lubricating agents.

Speeds [m/s] at maximum stroke length			
Piston Ø	4	6	10
Maximum speed	1.0	1.0	1.0
Minimum speed	0.1	0.1	0.1

Forces [N]			
Piston Ø	4	6	10
Theoretical force at 6 bar, advancing	7.5	17	47
Theoretical force at 6 bar, retracting	5.5	12.5	35

## Mini guided cylinders DFC

Technical data

Impact energy [J]			
Piston Ø	4	6	10
Max. impact energy at end positions	0.006	0.008	0.05

Permissible impact velocity:

$$v_{perm.} = \sqrt{\frac{2 \times E_{perm.}}{m_{dead} + m_{load}}}$$

$v_{perm.}$  Permissible impact velocity

$E_{perm.}$  Max. impact energy

$m_{dead}$  Moving load (drive)

$m_{load}$  Moving work load



Note

These specifications represent the maximum values which can be reached. Note the maximum permitted impact energy.

Maximum permissible load:

$$m_{load} = \frac{2 \times E_{perm.}}{v^2} - m_{dead}$$

Maximum permissible load m as a function of the impact speed v

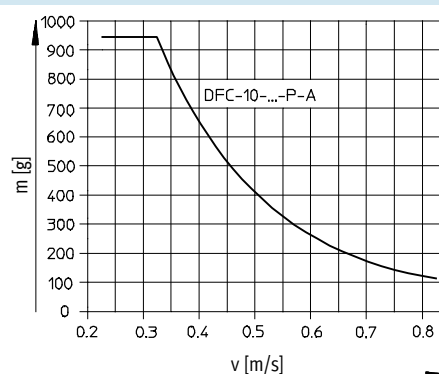
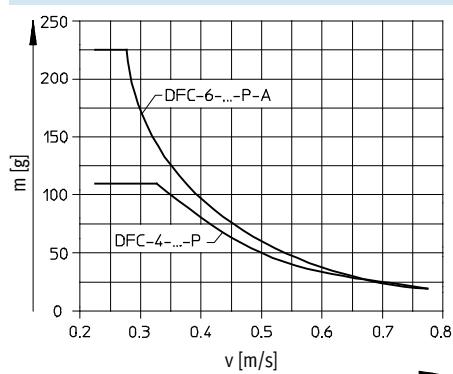

Weights [g]				
Piston Ø	4	6	10	
Product weight	at 5 mm stroke	10	28	91
	at 10 mm stroke	12	34	100
	at 15 mm stroke	15	39	108
	at 20 mm stroke	18	44	117
	at 25 mm stroke	–	49	125
	at 30 mm stroke	–	55	134
Moving load at 0 mm stroke	3.2	8.8	27.2	
Additional load per 10 mm stroke	1.3	2.8	7.2	

### Materials

Sectional view

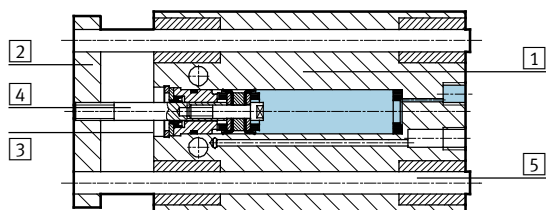

Mini guided cylinder		
1	Housing	Wrought aluminium alloy
2	Yoke plate	Wrought aluminium alloy
3	Cover	Wrought aluminium alloy
4	Piston rod	High-alloy stainless steel
5	Guide rods	High-alloy steel
–	Seals	Polyurethane, nitrile rubber

# Mini guided cylinders DFC

Technical data

## Maximum effective load F [N]

Plain-bearing guide GF and recirculating ball bearing guide KF

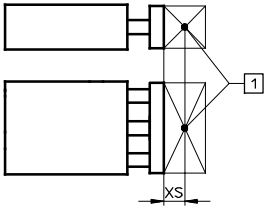

1 Centre of gravity of effective load

Piston Ø [mm]	XS [mm]	Stroke [mm]						
		5	10	15	20	25	30	
4	GF	5	1.7	1.7	1.7	1.7	-	-
	KF		-	-	-	-	-	-
6	GF	10	4.8	4.8	4.8	4.8	4.8	4.8
	KF		4.6	4.6	4.6	4.6	4.6	4.6
10	GF	15	12.2	12.2	12.2	12.2	12.2	12.2
	KF		9.8	9.8	9.8	9.8	9.8	9.8

## Permissible torque load M [Nm]

Plain-bearing guide GF and recirculating ball bearing guide KF

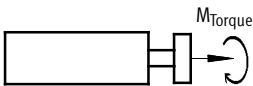

Piston Ø [mm]	Stroke [mm]	5	10	15	20	25	30
		4	GF	0.02	0.02	0.02	0.02
	KF	-	-	-	-	-	-
6	GF	0.1	0.1	0.1	0.1	0.1	0.1
	KF	0.1	0.1	0.1	0.1	0.1	0.1
10	GF	0.4	0.4	0.4	0.4	0.4	0.4
	KF	0.3	0.3	0.3	0.3	0.3	0.3

## Torsional backlash p

Plain-bearing guide GF and recirculating ball bearing guide KF

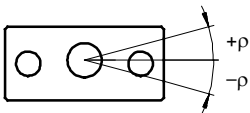

Piston Ø		4	6	10
<b>In retracted state</b>				
Torsional backlash [°]	GF	0.07	0.05	0.04
	KF	0.07	0.05	0.03
<b>In advanced state with maximum stroke</b>				
Torsional backlash [°]	GF	0.11	0.07	0.06
	KF	0.12	0.08	0.05

# Mini guided cylinders DFC

Technical data

## Deflection of piston rod

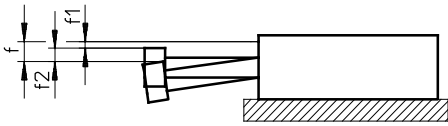

$$f = f_1 + f_2$$

f = Total deflection of piston rod

f1 = Deflection due to bearing backlash = max. 0.02 mm

f2 = Deflection due to lateral force

## Deflection f2 due to lateral force F as a function of the stroke

Piston Ø 4 mm

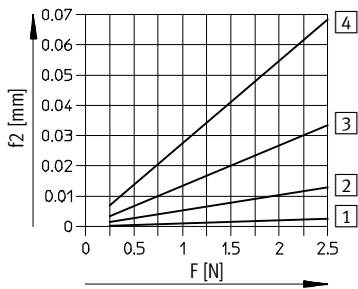

Piston Ø 6 mm

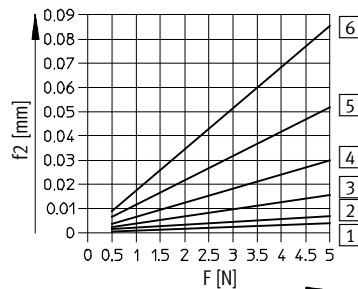

Piston Ø 10 mm

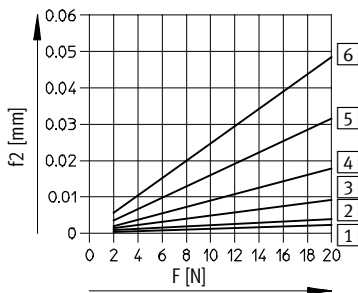

- 1 5 mm stroke
- 2 10 mm stroke
- 3 15 mm stroke
- 4 20 mm stroke
- 5 25 mm stroke
- 6 30 mm stroke

Mini guided cylinders DFC

Technical data

Dimensions

Download CAD data → [www.festo.com](http://www.festo.com)

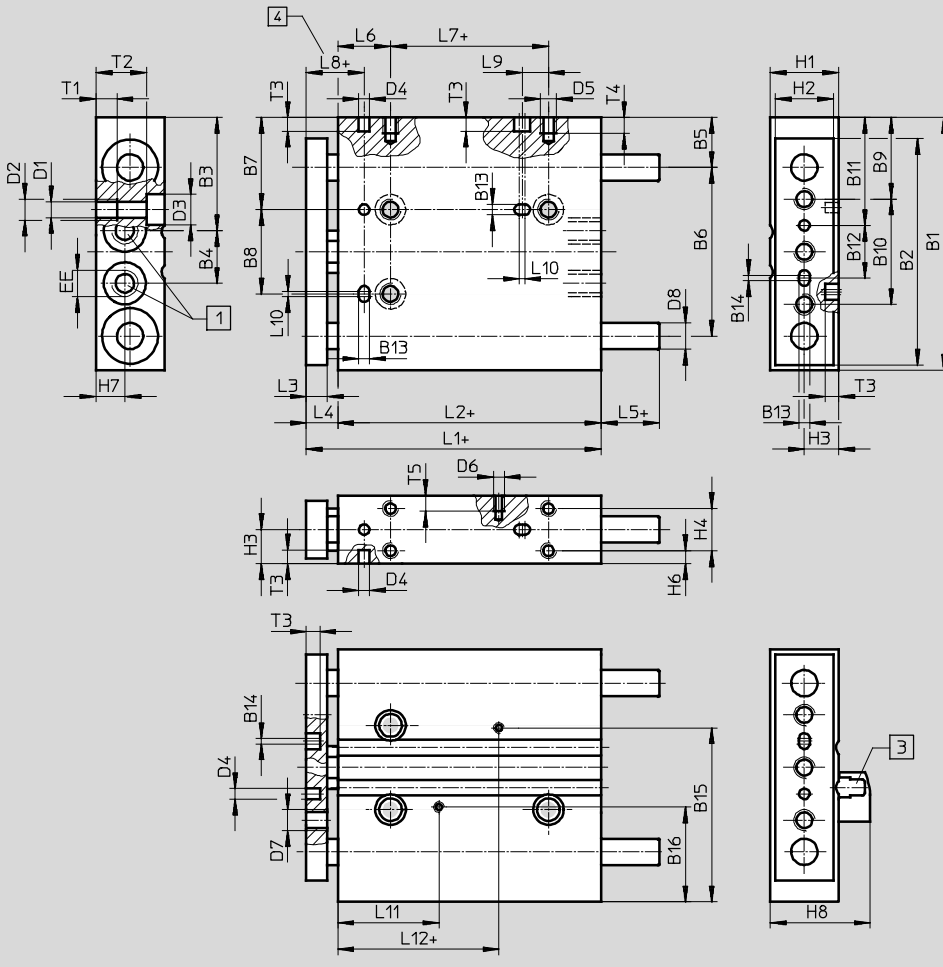

- 1 Supply port
- 3 Sensor bracket  
(included in the scope of delivery of the mini slide unit)
- 4 Dimension L8 set when extended

+ = plus stroke length

Piston Ø 4 mm

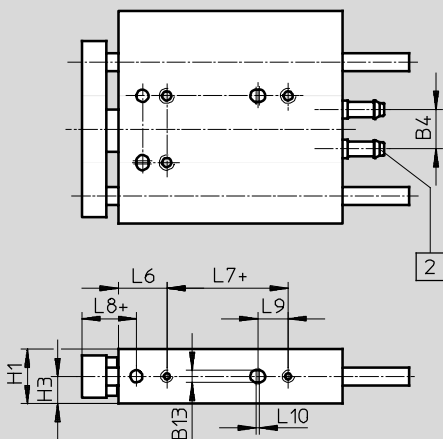

- 2 Barbed fitting PK-3 for 3 mm plastic tubing

+ = plus stroke length



**Mini guided cylinders DFC**

Technical data

∅ [mm]	B1	B2	B3	B4	B5	B6	B7	B8	B9	B10	B11	B12	B13 H8	B14	B15	B16	D1 ∅
4	24	20	9.8	7.4	6	15	9.5	8	8.5	10	11	5	2	-	-	-	2.1
6	35	29	17	6.5	8.5	22	14	11	12	15	15.75	8	2	1	26.2	12.8	2
10	48	43	21.5	10	9.5	32	17.5	16	15.5	20	20.5	10	2	1	33	18	3.2

∅ [mm]	D2	D3 ∅	D4 ∅ H8	D5	D6 ∅	D7	D8 ∅	EE	H1	H2	H3	H4	H6	H7	H8	L1	L2
4	-	-	2	M2	-	M2	2	-	5.5	4.5	2.75	-	2.75	2.75	-	24	18
6	M2.5	4	2	M2.5	M2	M2.5	3	M3	9	7	4.5	-	4.5	3.5	15	34	27
10	M4	5.8	2	M3	M2	M4	5	M5	13	11	6.5	8	2.5	5.5	19	48	40

∅ [mm]	L3	L4 +0.3 -0.9	L5	L6	L7	L8 +0.2	L9	L10	L11	L12	T1	T2	T3	T4	T5
4	4	6	1	8	3	11	3.5	0.5	-	-	-	5.5	2	4	-
6	5	7	1	8	10	10	5	0.5	16	19.35	3	6.1	2.6	5	2.5
10	6	8	1	10	20	13	5	1	22.2	25.6	4	9.6	2.6	3	3

<b>Ordering data</b>																	
Piston ∅ [mm]	Stroke [mm]	Plain-bearing guide GF						Recirculating ball bearing guide KF									
		Part No.		Type				Part No.		Type							
4	5	189 479	DFC-4-5-P-GF				-										
	10	189 452	DFC-4-10-P-GF														
	15	189 453	DFC-4-15-P-GF														
	20	189 454	DFC-4-20-P-GF														
6	5	189 455	DFC-6-5-P-A-GF <sup>1)</sup>				189 461	DFC-6-5-P-A-KF <sup>1)</sup>									
	10	189 456	DFC-6-10-P-A-GF <sup>1)</sup>				189 462	DFC-6-10-P-A-KF <sup>1)</sup>									
	15	189 457	DFC-6-15-P-A-GF <sup>1)</sup>				189 463	DFC-6-15-P-A-KF <sup>1)</sup>									
	20	189 458	DFC-6-20-P-A-GF <sup>1)</sup>				189 464	DFC-6-20-P-A-KF <sup>1)</sup>									
	25	189 459	DFC-6-25-P-A-GF <sup>1)</sup>				189 465	DFC-6-25-P-A-KF <sup>1)</sup>									
	30	189 460	DFC-6-30-P-A-GF <sup>1)</sup>				189 466	DFC-6-30-P-A-KF <sup>1)</sup>									
10	5	189 467	DFC-10-5-P-A-GF <sup>1)</sup>				189 473	DFC-10-5-P-A-KF <sup>1)</sup>									
	10	189 468	DFC-10-10-P-A-GF <sup>1)</sup>				189 474	DFC-10-10-P-A-KF <sup>1)</sup>									
	15	189 469	DFC-10-15-P-A-GF <sup>1)</sup>				189 475	DFC-10-15-P-A-KF <sup>1)</sup>									
	20	189 470	DFC-10-20-P-A-GF <sup>1)</sup>				189 476	DFC-10-20-P-A-KF <sup>1)</sup>									
	25	189 471	DFC-10-25-P-A-GF <sup>1)</sup>				189 477	DFC-10-25-P-A-KF <sup>1)</sup>									
	30	189 472	DFC-10-30-P-A-GF <sup>1)</sup>				189 478	DFC-10-30-P-A-KF <sup>1)</sup>									



1) Mounting kits for proximity sensors included in scope of delivery.

## Mini guided cylinders DFC

Accessories

Ordering data – Proximity sensors for C-slot, magneto-resistive						Technical data → Internet: smt	
	Type of mounting	Switch output	Electrical connection, connection direction	Cable length [m]	Part No.	Type	
N/O contact							
	Insertable in the slot from above	PNP	Plug M8x1, 3-pin, in-line	0.3	551 375	SMT-10M-PS-24V-E-0,3-L-M8D	
			Cable, 3-wire, in-line	2.5	551 373	SMT-10M-PS-24V-E-2,5-L-OE	

Ordering data – Proximity sensors for C-slot, magnetic reed						Technical data → Internet: sme	
	Type of mounting	Switch output	Electrical connection, connection direction	Cable length [m]	Part No.	Type	
N/O contact							
	Insertable in the slot lengthwise	Contacting	Plug M8x1, 3-pin, in-line	0.3	173 212	SME-10-SL-LED-24	
			Cable, 3-wire, in-line	2.5	173 210	SME-10-KL-LED-24	

Ordering data – Connecting cables					Technical data → Internet: nebu	
	Electrical connection, left	Electrical connection, right	Cable length [m]	Part No.	Type	
	Straight socket, M8x1, 3-pin	Cable, open end, 3-wire	2.5	541 333	NEBU-M8G3-K-2.5-LE3	
			5	541 334	NEBU-M8G3-K-5-LE3	
	Angled socket, M8x1, 3-pin	Cable, open end, 3-wire	2.5	541 338	NEBU-M8W3-K-2.5-LE3	
			5	541 341	NEBU-M8W3-K-5-LE3	

Ordering data – One-way flow control valves				Technical data → Internet: grlz	
	Connection		Material	Part No.	Type
	Thread	For tubing OD			
	M5	3	Metal design	193 153	GR LZ-M5-QS-3-D
		4		193 154	GR LZ-M5-QS-4-D
		6		193 155	GR LZ-M5-QS-6-D