

Solenoid/pneumatic valves, Tiger 2000

FESTO



Solenoid/pneumatic valves, Tiger 2000

Key features

FESTO

General information

- A complete and comprehensive range with 5/2-way and 5/3-way valves
- Poppet valve for monostable functions or piston spool for more complex versions with air spring and 5/3-way valves
- With flow-optimised internal functions for higher flow rates with the same width
- Pneumatic connections G1/8, G1/4, G3/8
- Diverse and flexible, side and front mounting
- Pneumatic or electrical actuation
- Versatile connection technology with F or V solenoid coil with low power consumption, even for mounting on valve terminals
- Functional and timeless design, enclosed front housing

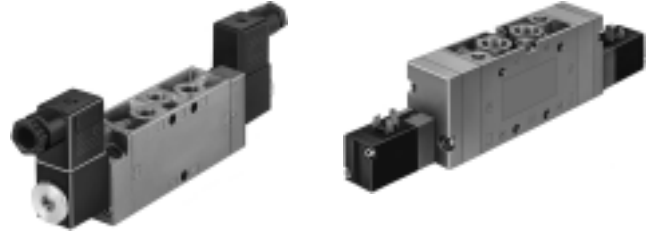

Solenoid coils

F solenoid coils

Voltage:

- 12 to 230 V DC
- 12 to 240 V AC (50 to 60 Hz)

Power consumption:

- 4.1 to 5.5 W DC
- 3.85 to 9 VA AC

- For all MFH valves
- Selected types in accordance with ATEX directive for potentially explosive atmospheres
- ➔ www.festo.com/en/ex

- Solenoid coil can be easily exchanged later
- Solenoid coil not included in scope of delivery

V solenoid coils

Voltage:

- 24 V DC

Power consumption:

- 2.5 W

- For all MVH valves
- Low heating

- Solenoid coil included in scope of delivery

Manifold assembly

With PAL manifold rail



With PRS manifold block



The Tiger 2000 valves (without an ATEX category) can be mounted on PAL manifold rails with a common supply port or on PRS manifold blocks with a common supply port and exhaust. The manifold rail and manifold block have 2 to 10 valve positions.

Note

Valves for explosive atmospheres (ATEX category) are not suitable for mounting on PAL manifold rails or PRS manifold blocks.

Solenoid/pneumatic valves, Tiger 2000

Key features

FESTO

Valve terminals



Completely assembled valve terminal type 02, ready to be connected, available with Tiger 2000 valves (V solenoid coil).

Choice of connections:

- Main multipin plug
- Fieldbus connection for all common fieldbus protocols
- Autonomous with integrated control (PLC)
- For G1/8 and G1/4

Manual override for valves with V solenoid coil

Non-detenting (standard)

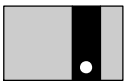

Press on the aluminium plate

Conversion to detenting actuation

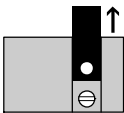

1 Remove the aluminium plate

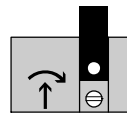

2 Using a screwdriver, simultaneously push and turn the exposed manual override

Blocking the manual override

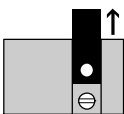

1 Remove the aluminium plate

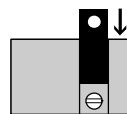

2 Turn the aluminium plate by 180° and reinsert it



3 The manual override is now blocked

Pilot exhaust air for valves with V solenoid coil

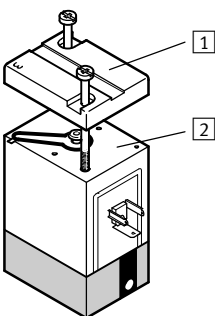

- 1 The coil end cap must not be turned when removing the seal
- 2 Seal inserted

Free pilot exhaust air
Unducted once the seal in the coil end cap is removed, with code 3 on the end cap always corresponding to ports 84 and/or 82 of the valve.

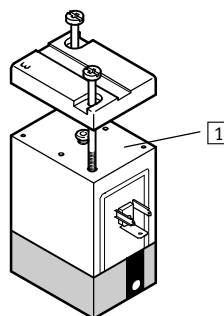

- 1 Seal removed

Solenoid valves, Tiger 2000

Product range overview

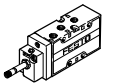
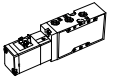
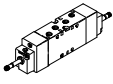
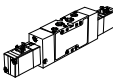

Function	Version	Type	Pneumatic connection	Operating voltage		Pilot air supply		Type of reset		→ Page/ Internet
				[V DC]	[V AC]	Internal	External	Pneumatic spring	Mechanical spring	
5/2-way valves	Solenoid valve									
		MFH	G1/8	12, 24, 42,	12, 24, 42,	■	■	■	■	11
			G1/4	48	48, 110,	■	■	■	■	
			G3/8		230, 240	■	■	■	■	
		MVH	G1/8	24	–	■	■	■	■	32
			G1/4			■	■	■	■	
			G3/8			■	■	■	■	
	Double solenoid valve									
		JMFH	G1/8	12, 24, 42,	12, 24, 42,	■	■	–	–	19
			G1/4	48	48, 110,	■	■	–	–	
G3/8				230, 240	■	■	–	–		
	JMVH	G1/8	24	–	■	■	–	–	39	
		G1/4			■	■	–	–		
		G3/8			■	■	–	–		

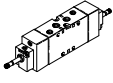
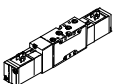
Function	Version	Type	Pneumatic connection	Operating voltage		Pilot air supply		Normal position			→ Page/ Internet
				[V DC]	[V AC]	Internal	External	Closed	Exhausted	Pressurised	
5/3-way valves	Solenoid valve										
		MFH-5/3	G1/8	12, 24,	12, 24,	■	■	■	■	■	24
			G1/4	42, 48	42, 48,	■	■	■	■	■	
			G3/8		110, 230, 240	■	■	■	■	■	
		MVH-5/3	G1/8	24	–	■	■	■	■	■	45
			G1/4			■	■	■	■	■	
G3/8					■	■	■	■	■		

Pneumatic valves, Tiger 2000

Product range overview

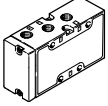
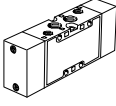
Function	Version	Type	Pneumatic connection	Type of reset		→ Page/Internet
				Pneumatic spring	Mechanical spring	
5/2-way valves	Pneumatic valve					
		VL	G1/8	-	■	57
			G1/4	-	■	
			G3/8	-	■	
	Pneumatic bistable valve					
		J	G1/8	-	-	58
G1/4			-	-		
G3/8			-	-		

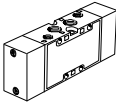
Function	Version	Type	Pneumatic connection	Normal position			→ Page/Internet
				Closed	Exhausted	Pressurised	
5/3-way valves	Pneumatic valve						
		VL	G1/8	■	■	■	62
			G1/4	■	■	■	
			G3/8	■	■	■	

Solenoid valves, Tiger 2000

Peripherals overview

Mounting on manifold block

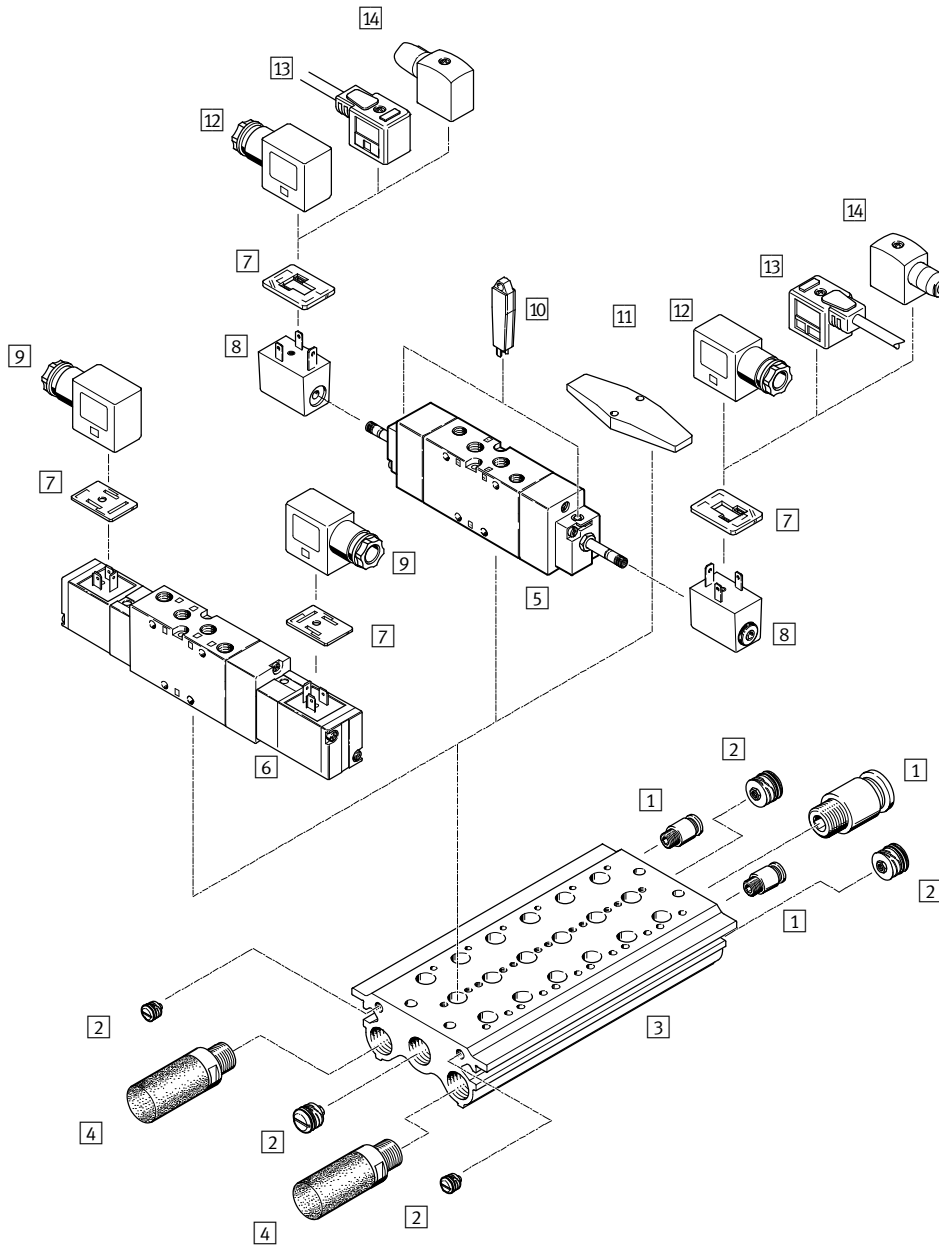

Variants

MFH-5...-B

MVH-5...-B

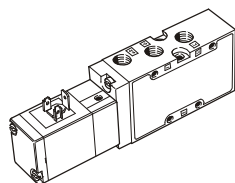
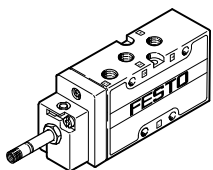

Solenoid valves, Tiger 2000

Peripherals overview

Accessories		
	Brief description	→ Page/Internet
1	Push-in fitting QS	qs
2	Blanking plug PRSV	70
3	Manifold block PRS	68
4	Silencer	For mounting in exhaust ports qs
5	Solenoid valve MFH	Basic valve for F solenoid coil 4
6	Solenoid valve MVH	With V solenoid coil 4
7	Illuminating seal M...-LD	For indicating the switching status 73
8	F solenoid coil MSFG, MSFW	F solenoid coil for basic valves MFH, JMFH 71
9	Plug socket MSSD-V	For solenoid valves MVH, JMVH 73
10	Manual override AHB	By inserting and turning the manual override AHB (by 90°), the valve can be engaged 71
11	Cover plate PRSB	For covering vacant positions 70
12	Plug socket MSSD-F	For solenoid valves MFH, JMFH 72
13	Connecting cable KMF	For solenoid valves MFH, JMFH 72
14	Plug socket MSSD-F-S	For solenoid valves MFH, JMFH 72

Solenoid valves, Tiger 2000

Peripherals overview

Accessories		
	Brief description	→ Page/Internet
1	Push-in fitting QS	qs
2	Blanking plug PRSV	70
3	Manifold rail PAL	66
4	Silencer	For mounting in exhaust ports u
5	Solenoid valve MFH	Basic valve for F solenoid coil 4
6	Solenoid valve MVH	With V solenoid coil 4
7	Illuminating seal M...-LD	For indicating the switching status 73
8	F solenoid coil MSFG, MSFW	F solenoid coil for basic valves MFH, JMFH 71
9	Plug socket MSSD-V	For solenoid valves MVH, JMVH 73
10	Manual override AHB	By inserting and turning the manual override AHB (by 90°), the valve can be engaged 71
11	Cover plate PALB	For covering vacant positions 70
12	Plug socket MSSD-F	For solenoid valves MFH, JMFH 72
13	Connecting cable KMF	For solenoid valves MFH, JMFH 72
14	Plug socket MSSD-F-S	For solenoid valves MFH, JMFH 72

Solenoid valves, Tiger 2000

Type codes

FESTO

MFH – 5/3 G – 1/8 – – – B – EX – VI – X

Type	
MFH	Single solenoid, for F solenoid coil
MVH	Single solenoid, with V solenoid coil
JMFH	Double solenoid, for F solenoid coil
JMVH	Double solenoid, with V solenoid coil

Valve function	
5	5/2-way valve
5/3	5/3-way valve

Normal position	
G	Closed
E	Exhausted
B	Pressurised

Pneumatic connection	
1/8	G1/8
1/4	G1/4
3/8	G3/8

Type of reset	
–	Mechanical spring
L	Pneumatic spring

Pilot air supply	
–	Internal
S	External

Generation	
B	B series

CE marking	
–	None
EX	ATEX category → technical data

Additional usage	
VI	Valve terminal

Additional usage	
X	Via accessories

Solenoid valves MFH-B, Tiger 2000

FESTO

Technical data – 5/2-way valves

-  Flow rate
750 ... 2000 l/min

-  Voltage
12, 24, 42, 48 V DC
24, 42, 48, 110, 230,
240 V AC
Wearing parts kits
→ 16



General technical data							
Pneumatic connection	G1/8		G1/4		G3/8		
Reset method	Mechanical	Pneumatic	Mechanical	Pneumatic	Mechanical	Pneumatic	
Valve function	5/2-way, single solenoid						
Design	Poppet seat	Piston spool	Poppet seat	Piston spool			
Lap	Underlap	Overlap	Underlap	Overlap			
Sealing principle	Soft						
Actuation type	Electrical						
Control type	Pilot-actuated						
Pilot air supply	Internal or external						
Flow direction	Reversible or not reversible (see switching symbol)						
Exhaust air function	With flow control						
Manual override	Non-detenting						
Type of mounting	With through-hole						
Mounting position	Any						
Electrical connection	Via F solenoid coil, to be ordered separately						
b value	0.34	–	0.29	0.38	–	–	
c value	[l/s bar]	3	–	5.5	6.35	–	–
Nominal width	[mm]	5	8	7	10	12	12
Standard nominal flow rate	[l/min.]	750	1000	1300	1600	2000	2000
Grid dimension	[mm]	27		33		41	
Valve width	[mm]	26		32		40	
Product weight	[g]	220, 250 ¹⁾	280, 300 ¹⁾	300, 360 ¹⁾	380	630	630

1) ATEX valve

Safety data		
Max. switching frequency	[Hz]	3
Max. positive test pulse with 0 signal	[µs]	2200
Max. negative test pulse with 1 signal	[µs]	3700

ATEX	
Type	MFH- ... -EX, JMFH- ... -EX
ATEX category gas	II 2G
Type of (ignition) protection for gas	Ex h IIC T4 Gb
ATEX category for dust	II 2D
Type of (ignition) protection for dust	Ex h IIIC T1 30°C Db
Explosion-proof ambient temperature	[°C] –5 ≤ Ta ≤ +40
CE marking (see declaration of conformity)	To EU Explosion Protection Directive (ATEX)
Degree of protection	IP65 (in assembled state)

Solenoid valves MFH-B, Tiger 2000



Technical data – 5/2-way valves

Operating and environmental conditions								
Pneumatic connection			G1/8		G1/4		G3/8	
Reset method			Mechanical	Pneumatic	Mechanical	Pneumatic	Mechanical	Pneumatic
Operating medium			Compressed air to ISO 8573-1:2010 [7:4:4]					
Pilot medium (with external pilot air supply)			Compressed air to ISO 8573-1:2010 [7:4:4]					
Note on operating/pilot medium			Operation with lubricated medium possible (in which case lubricated operation will always be required)					
Operating pressure	Internal pilot air supply	[bar]	2 ... 10	3 ... 10	2 ... 10	3 ... 10	2.5 ... 10	2 ... 10
	External pilot air supply	[bar]	-0.9 ... +10, 0 ... 10 ¹⁾	-0.9 ... +10	-0.9 ... +10, 0 ... 10 ¹⁾	-0.9 ... +10	-0.9 ... +10	-0.9 ... +10
Pilot pressure		[bar]	2 ... 10	3 ... 10	2 ... 10	3 ... 10	2.5 ... 10	2 ... 10
Storage temperature		[°C]	-40 ... +60					
Ambient temperature		[°C]	-5 ... +40					
Temperature of medium		[°C]	-10 ... +60					
		[°C]	-5 ... +40 (MFH- ... -EX)					
Corrosion resistance class CRC ²⁾			1					

1) For non-reversible valves

2) Corrosion resistance class CRC 1 to Festo standard FN 940070

Low corrosion stress. For dry indoor applications or transport and storage protection. Also applies to parts behind covers, in the non-visible interior area, and parts which are covered in the application (e.g. drive trunnions).

Electrical data			
F solenoid coil			
Electrical connection of the solenoid coil			Plug vanes for plug sockets MSSD-F, KMF
Operating voltage	DC voltage	[V DC]	12, 24, 42, 48
	AC voltage	[V AC]	24, 42, 48, 110, 230, 240 (50 ... 60 Hz)
Coil characteristics	DC voltage	[W]	4.5
	AC voltage	[VA]	Pull: 7.5 Hold: 6
Degree of protection to EN 60529			IP65 (in combination with plug socket)

Valve switching times [ms]							
Pneumatic connection		G1/8		G1/4		G3/8	
Reset method		Mechanical	Pneumatic	Mechanical	Pneumatic	Mechanical	Pneumatic
On		10	27	12	23	20	25, 27 ¹⁾
Off		30	22	36	42	56	50, 65 ¹⁾

1) For reversible valves

Solenoid valves MFH-B, Tiger 2000

Technical data – 5/2-way valves

Minimum pilot pressure p_{12} , p_{14} as a function of operating pressure p_1 (external pilot air supply)

MFH-5-1/8-S-B

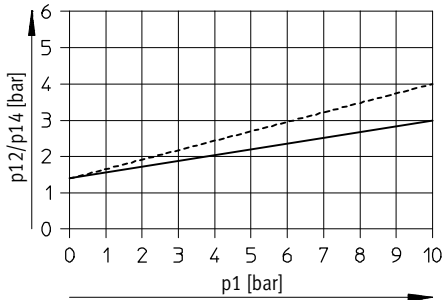

----- Exhausting, throttled
 ———— Exhausting, unthrottled

MFH-5-1/4-S-B

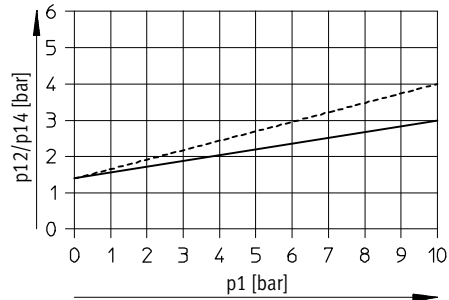

----- Exhausting, throttled
 ———— Exhausting, unthrottled

MFH-5-3/8-S-B

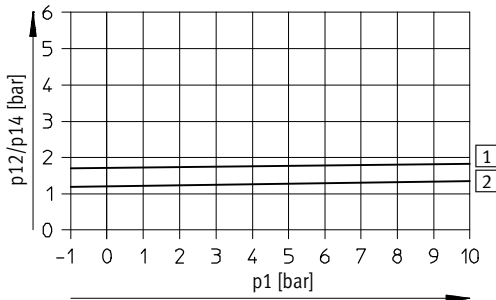

1 On
 2 Off

Materials

Sectional view

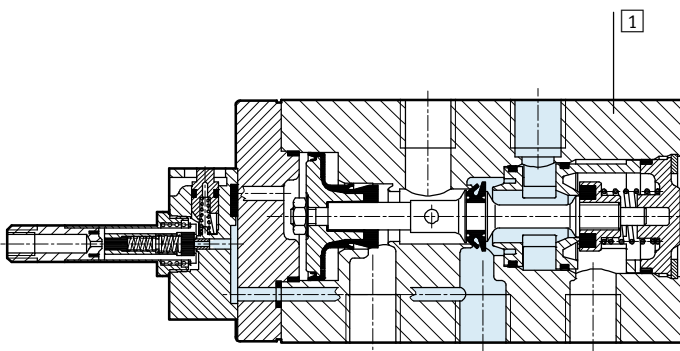

1	Housing	Die-cast aluminium
-	Seals	NBR, TPE-U(PU)
-	Note on materials	RoHS compliant

Solenoid valves MFH-B, Tiger 2000

Technical data – 5/2-way valves



Dimensions – Pneumatic connection G1/8, G1/4

Download CAD data → www.festo.com

Basic valve

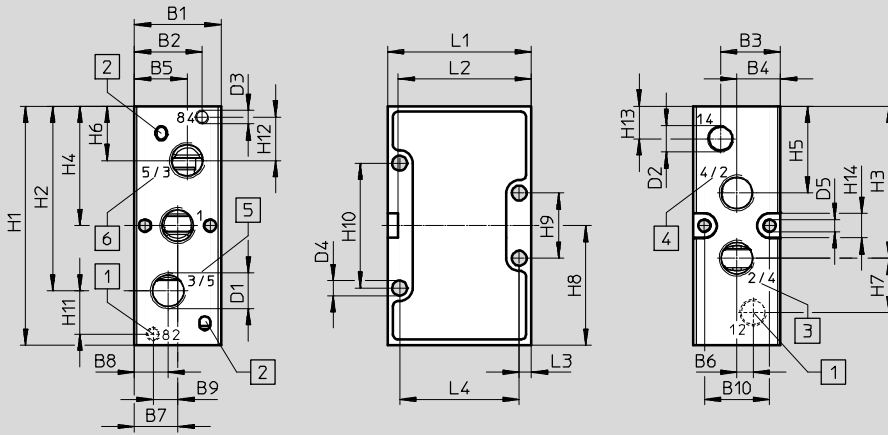

- 1 Connection 12 and 82 are not available with MFH-5-...-B and MFH-5-...-S-B
- 2 Protection against rotation
- 3 2 in case of disc seat valve
4 in case of piston valve
- 4 4 in case of disc seat valve
2 in case of piston valve
- 5 3 in case of disc seat valve
5 in case of piston valve
- 6 5 in case of disc seat valve
3 in case of piston valve

Pneumatic connection	B1	B2	B3	B4	B5	B6	B7	B8	B9	B10	D1	D2	D3	D4	D5	H1	H2
G1/8	26	16.5	18	13	16.5	5	13	9.5	8	19.5	G1/8	G1/8	M5	4.5	4.3	77	59.5
G1/4	32	19.5	22	16	19.5	6	16	12.5	9	24	G1/4			5.5	4.3	88	68

Pneumatic connection	H3	H4	H5	H6	H7	H8	H9	H10	H11	H12	H13	H14	L1	L2	L3	L4
G1/8	49.5	38.5	27.5	17.5	19	38.5 ±0.2	21	41	12	12	8.5	9	47	43	3.5	40
G1/4	56	44	32	20	20	44	22	48	16	16	12		53	49	4.5	44

Installation dimensions with F solenoid coil

Mechanical reset method

Pneumatic reset method

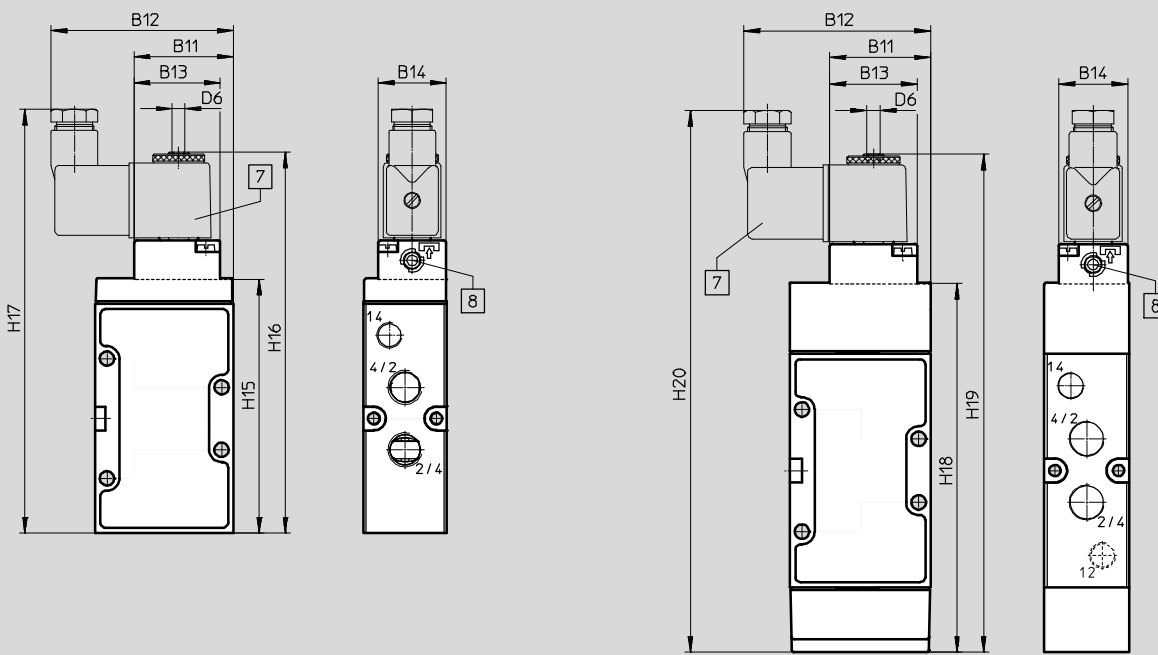

7 Solenoid coil can be rotated by 360°

8 Manual override can be turned by 180°

Type	B11	B12	B13	B14	D6	H18	H19	H20
MFH-5-1/8-	36.8	67	33	26	M5	126.2	175	191.5
MFH-5-1/4-	38	70				139	187.8	204.3

Solenoid valves MFH-B, Tiger 2000

Technical data – 5/2-way valves

Dimensions – Pneumatic connection G3/8

Download CAD data → www.festo.com

Basic valve

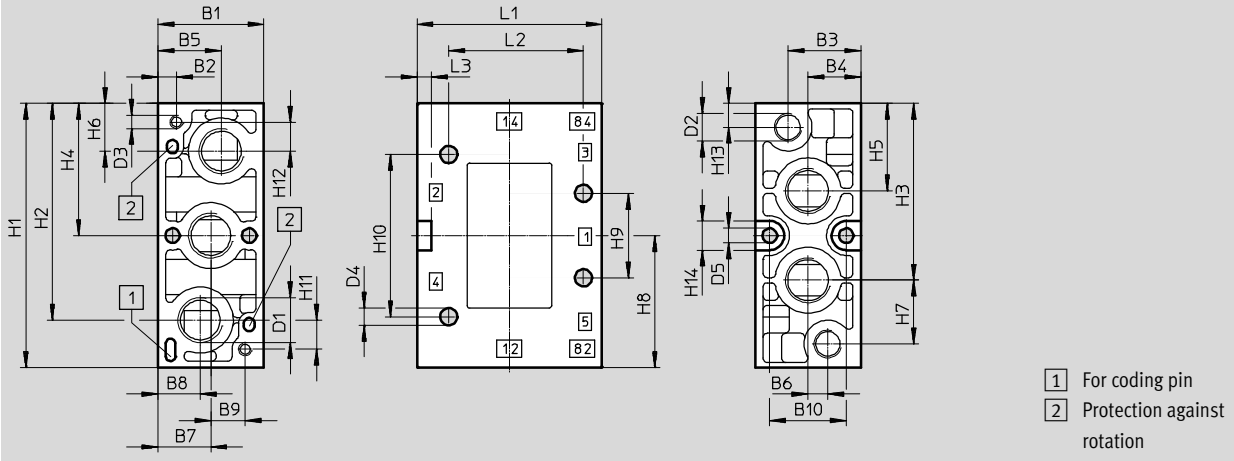

Pneumatic connection	B1 ±0.1	B2	B3	B4	B5	B6	B7	B8	B9	B10	D1 ∅	D2 ∅	D3	D4 ∅	D5
G3/8	40	13	27.5	20	24	7.6	20	16	13	29	G3/8	G1/8	M5	6.5	5.5

Pneumatic connection	H1 ±0.1	H2	H3	H4	H5	H6	H7	H8	H9	H10	H11	H12	H13	H14	L1 ±0.2	L2	L3
G3/8	100	82	66.9	50	33.1	18	24.1	50	32	61.4	11	11	9	11	70	51	5.5

Installation dimensions with F solenoid coil Mechanical or pneumatic reset method

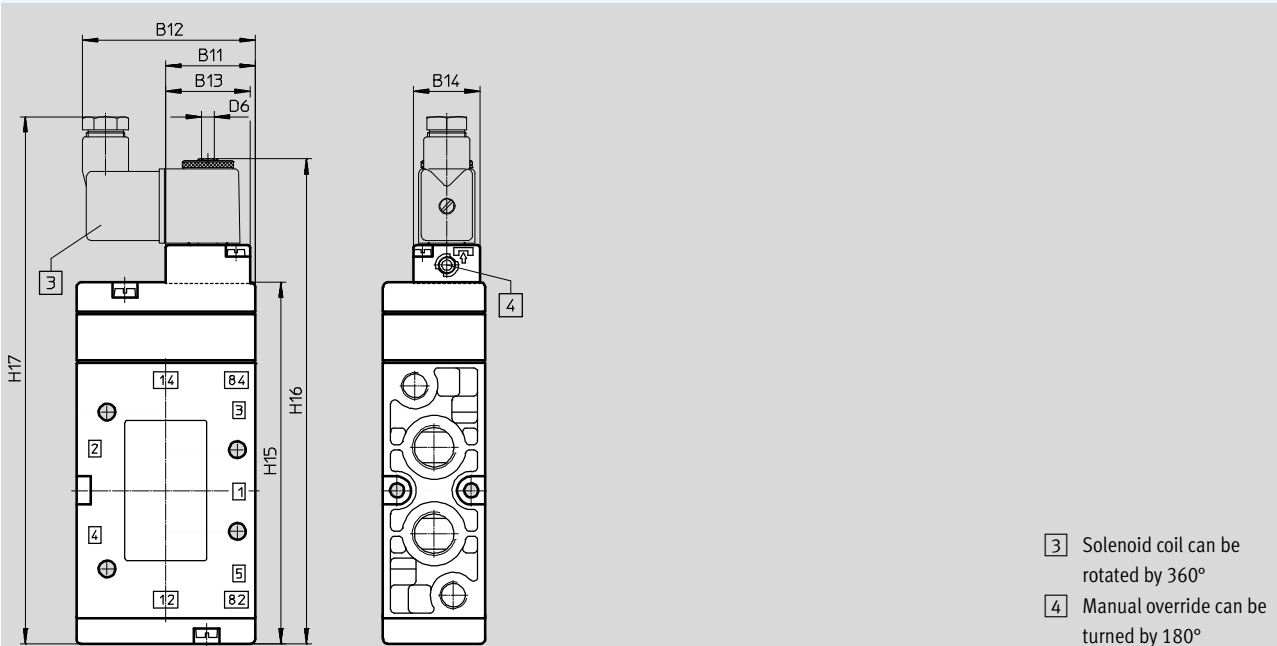

Type	B11	B12	B13	B14	D6	H15	H16	H17
MFH-5-3/8-	35	67.5	33	26	M5	141.5	190	206

Solenoid valves MFH-B, Tiger 2000

Technical data – 5/2-way valves



Ordering data					
Circuit symbol	Description of valve (without F solenoid coil ¹⁾)	Pneumatic connection	ATEX category	Part No.	Type
	Pneumatic reset method Non-reversible flow direction Internal pilot air supply	G1/8	–	30991	MFH-5-1/8-L-B
			ATEX category ➔11	535921	MFH-5-1/8-L-B-EX
		G1/4	–	31010	MFH-5-1/4-L-B
			ATEX category ➔11	535922	MFH-5-1/4-L-B-EX
		G3/8	–	14946	MFH-5-3/8-L-B
			ATEX category ➔11	535923	MFH-5-3/8-L-B-EX
	Pneumatic reset method Reversible flow direction External pilot air supply	G1/8	–	30992	MFH-5-1/8-L-S-B
			ATEX category ➔11	535927	MFH-5-1/8-L-S-B-EX
		G1/4	–	33185	MFH-5-1/4-L-S-B
			ATEX category ➔11	535928	MFH-5-1/4-L-S-B-EX
		G3/8	–	33181	MFH-5-3/8-L-S-B
			ATEX category ➔11	535929	MFH-5-3/8-L-S-B-EX
	Mechanical reset method Non-reversible flow direction Internal pilot air supply	G1/8	–	19758	MFH-5-1/8-B
			ATEX category ➔11	535918	MFH-5-1/8-B-EX
		G1/4	–	15901	MFH-5-1/4-B
			ATEX category ➔11	535919	MFH-5-1/4-B-EX
		G3/8	–	19705	MFH-5-3/8-B
			ATEX category ➔11	535920	MFH-5-3/8-B-EX
	Mechanical reset method Non-reversible flow direction External pilot air supply	G1/8	–	19759	MFH-5-1/8-S-B
			ATEX category ➔11	535924	MFH-5-1/8-S-B-EX
		G1/4	–	15902	MFH-5-1/4-S-B
			ATEX category ➔11	535925	MFH-5-1/4-S-B-EX
		G3/8	–	19706	MFH-5-3/8-S-B
			ATEX category ➔11	535926	MFH-5-3/8-S-B-EX

1) F solenoid coils ➔ 71

Ordering data – Wearing parts kits		
Pneumatic connection	Part No.	Type
G1/8	125710	MFH-5-1/8-B
G1/4	115580	MFH-5-1/4-B
G3/8	115074	MFH-5-3/8-B

Solenoid valves JMFH-B, Tiger 2000

Technical data – 5/2-way valves, double solenoid valves

-  - Flow rate
1000 ... 2000 l/min
-  - Voltage
12, 24, 42, 48 V DC
24, 42, 48, 110, 230,
240 V AC



General technical data			
Pneumatic connection	G1/8	G1/4	G3/8
Valve function	5/2-way, double solenoid		
Design	Piston spool		
Lap	Overlap		
Sealing principle	Soft		
Actuation type	Electrical		
Control type	Pilot-actuated		
Pilot air supply port	Internal or external		
Flow direction	Reversible or not reversible (see switching symbol)		
Exhaust air function	With flow control		
Manual override	Non-detenting		
Type of mounting	With through-hole		
Mounting position	Any		
Electrical connection	Via F solenoid coil, to be ordered separately		
b value	-	0.38	-
c value	[l/s bar]	-	6.35
Nominal width	[mm]	8	10
Standard nominal flow rate	[l/min.]	1000	1600
Grid dimension	[mm]	27	33
Valve width	[mm]	26	32
Product weight	[g]	400, 440 ¹⁾	460

1) ATEX valve

Safety data		
Max. switching frequency	[Hz]	3
Max. positive test pulse with 0 signal	[μs]	2200
Max. negative test pulse with 1 signal	[μs]	3700

Solenoid valves JMFH-B, Tiger 2000

Technical data – 5/2-way valves, double solenoid valves

Operating and environmental conditions				
Pneumatic connection		G1/8	G1/4	G3/8
Operating medium		Compressed air to ISO 8573-1:2010 [7:4:4]		
Pilot medium (with external pilot air supply)		Compressed air to ISO 8573-1:2010 [7:4:4]		
Note on operating/pilot medium		Operation with lubricated medium possible (in which case lubricated operation will always be required)		
Operating pressure	Internal pilot air supply	[bar]	2 ... 10	
	External pilot air supply	[bar]	-0.9 ... +10	
Pilot pressure		[bar]	2 ... 10	
Storage temperature		[°C]	-40 ... +60	
Ambient temperature		[°C]	-5 ... +40	
Temperature of medium		[°C]	-10 ... +60	
		[°C]	-5 ... +40 (JMFH- ... -EX)	
Corrosion resistance class CRC ¹⁾		1		

1) Corrosion resistance class CRC 1 to Festo standard FN 940070

Low corrosion stress. For dry indoor applications or transport and storage protection. Also applies to parts behind covers, in the non-visible interior area, and parts which are covered in the application (e.g. drive trunnions).

Electrical data			
F solenoid coil			
Electrical connection of the solenoid coil		Plug vanes for plug sockets MSSD-F, KMF	
Operating voltage	DC voltage	[V DC]	12, 24, 42, 48
	AC voltage	[V AC]	24, 42, 48, 110, 230, 240 (50 ... 60 Hz)
Coil characteristics	DC voltage	[W]	4.5
	AC voltage	[VA]	Pull: 7.5 Hold: 6
Degree of protection to EN 60529		IP65 (in combination with plug socket)	

Valve switching times [ms]				
Pneumatic connection		G1/8	G1/4	G3/8
Changeover		12	14	12, 14 ¹⁾

1) For reversible valves

Solenoid valves JMFH-B, Tiger 2000

Technical data – 5/2-way valves, double solenoid valves

Minimal pilot pressure p_{12}/p_{14} as a function of operating pressure p_1 (external pilot air supply)

JMFH-5-1/8-S-B

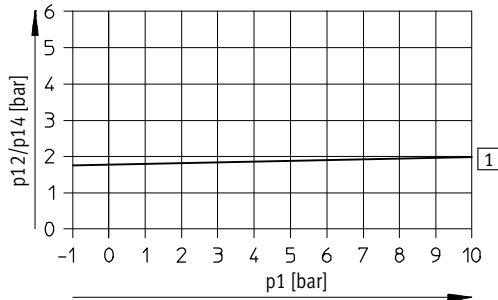

1 On

JMFH-5-1/4-S-B

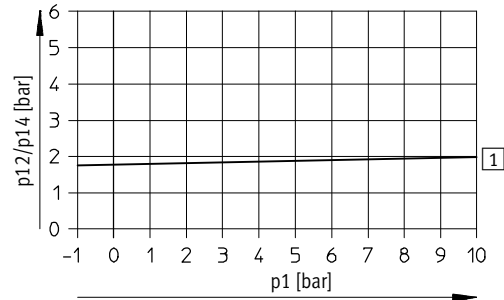

1 On

JMFH-5-3/8-S-B

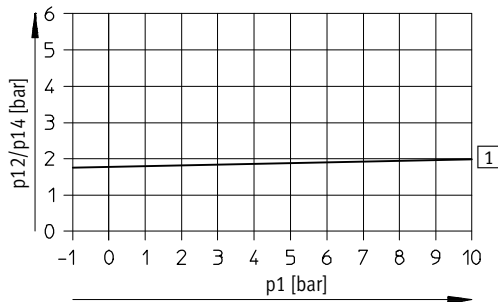

1 On

Materials

Sectional view

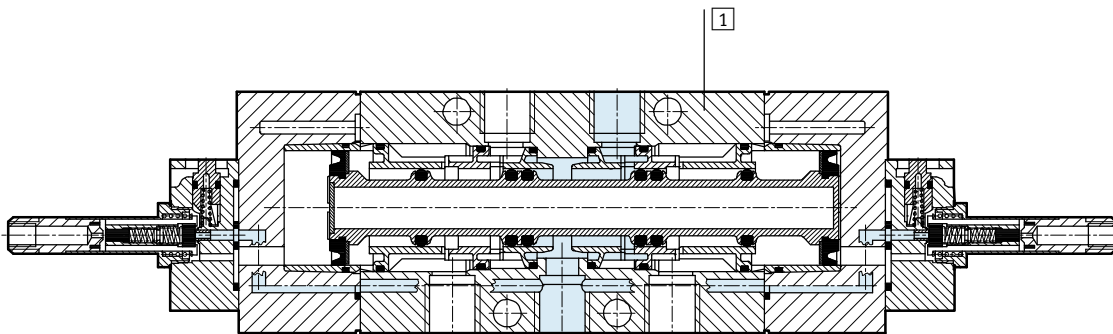

1	Housing	Die-cast aluminium
-	Seals	NBR
	Note on materials	RoHS compliant

Solenoid valves JMFH-B, Tiger 2000

Technical data – 5/2-way valves, double solenoid valves



Dimensions – Pneumatic connection G1/8, G1/4

Download CAD data → www.festo.com

Basic valve

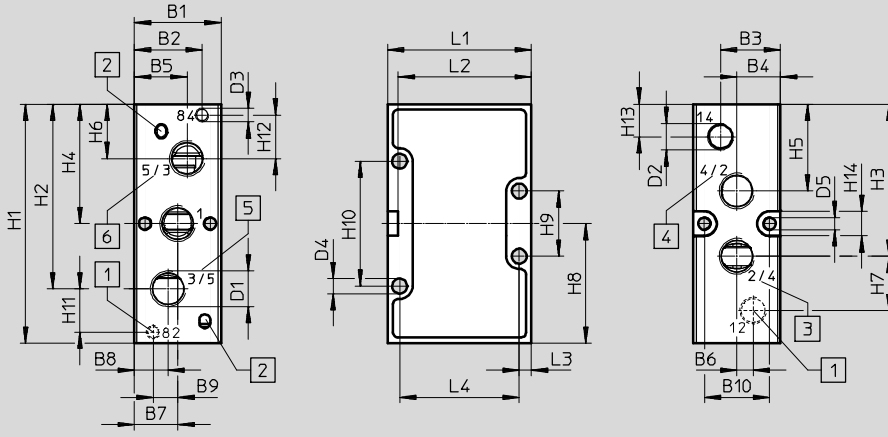

- 1 Connection 12 and 82 are not available with MFH-5-...-B and MFH-5-...-S-B
- 2 Protection against rotation
- 3 2 in case of disc seat valve
4 in case of piston valve
- 4 4 in case of disc seat valve
2 in case of piston valve
- 5 3 in case of disc seat valve
5 in case of piston valve
- 6 5 in case of disc seat valve
3 in case of piston valve

Pneumatic connection	B1	B2	B3	B4	B5	B6	B7	B8	B9	B10	D1	D2	D3	D4	D5	H1	H2
											∅	∅		∅		±0.2	
G1/8	26	16.5	18	13	16.5	5	13	9.5	8	19.5	G1/8	G1/8	M5	4.5	4.3	77	59.5
G1/4	32	19.5	22	16	19.5	6	16	12.5	9	24	G1/4			5.5	4.3	88	68

Pneumatic connection	H3	H4	H5	H6	H7	H8	H9	H10	H11	H12	H13	H14	L1	L2	L3	L4
						±0.2							±0.2			
G1/8	49.5	38.5	27.5	17.5	19	38.5	21	41	12	12	8.5	9	47	43	3.5	40
G1/4	56	44	32	20	20	44	22	48	16	16	12		53	49	4.5	44

Solenoid valves JMFH-B, Tiger 2000

Technical data – 5/2-way valves, double solenoid valves

Dimensions – Pneumatic connection G1/8, G1/4

Download CAD data → www.festo.com

Installation dimensions with F solenoid coil, mechanical or pneumatic reset

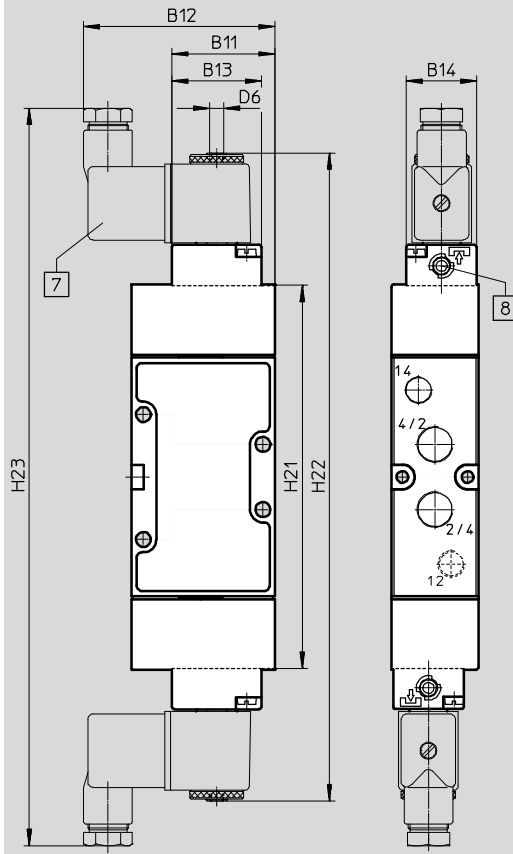

- 7 Solenoid coil can be rotated by 360°
- 8 Manual override can be turned by 180°

Type	B11	B12	B13	B14	D6	H21	H22	H23
JMFH-5-1/8-	36.8	67	33	26	M5	129	226.6	259.6
JMFH-5-1/4-	38	70				141.5	239.1	272.1

Solenoid valves JMFH-B, Tiger 2000

Technical data – 5/2-way valves, double solenoid valves

Dimensions – Pneumatic connection G3/8

Download CAD data → www.festo.com

Basic valve

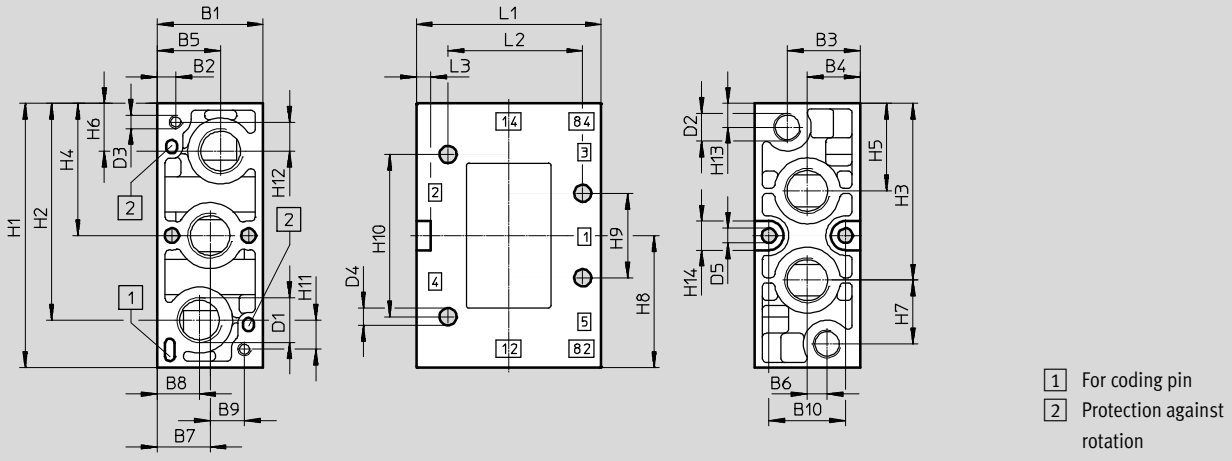

Pneumatic connection	B1 ±0.1	B2	B3	B4	B5	B6	B7	B8	B9	B10	D1 ∅	D2 ∅	D3	D4 ∅	D5
G3/8	40	13	27.5	20	24	7.6	20	16	13	29	G3/8	G1/8	M5	6.5	5.5

Pneumatic connection	H1 ±0.1	H2	H3	H4	H5	H6	H7	H8	H9	H10	H11	H12	H13	H14	L1 ±0.2	L2	L3
G3/8	100	82	66.9	50	33.1	18	24.1	50	32	61.4	11	11	9	11	70	51	5.5

Installation dimensions with F solenoid coil, mechanical or pneumatic reset

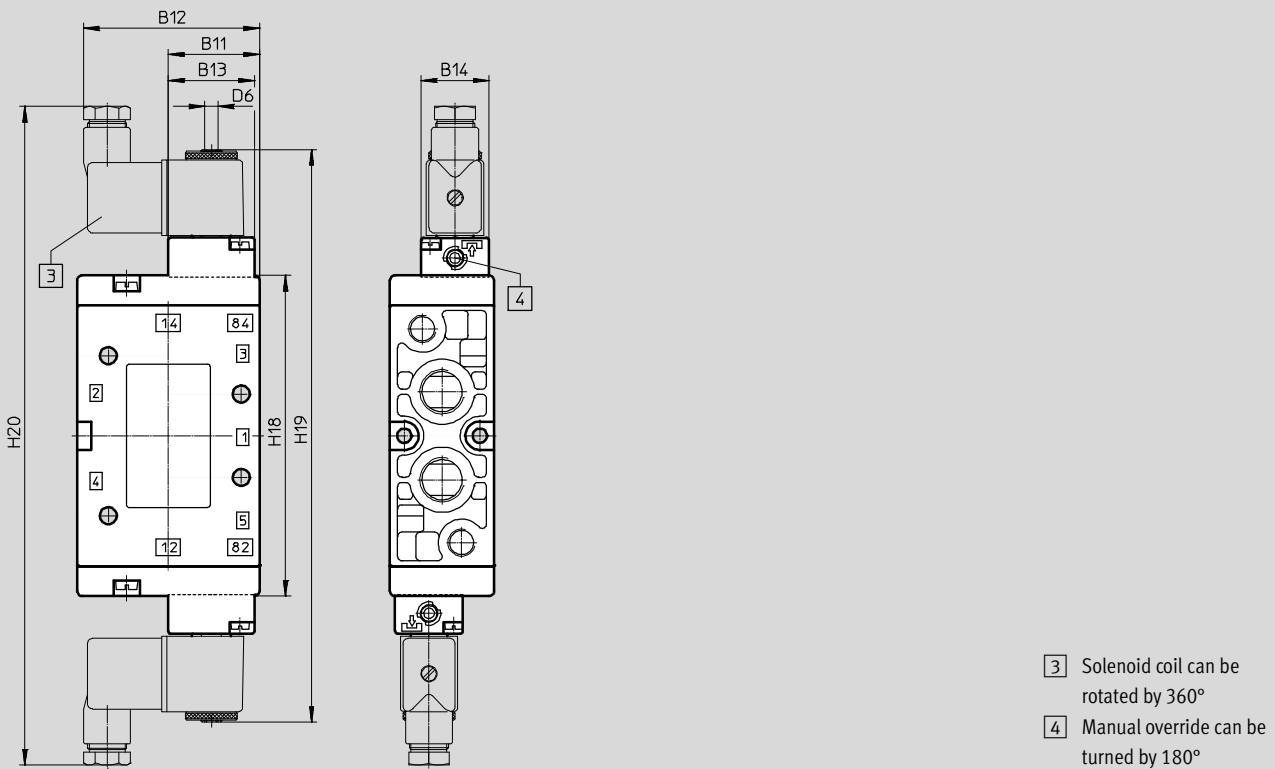

Type	B11	B12	B13	B14	D6	H18	H19	H20
JMFH-5-3/8-	35	67.5	33	26	M5	123	220	253

Solenoid valves JMFH-B, Tiger 2000

Technical data – 5/2-way valves, double solenoid valves



Ordering data					
Circuit symbol	Description of valve (without F solenoid coil ¹⁾)	Pneumatic connection	ATEX category	Part No.	Type
	Non-reversible flow direction Internal pilot air supply	G1/8	–	30486	JMFH-5-1/8-B
			ATEX category →11	535930	JMFH-5-1/8-B-EX
		G1/4	–	19789	JMFH-5-1/4-B
			ATEX category →11	535931	JMFH-5-1/4-B-EX
		G3/8	–	19700	JMFH-5-3/8-B
			ATEX category →11	535932	JMFH-5-3/8-B-EX
	Reversible flow direction External pilot air supply	G1/8	–	30487	JMFH-5-1/8-S-B
			ATEX category →11	535933	JMFH-5-1/8-S-B-EX
		G1/4	–	19790	JMFH-5-1/4-S-B
			ATEX category →11	535934	JMFH-5-1/4-S-B-EX
		G3/8	–	19702	JMFH-5-3/8-S-B
			ATEX category →11	535935	JMFH-5-3/8-S-B-EX

1) F solenoid coils → 71

Solenoid valves MFH-B, Tiger 2000

FESTO

Technical data – 5/3-way valves

-  Flow rate
1000 ... 2600 l/min
-  Voltage
12, 24, 42, 48 V DC
24, 42, 48, 110, 230,
240 V AC



General technical data					
Pneumatic connection		G1/8	G1/4	G3/8	
Valve function		5/3-way, single solenoid			
Design		Piston spool			
Lap		Overlap			
Sealing principle		Soft			
Actuation type		Electrical			
Reset method		Mechanical spring			
Control type		Pilot-actuated			
Pilot air supply		Internal or external			
Flow direction		Reversible or not reversible (see switching symbol)			
Exhaust function		No flow control	With flow control	With flow control	
Manual override		Non-detenting			
Type of mounting		With through-hole			
Mounting position		Any			
Electrical connection		Via F solenoid coil, to be ordered separately			
b value		–	0.38	–	
c value [l/s bar]		–	6.35	–	
Nominal width [mm]		8	10	12	
Nominal flow rate		Closed [l/min.]	1000	1600	2200
		Exhausted [l/min.]			2200
		Pressurised [l/min.]			2600
Grid dimension [mm]		27	33	41	
Valve width [mm]		26	32	40	
Product weight [g]		400, 440 ¹⁾	500	780, 1000 ¹⁾	

1) ATEX valve

Safety data		
Max. switching frequency	[Hz]	3
Max. positive test pulse with 0 signal	[µs]	2200
Max. negative test pulse with 1 signal	[µs]	3700

ATEX	
Type	MFH- ... -EX, JMFH- ... -EX
ATEX category gas	II 2G
Type of (ignition) protection for gas	Ex h IIC T4 Gb
ATEX category for dust	II 2D
Type of (ignition) protection for dust	Ex h IIIC T1 30°C Db
Explosion-proof ambient temperature	[°C] –5 ≤ Ta ≤ +40
CE marking (see declaration of conformity)	To EU Explosion Protection Directive (ATEX)
Degree of protection	IP65 (in assembled state)

Solenoid valves MFH-B, Tiger 2000

Technical data – 5/3-way valves

Operating and environmental conditions					
Pneumatic connection		G1/8	G1/4	G3/8	
Operating medium		Compressed air to ISO 8573-1:2010 [7:4:4]			
Pilot medium (with external pilot air supply)		Compressed air to ISO 8573-1:2010 [7:4:4]			
Note on operating/pilot medium		Operation with lubricated medium possible (in which case lubricated operation will always be required)			
Operating pressure	Internal pilot air supply	[bar]	3 ... 10	3 ... 10	3 ... 10
	External pilot air supply	[bar]	–0.9 ... +10	–0.9 ... +10	–0.9 ... +10
Pilot pressure		[bar]	3 ... 10	3 ... 10	3 ... 10
Storage temperature		[°C]	–40 ... +60		
Ambient temperature		[°C]	–5 ... +40		
Temperature of medium		[°C]	–10 ... +60		
		[°C]	–5 ... +40 (MFH- ... -EX)		
Corrosion resistance class CRC ¹⁾			1		

1) Corrosion resistance class CRC 1 to Festo standard FN 940070

Low corrosion stress. For dry indoor applications or transport and storage protection. Also applies to parts behind covers, in the non-visible interior area, and parts which are covered in the application (e.g. drive trunnions).

Electrical data			
F solenoid coil			
Electrical connection of the solenoid coil		Plug vanes for plug sockets MSSD-F, KMF	
Operating voltage	DC voltage	[V DC]	12, 24, 42, 48
	AC voltage	[V AC]	24, 42, 48, 110, 230, 240 (50 ... 60 Hz)
Coil characteristics	DC voltage	[W]	4.5
	AC voltage	[VA]	Pull: 7.5 Hold: 6
Protection class to EN 60529		IP65 (in combination with plug socket)	

Valve switching times [ms]									
Pneumatic connection	G1/8			G1/4			G3/8		
	On	Off ²⁾	Changeover	On	Off ³⁾	Changeover	On	Off ⁴⁾	Changeover
Closed	20 ¹⁾ , 23	23 ¹⁾ , 30	23	18	30	30	20 ¹⁾ , 24	80, 96 ¹⁾	54 ¹⁾
Exhausted	21	20	24	23	32	37	26	114	83
Pressurised	23	21	16	22	23	35	25	118	78

1) With external pilot air supply and/or ATEX valves

2) After long electrical actuation (> 16 h), the switch-off time of 5/3-way valves can increase to max. 50 ms.

3) After long electrical actuation (> 16 h), the switch-off time of 5/3-way valves can increase to max. 100 ms.

4) After long electrical actuation (> 16 h), the switch-off time of 5/3-way valves can increase to max. 150 ms.

Solenoid valves MFH-B, Tiger 2000

Technical data – 5/3-way valves



Minimal pilot pressure p_{12}/p_{14} as a function of operating pressure p_1 (external pilot air supply)

MFH-5/3...-1/8-S-B

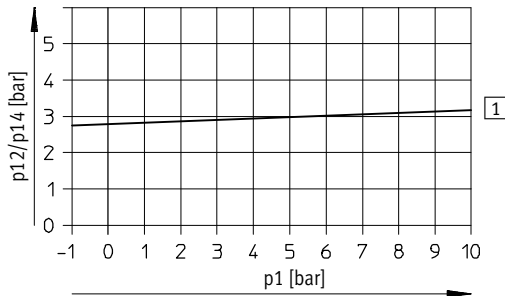

1 On

MFH-5/3...-1/4-S-B

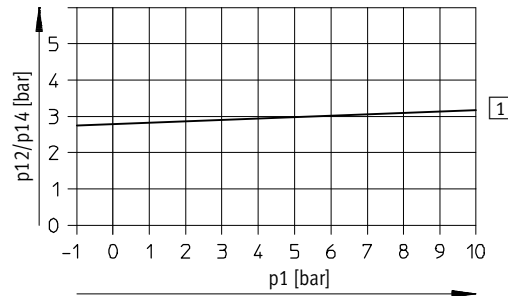

1 On

MFH-5/3...-3/8-S-B

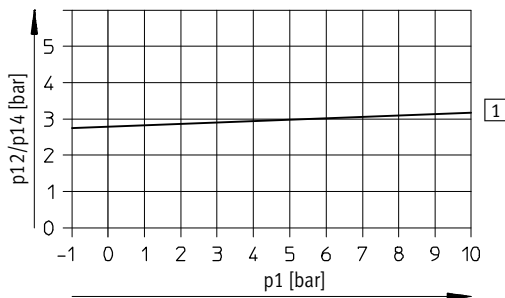

1 On

Materials

Sectional view

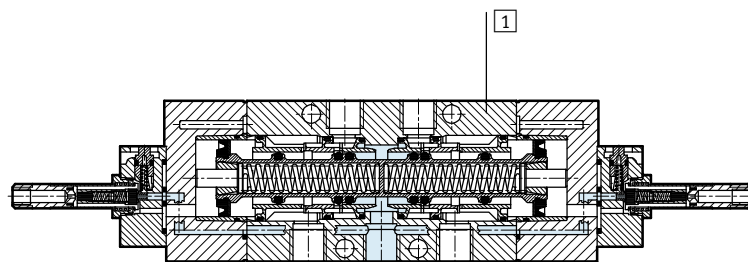

1	Housing	Die-cast aluminium
-	Seals	NBR
-	Note on materials	RoHS compliant

Solenoid valves MFH-B, Tiger 2000

Technical data – 5/3-way valves

Dimensions – Pneumatic connection G1/8, G1/4

Download CAD data → www.festo.com

Basic valve

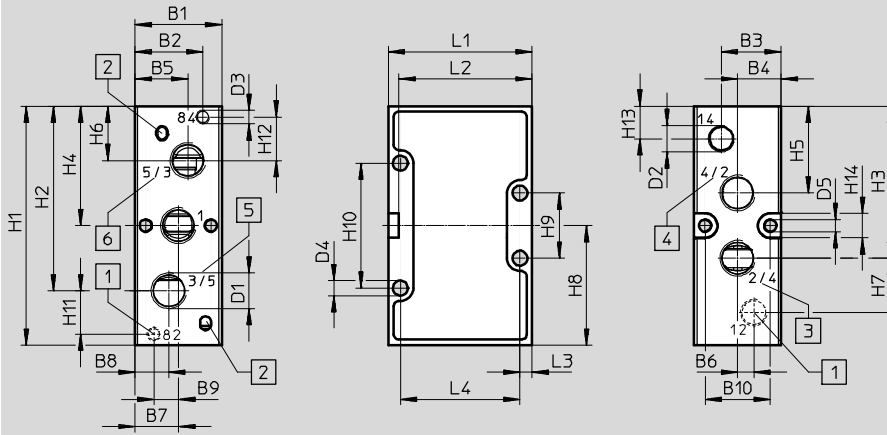

- 1 Connection 12 and 82 are not available with MFH-5-...-B and MFH-5-...-S-B
- 2 Protection against rotation
- 3 2 in case of disc seat valve
4 in case of piston valve
- 4 4 in case of disc seat valve
2 in case of piston valve
- 5 3 in case of disc seat valve
5 in case of piston valve
- 6 5 in case of disc seat valve
3 in case of piston valve

Pneumatic connection	B1	B2	B3	B4	B5	B6	B7	B8	B9	B10	D1	D2	D3	D4	D5	H1	H2
G1/8	26	16.5	18	13	16.5	5	13	9.5	8	19.5	G1/8	G1/8	M5	4.5	4.3	77	59.5
G1/4	32	19.5	22	16	19.5	6	16	12.5	9	24	G1/4			5.5	4.3	88	68

Pneumatic connection	H3	H4	H5	H6	H7	H8	H9	H10	H11	H12	H13	H14	L1	L2	L3	L4
G1/8	49.5	38.5	27.5	17.5	19	38.5 ±0.2	21	41	12	12	8.5	9	47 ±0.2	43	3.5	40
G1/4	56	44	32	20	20	44	22	48	16	16	12		53	49	4.5	44

Solenoid valves MFH-B, Tiger 2000

Technical data – 5/3-way valves



Dimensions – Pneumatic connection G1/8, G1/4

Download CAD data → www.festo.com

Installation dimensions with F solenoid coil, mechanical or pneumatic reset

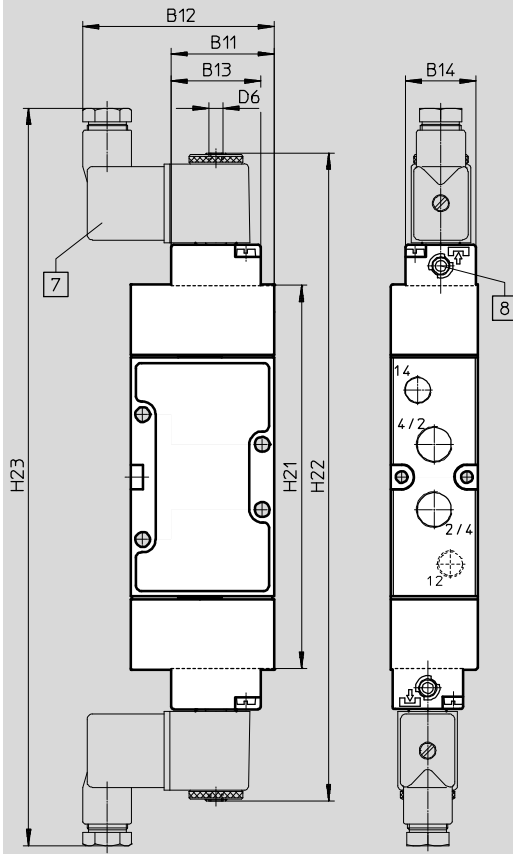

- 7 Solenoid coil can be rotated by 360°
- 8 Manual override can be turned by 180°

Type	B11	B12	B13	B14	D6	H21	H22	H23
MFH-5-1/8-	36.8	67	33	26	M5	129	226.6	259.6
MFH-5-1/4-	38	70				141.5	239.1	272.1

Solenoid valves MFH-B, Tiger 2000

Technical data – 5/3-way valves

Dimensions – Pneumatic connection G3/8

Download CAD data → www.festo.com

Basic valve

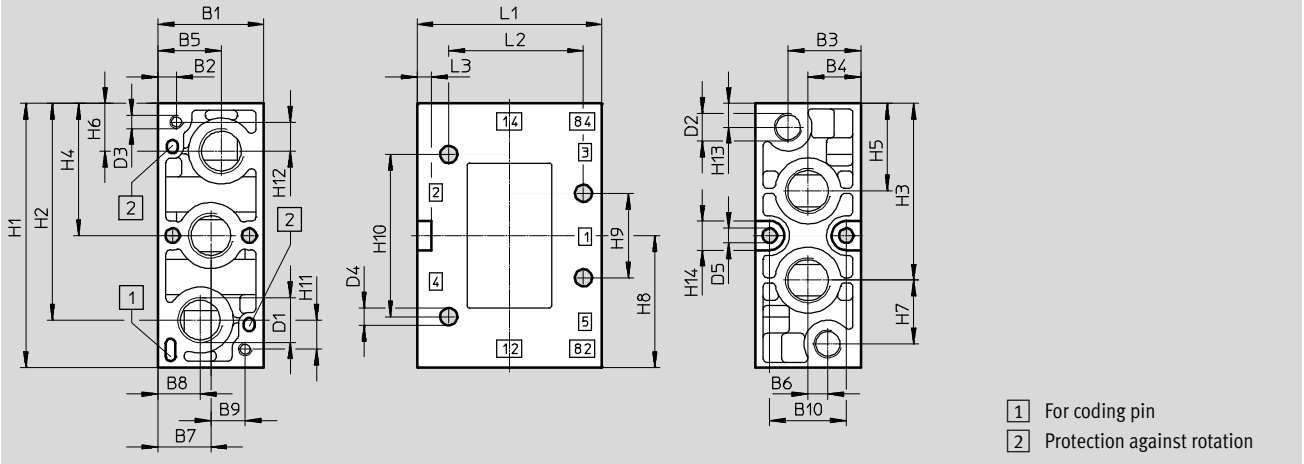

Pneumatic connection	B1 ±0.1	B2	B3	B4	B5	B6	B7	B8	B9	B10	D1 ∅	D2 ∅	D3	D4 ∅	D5
G3/8	40	13	27.5	20	24	7.6	20	16	13	29	G3/8	G1/8	M5	6.5	5.5

Pneumatic connection	H1 ±0.1	H2	H3	H4	H5	H6	H7	H8	H9	H10	H11	H12	H13	H14	L1 ±0.2	L2	L3
G3/8	100	82	66.9	50	33.1	18	24.1	50	32	61.4	11	11	9	11	70	51	5.5

Installation dimensions with F solenoid coil, mechanical or pneumatic reset

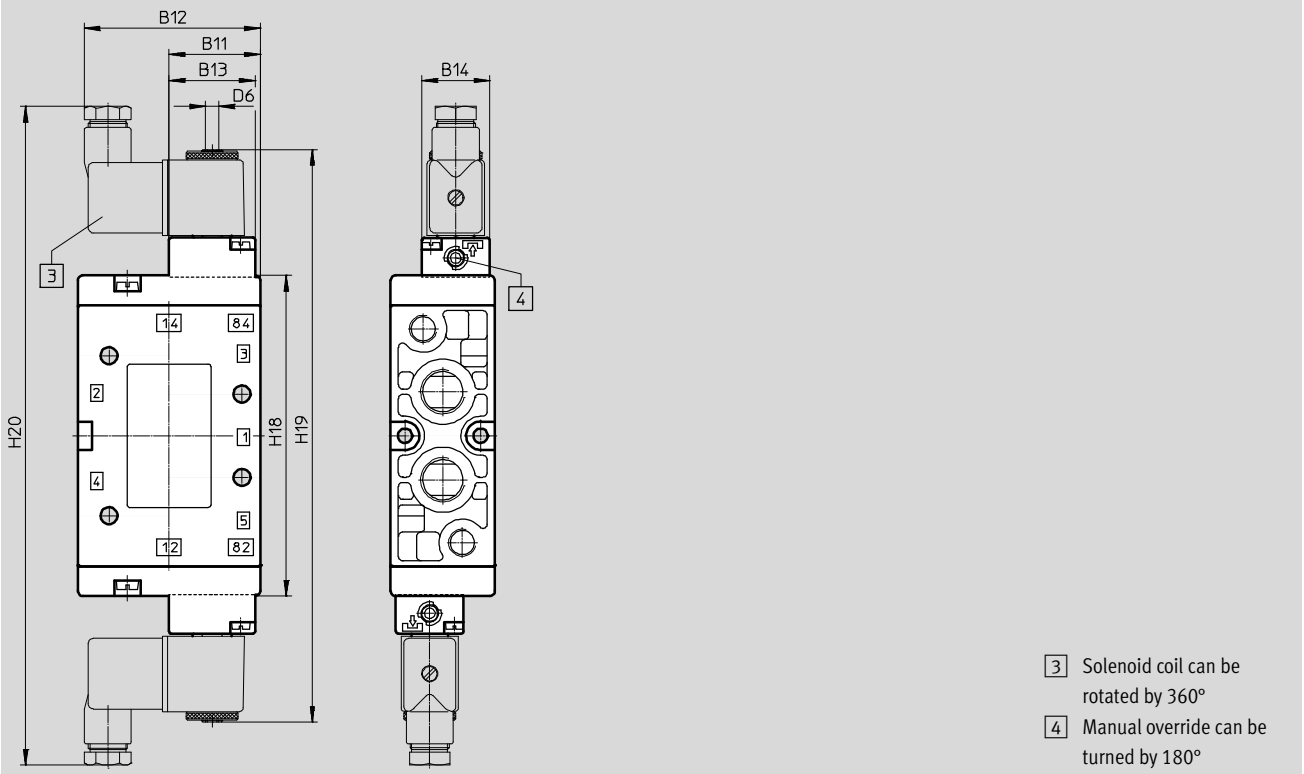

Type	B11	B12	B13	B14	D6	H18	H19	H20
JMFH-5-3/8-	35	67.5	33	26	M5	123	220	253

Solenoid valves MFH-B, Tiger 2000

Technical data – 5/3-way valves

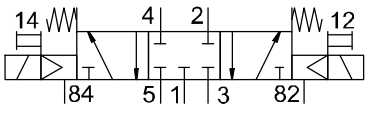
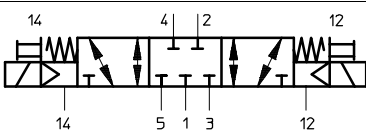
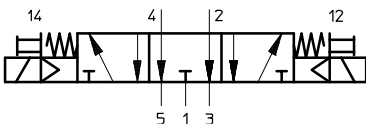
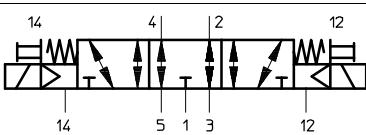
Ordering data					
Circuit symbol	Description of valve (without F solenoid coil ¹⁾)	Pneumatic connection	ATEX category	Part No.	Type
	Normally closed Internal pilot air supply	G1/8	–	30484	MFH-5/3G-1/8-B
			ATEX category →24	535936	MFH-5/3G-1/8-B-EX
		G1/4	–	19787	MFH-5/3G-1/4-B
			ATEX category →24	535937	MFH-5/3G-1/4-B-EX
		G3/8	–	19707	MFH-5/3G-3/8-B
			ATEX category →24	535938	MFH-5/3G-3/8-B-EX
	Normally closed External pilot air supply	G1/8	–	30993	MFH-5/3G-1/8-S-B
			ATEX category →24	535939	MFH-5/3G-1/8-S-B-EX
		G1/4	–	31001	MFH-5/3G-1/4-S-B
			ATEX category →24	535940	MFH-5/3G-1/4-S-B-EX
		G3/8	–	31317	MFH-5/3G-3/8-S-B
			ATEX category →24	535941	MFH-5/3G-3/8-S-B-EX
	Normally exhausted Internal pilot air supply	G1/8	–	30483	MFH-5/3E-1/8-B
			ATEX category →24	535942	MFH-5/3E-1/8-B-EX
		G1/4	–	19786	MFH-5/3E-1/4-B
			ATEX category →24	535943	MFH-5/3E-1/4-B-EX
		G3/8	–	19708	MFH-5/3E-3/8-B
			ATEX category →24	535944	MFH-5/3E-3/8-B-EX
	Normally exhausted External pilot air supply	G1/8	–	30994	MFH-5/3E-1/8-S-B
			ATEX category →24	535945	MFH-5/3E-1/8-S-B-EX
		G1/4	–	31002	MFH-5/3E-1/4-S-B
			ATEX category →24	535946	MFH-5/3E-1/4-S-B-EX
		G3/8	–	31318	MFH-5/3E-3/8-S-B
			ATEX category →24	535947	MFH-5/3E-3/8-S-B-EX

1) F solenoid coils → 71

Solenoid valves MFH-B, Tiger 2000

Technical data – 5/3-way valves

Ordering data					
Circuit symbol	Description of valve (without F solenoid coil ¹⁾)	Pneumatic connection	ATEX category	Part No.	Type
	Normally pressurised Internal pilot air supply	G1/8	–	30485	MFH-5/3B-1/8-B
			ATEX category →24	535948	MFH-5/3B-1/8-B-EX
		G1/4	–	19788	MFH-5/3B-1/4-B
			ATEX category →24	535949	MFH-5/3B-1/4-B-EX
		G3/8	–	19709	MFH-5/3B-3/8-B
			ATEX category →24	535950	MFH-5/3B-3/8-B-EX
	Normally pressurised External pilot air supply	G1/8	–	30995	MFH-5/3B-1/8-S-B
			ATEX category →24	535951	MFH-5/3B-1/8-S-B-EX
		G1/4	–	31003	MFH-5/3B-1/4-S-B
			ATEX category →24	535952	MFH-5/3B-1/4-S-B-EX
		G3/8	–	31319	MFH-5/3B-3/8-S-B
			ATEX category →24	535953	MFH-5/3B-3/8-S-B-EX

1) F solenoid coils → 71

Solenoid valves MVH-B, Tiger 2000

Technical data – 5/2-way valves

-  - Flow rate
750 ... 2000 l/min

-  - Voltage
24 V DC

Wearing parts kits
→ 38



General technical data						
Pneumatic connection	G1/8		G1/4		G3/8	
Reset method	Mechanical	Pneumatic	Mechanical	Pneumatic	Mechanical	Pneumatic
Valve function	5/2-way, single solenoid					
Design	Poppet seat	Piston spool	Poppet seat	Piston spool	Piston spool	
Lap	Underlap	Overlap	Underlap	Overlap	Overlap	
Sealing principle	Soft					
Actuation type	Electrical					
Control type	Pilot-actuated					
Pilot air supply	Internal or external					
Flow direction	Reversible or non-reversible (see switching symbol)					
Exhaust air function	With flow control					
Manual override	Non-detenting					
Mounting type	With through-hole					
Mounting position	Any					
b value	0.34	–	0.29	0.38	–	–
c value	[l/s bar]	3	–	5.5	6.35	–
Nominal width	[mm]	5	8	7	10	12
Standard flow rate	[l/min.]	750	1000	1300	1600	2000
Grid dimension	[mm]	27		33		41
Valve width	[mm]	26		32		40
Product weight	[g]	230	290	360	440	750

Safety data		
Max. switching frequency	[Hz]	3
Max. positive test pulse with 0 signal	[µs]	2200
Max. negative test pulse with 1 signal	[µs]	3700

Solenoid valves MVH-B, Tiger 2000

Technical data – 5/2-way valves

Operating and environmental conditions								
Pneumatic connection		G1/8		G1/4		G3/8		
Reset method		Mechanical	Pneumatic	Mechanical	Pneumatic	Mechanical	Pneumatic	
Operating medium		Compressed air to ISO 8573-1:2010 [7:4:4]						
Pilot medium (with external pilot air supply)		Compressed air to ISO 8573-1:2010 [7:4:4]						
Note on operating/pilot medium		Operation with lubricated medium possible (in which case lubricated operation will always be required)						
Operating pressure	Internal pilot air supply	[bar]	2 ... 10	3 ... 10	2 ... 10	3 ... 10	2.5 ... 10	2 ... 10
	External pilot air supply	[bar]	0 ... 10	-0.9 ... +10	0 ... 10	-0.9 ... +10	-0.9 ... +10	-0.9 ... +10
Pilot pressure		[bar]	2 ... 10	3 ... 10	1.5 ... 10	3 ... 10	2.5 ... 10	2 ... 10
Storage temperature		[°C]	-40 ... +60					
Ambient temperature		[°C]	-5 ... +50					
Temperature of medium		[°C]	-5 ... +50					
Corrosion resistance class CRC ¹⁾			1					

1) Corrosion resistance class CRC 1 to Festo standard FN 940070

Low corrosion stress. For dry indoor applications or transport and storage protection. Also applies to parts behind covers, in the non-visible interior area, and parts which are covered in the application (e.g. drive trunnions).

Electrical			
V solenoid coil			
Electrical connection		To EN 175301-803, type B	
Permissible voltage fluctuations		[%]	± 10
Operating voltage	DC voltage	[V DC]	24
Characteristic coil data	DC voltage	[W]	2.5
Degree of protection to EN 60529		IP65 (in combination with plug socket)	

Valve switching times [ms]						
Type	MVH-5-1/8-B	MVH-5-1/8-L-B	MVH-5-1/4-B	MVH-5-1/4-L-B	MVH-5-3/8-B	MVH-5-3/8-L-B
	MVH-5-1/8-S-B	MVH-5-1/8-L-S-B	MVH-5-1/4-S-B	MVH-5-1/4-L-S-B	MVH-5-3/8-S-B	MVH-5-3/8-L-S-B
Reset method	Mechanical	Pneumatic	Mechanical	Pneumatic	Mechanical	Pneumatic
On	20	30	15, 19	28	22	22
Off	36	25	36, 41	37	60	60

Solenoid valves MVH-B, Tiger 2000

Technical data – 5/2-way valves

FESTO

Minimal pilot pressure p_{12}/p_{14} as a function of operating pressure p_1 (external pilot air supply)

MVH-5-1/8-S-B

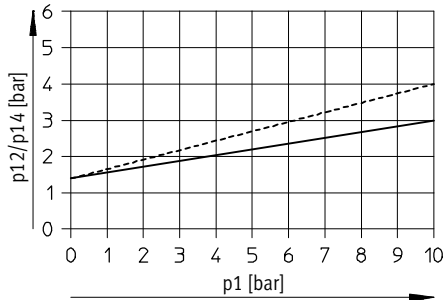

----- Exhausting, throttled
 ———— Exhausting, unthrottled

MVH-5-1/4-S-B

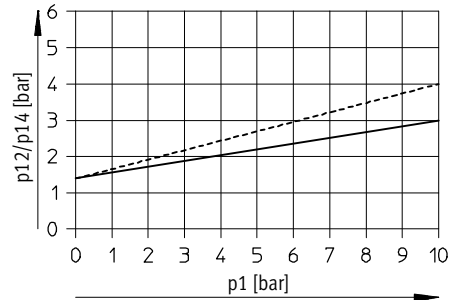

----- Exhausting, throttled
 ———— Exhausting, unthrottled

MVH-5-3/8-S-B

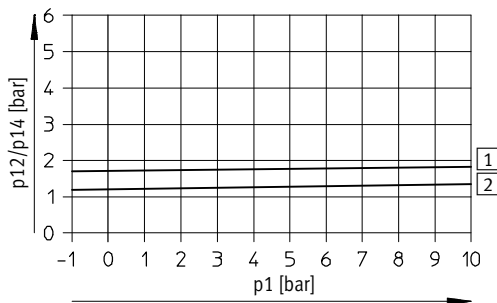

1 On
 2 Off

Materials

Sectional view

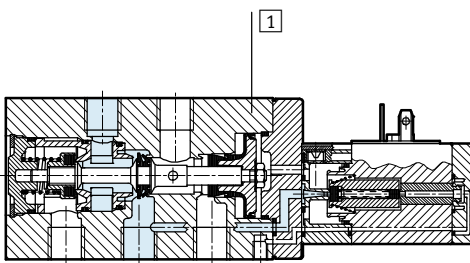

1	Housing	Die-cast aluminium
-	Seals	NBR, PU, TPE-U(PU)
-	Note on materials	RoHS compliant

Solenoid valves MVH-B, Tiger 2000

Technical data – 5/2-way valves

Dimensions – Pneumatic connection G1/8, G1/4

Download CAD data → www.festo.com

Basic valve

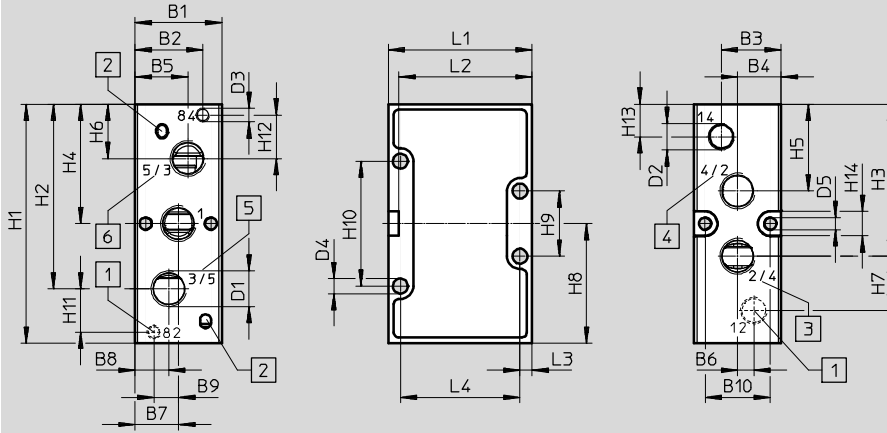

- 1 Connection 12 and 82 are not available with MFH-5-...-B and MFH-5-...-S-B
- 2 Protection against rotation
- 3 2 in case of disc seat valve
4 in case of piston valve
- 4 4 in case of disc seat valve
2 in case of piston valve
- 5 3 in case of disc seat valve
5 in case of piston valve
- 6 5 in case of disc seat valve
3 in case of piston valve

Pneumatic connection	B1	B2	B3	B4	B5	B6	B7	B8	B9	B10	D1	D2	D3	D4	D5	H1	H2
G1/8	26	16.5	18	13	16.5	5	13	9.5	8	19.5	G1/8	G1/8	M5	4.5	4.3	77	59.5
G1/4	32	19.5	22	16	19.5	6	16	12.5	9	24	G1/4			5.5	4.3	88	68

Pneumatic connection	H3	H4	H5	H6	H7	H8	H9	H10	H11	H12	H13	H14	L1	L2	L3	L4
G1/8	49.5	38.5	27.5	17.5	19	38.5 ±0.2	21	41	12	12	8.5	9	47 ±0.2	43	3.5	40
G1/4	56	44	32	20	20	44	22	48	16	16	12		53	49	4.5	44

Solenoid valves MVH-B, Tiger 2000

Technical data – 5/2-way valves



Dimensions – Pneumatic connection G1/8, G1/4

Download CAD data → www.festo.com

Installation dimensions with V solenoid coil

Mechanical reset method

Pneumatic reset method

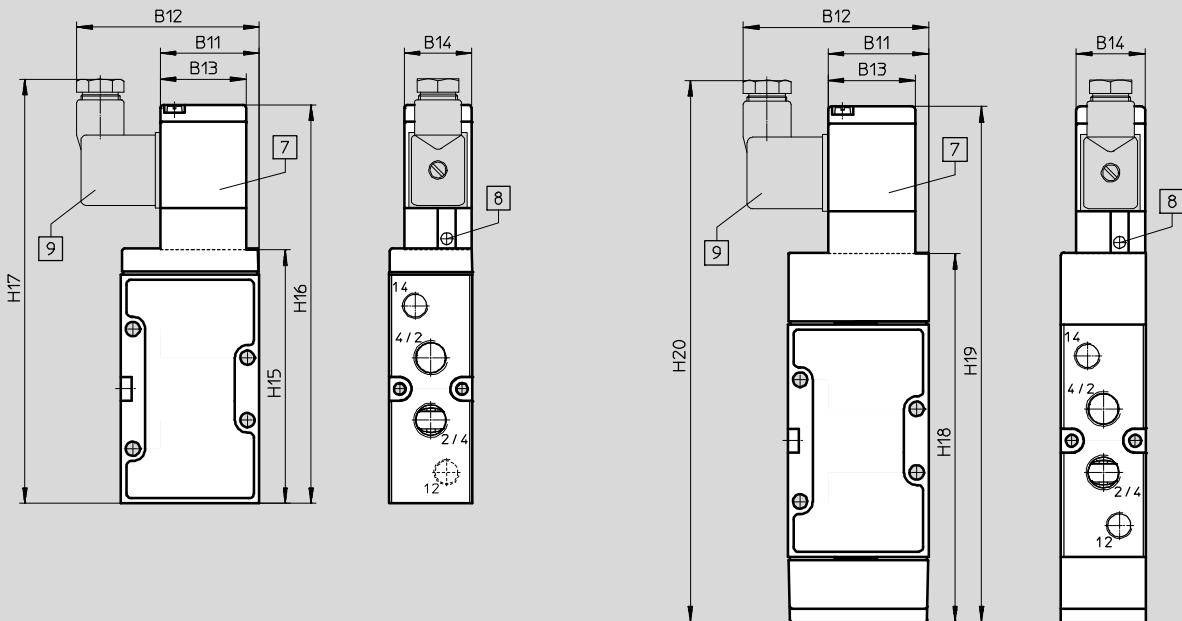

7 Solenoid coil can be rotated by 180°

8 Manual override can be turned by 180°

9 Connection for device plug to EN 175301-803, type B

Type	B11	B12	B13	B14	H15	H16	H17
MVH-5-1/8-	36.8	67	33	26	86.5	142.6	152.6
MVH-5-1/4-	38	70			97.5	153.1	163.1

Solenoid valves MVH-B, Tiger 2000

Technical data – 5/2-way valves

Dimensions – Pneumatic connection G3/8

Download CAD data → www.festo.com

Basic valve

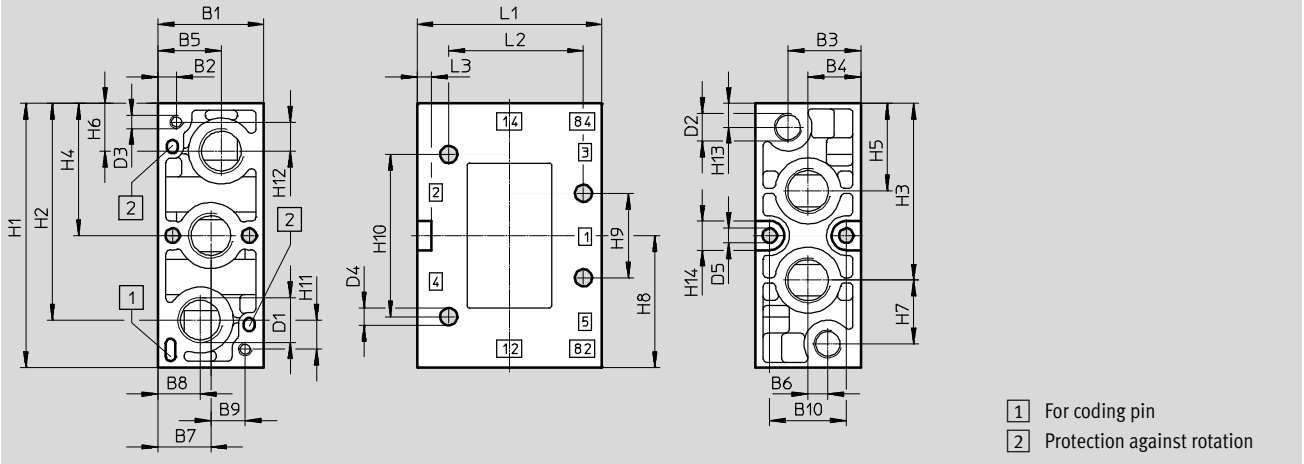

Pneumatic connection	B1 ±0.1	B2	B3	B4	B5	B6	B7	B8	B9	B10	D1 ∅	D2 ∅	D3 M5	D4 ∅	D5
G3/8	40	13	27.5	20	24	7.6	20	16	13	29	G3/8	G1/8	M5	6.5	5.5

Pneumatic connection	H1 ±0.1	H2	H3	H4	H5	H6	H7	H8	H9	H10	H11	H12	H13	H14	L1 ±0.2	L2	L3
G3/8	100	82	66.9	50	33.1	18	24.1	50	32	61.4	11	11	9	11	70	51	5.5

Installation dimensions with V solenoid coil

Mechanical or pneumatic reset

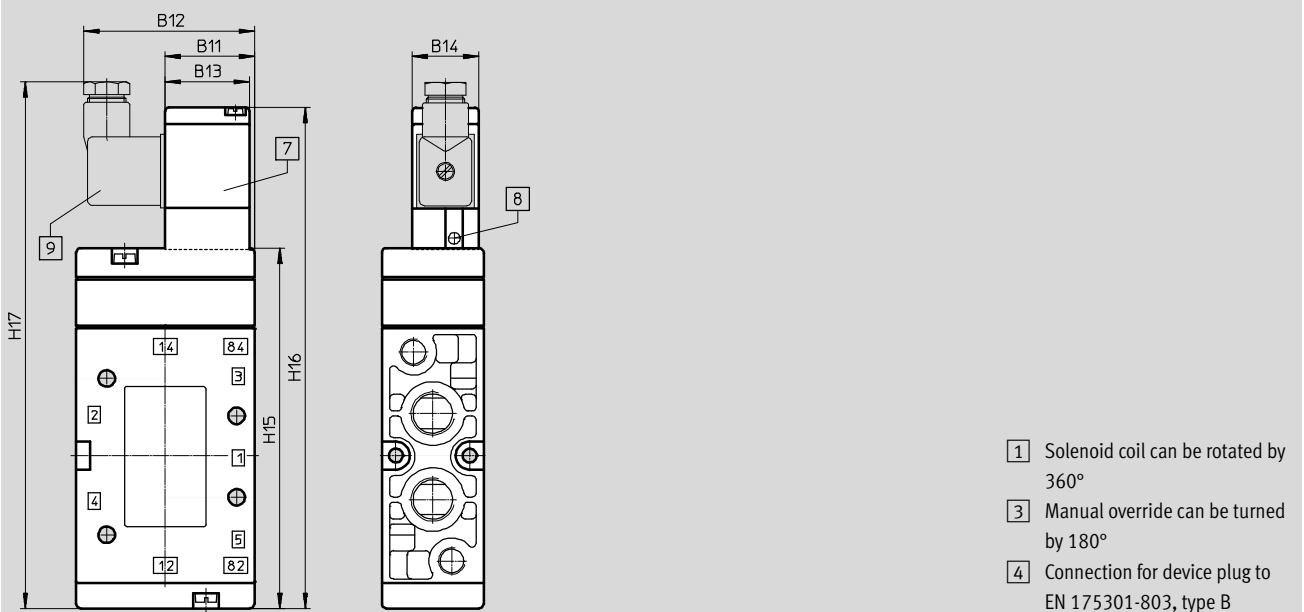

Type	B11	B12	B13	B14	H15	H16	H17
MVH-5-3/8-	35	67.5	33	26	141.5	197	207

Solenoid valves MVH-B, Tiger 2000

Technical data – 5/2-way valves

Ordering data					
Circuit symbol	Description of valves with V solenoid coil	Voltage	Pneumatic connection	Part No.	Type
	Pneumatic reset method Internal pilot air supply	24 V DC	G1/8	19749	MVH-5-1/8-L-B
			G1/4	31009	MVH-5-1/4-L-B
			G3/8	14947	MVH-5-3/8-L-B
	Pneumatic reset method External pilot air supply	24 V DC	G1/8	19750	MVH-5-1/8-L-S-B
			G1/4	33184	MVH-5-1/4-L-S-B
			G3/8	33180	MVH-5-3/8-L-S-B
	Mechanical reset method Internal pilot air supply	24 V DC	G1/8	19779	MVH-5-1/8-B
			G1/4	19701	MVH-5-1/4-B
			G3/8	14945	MVH-5-3/8-B
	Mechanical reset method External pilot air supply	24 V DC	G1/8	30996	MVH-5-1/8-S-B
			G1/4	15903	MVH-5-1/4-S-B
	Mechanical reset method External pilot air supply	24 V DC	G3/8	15342	MVH-5-3/8-S-B

Ordering data – Wearing parts kits		
Pneumatic connection	Part No.	Type
G1/8	125071	MVH-5-1/8-B
G1/4	115588	MVH-5-1/4-B
G3/8	115074	MVH-5-3/8-B

Solenoid valves JMVH-B, Tiger 2000

FESTO

Technical data – 5/2-way valves, double solenoid valves

-  - Flow rate
1000 ... 2000 l/min

-  - Voltage
24 V DC

Wearing parts kits
→ 44



General technical data			
Pneumatic connection	G1/8	G1/4	G3/8
Valve function	5/2-way, double solenoid		
Design	Piston spool		
Lap	Yes		
Sealing principle	Overlap		
Actuation type	Electrical		
Control type	Pilot-actuated		
Pilot air supply	Internal or external		
Flow direction	Reversible or non-reversible (see switching symbol)		
Exhaust air function	With flow control		
Manual override	Non-detenting		
Mounting type	With through-hole		
Mounting position	Any		
b value	–	0.38	–
c value	[l/s bar]	–	6.35
Nominal width	[mm]	8	10
Standard flow rate	[l/min.]	1000	1600
Grid dimension	[mm]	27	33
Valve width	[mm]	26	32
Product weight	[g]	560	615

Safety data		
Max. switching frequency	[Hz]	3
Max. positive test pulse with 0 signal	[µs]	2200
Max. negative test pulse with 1 signal	[µs]	3700

Operating and environmental conditions			
Pneumatic connection	G1/8	G1/4	G3/8
Operating medium	Compressed air to ISO 8573-1:2010 [7:4:4]		
Pilot medium (with external pilot air supply)	Compressed air to ISO 8573-1:2010 [7:4:4]		
Note on operating/pilot medium	Operation with lubricated medium possible (in which case lubricated operation will always be required)		
Operating pressure	Internal pilot air supply	[bar]	2 ... 10
	External pilot air supply	[bar]	–0.9 ... +10
Pilot pressure	[bar]	2 ... 10	2 ... 10
Storage temperature	[°C]	–40 ... +60	
Ambient temperature	[°C]	–5 ... +50	
Temperature of medium	[°C]	–5 ... +50	
Corrosion resistance class CRC ¹⁾	1		

1) Corrosion resistance class CRC 1 to Festo standard FN 940070
Low corrosion stress. For dry indoor applications or transport and storage protection. Also applies to parts behind covers, in the non-visible interior area, and parts which are covered in the application (e.g. drive trunnions).

Solenoid valves JMVH-B, Tiger 2000

Technical data – 5/2-way valves, double solenoid valves



Electrical			
V solenoid coil			
Electrical connection		To EN 175301-803, type B	
Permissible voltage fluctuations		[%]	± 10
Operating voltage		DC voltage	[V DC]
Characteristic coil data		DC voltage	[W]
Degree of protection to EN 60529		IP65 (in combination with plug socket)	

Valve switching times [ms]			
Type	JMVH-5-1/8-B JMVH-5-1/8-S-B	JMVH-5-1/4-B JMVH-5-1/4-S-B	JMVH-5-3/8-B JMVH-5-3/8-S-B
Changeover	18	16	17

Minimal pilot pressure p12/p14 as a function of operating pressure p1 (external pilot air supply)

JMVH-5-1/8-S-B

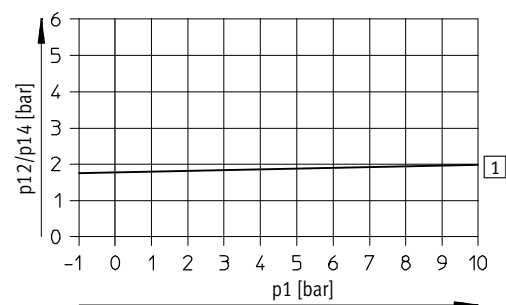

1 On

JMVH-5-1/4-S-B

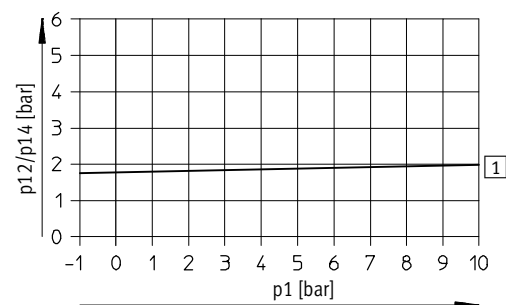

1 On

JMVH-5-3/8-S-B

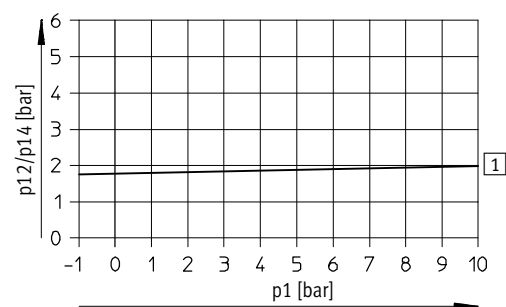

1 On

Solenoid valves JMVH-B, Tiger 2000

Technical data – 5/2-way valves, double solenoid valves

Materials

Sectional view

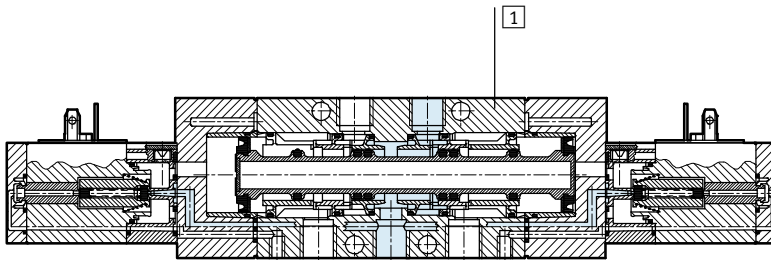

1	Housing	Die-cast aluminium
-	Seals	NBR
-	Note on materials	RoHS compliant

Dimensions – Pneumatic connection G1/8, G1/4

Download CAD data → www.festo.com

Basic valve

- 1 Connection 12 and 82 are not available with MFH-5-...-B and MFH-5-...-S-B
- 2 Protection against rotation
- 3 2 in case of disc seat valve
4 in case of piston valve
- 4 4 in case of disc seat valve
2 in case of piston valve
- 5 3 in case of disc seat valve
5 in case of piston valve
- 6 5 in case of disc seat valve
3 in case of piston valve

Pneumatic connection	B1	B2	B3	B4	B5	B6	B7	B8	B9	B10	D1 Ø	D2 Ø	D3	D4 Ø	D5	H1 ±0.2	H2
G1/8	26	16.5	18	13	16.5	5	13	9.5	8	19.5	G1/8	G1/8	M5	4.5	4.3	77	59.5
G1/4	32	19.5	22	16	19.5	6	16	12.5	9	24	G1/4			5.5	4.3	88	68

Pneumatic connection	H3	H4	H5	H6	H7	H8 ±0.2	H9	H10	H11	H12	H13	H14	L1 ±0.2	L2	L3	L4
G1/8	49.5	38.5	27.5	17.5	19	38.5	21	41	12	12	8.5	9	47	43	3.5	40
G1/4	56	44	32	20	20	44	22	48	16	16	12		53	49	4.5	44

Solenoid valves JMVH-B, Tiger 2000

Technical data – 5/2-way valves, double solenoid valves

Dimensions – Pneumatic connection G1/8, G1/4

Download CAD data → www.festo.com

Installation dimensions with V solenoid coil

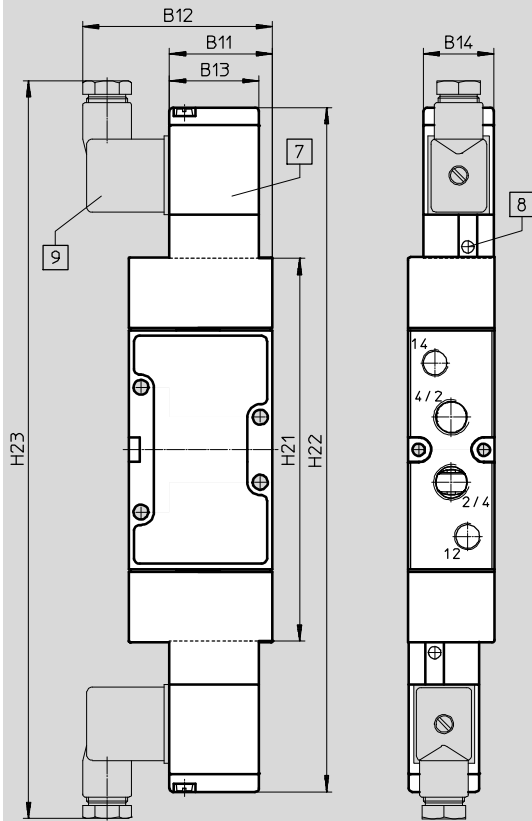

- 7 Solenoid coil can be rotated by 360°
- 8 Manual override can be turned by 180°
- 9 Connection for device plug to EN 175301-803, type B

Type	B11	B12	B13	B14	H21	H22	H23
JMVH-5-1/8-	36.8	67	33	26	129	241.2	261.2
JMVH-5-1/4-	38	70			141	254.2	274.5

Solenoid valves JMVH-B, Tiger 2000

Technical data – 5/2-way valves, double solenoid valves

Dimensions – Pneumatic connection G3/8

Download CAD data → www.festo.com

Basic valve

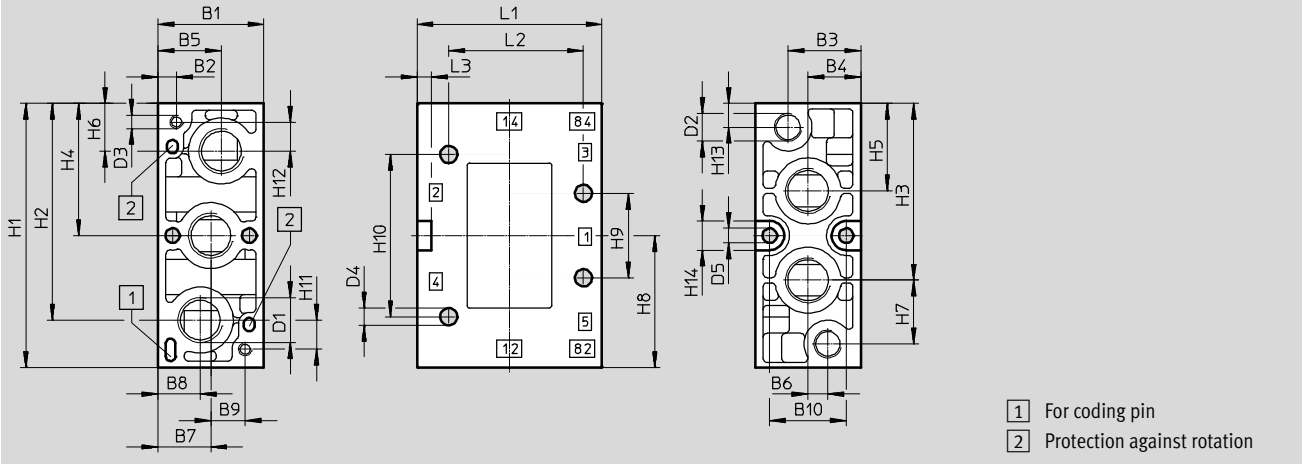

Pneumatic connection	B1 ±0.1	B2	B3	B4	B5	B6	B7	B8	B9	B10	D1 ∅	D2 ∅	D3 M5	D4 ∅	D5
G3/8	40	13	27.5	20	24	7.6	20	16	13	29	G3/8	G1/8	M5	6.5	5.5

Pneumatic connection	H1 ±0.1	H2	H3	H4	H5	H6	H7	H8	H9	H10	H11	H12	H13	H14	L1 ±0.2	L2	L3
G3/8	100	82	66.9	50	33.1	18	24.1	50	32	61.4	11	11	9	11	70	51	5.5

Installation dimensions with V solenoid coil

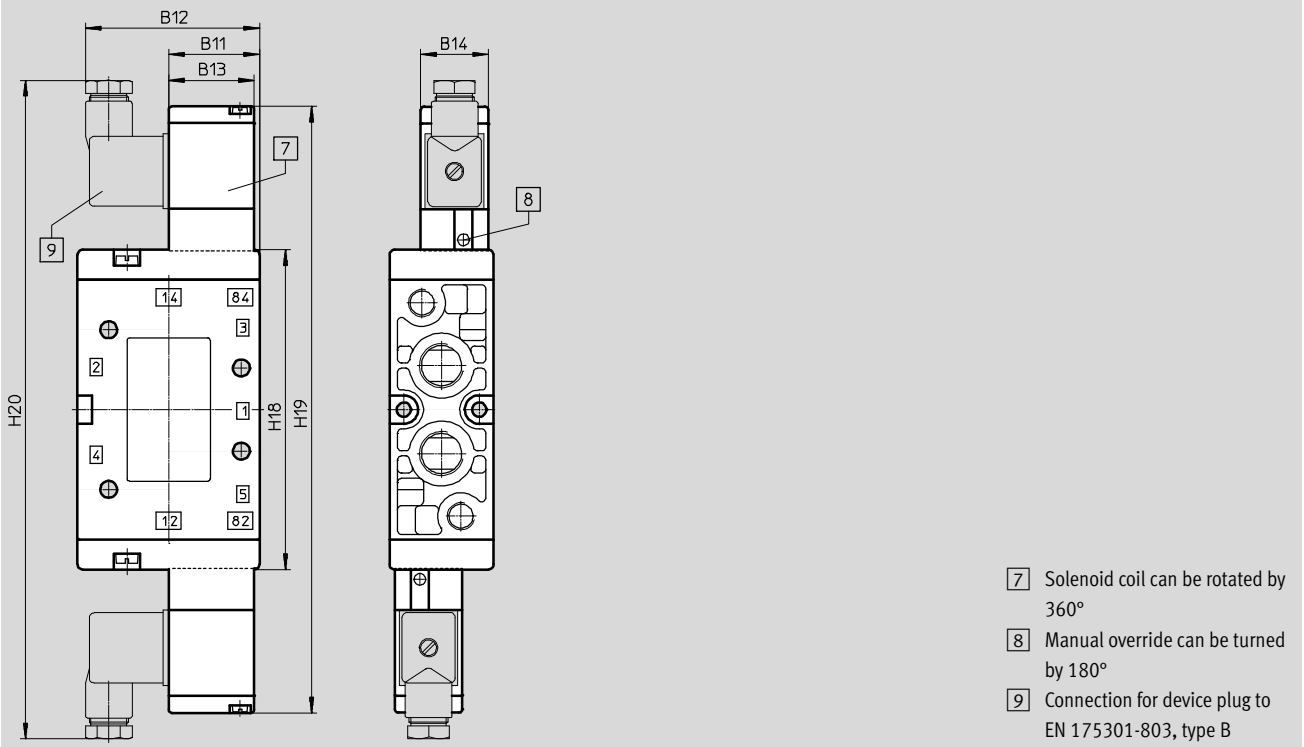

Type	B11	B12	B13	B14	H18	H19	H20
JMVH-5-3/8-	35	67.5	33	26	123	234	254

Solenoid valves JMVH-B, Tiger 2000

Technical data – 5/2-way valves, double solenoid valves

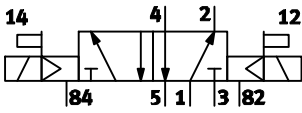
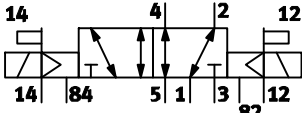
Ordering data					
Circuit symbol	Description of valves with V solenoid coil	Voltage	Pneumatic connection	Part No.	Type
 <p>The circuit symbol shows a 5/2-way valve with two solenoid coils. The top coil is connected to port 14, and the bottom coil is connected to port 12. The valve has ports 1, 2, 3, 4, 5, 8, and 82. Arrows indicate the flow of air from the solenoid coils to the valve ports.</p>	Internal pilot air supply	24 V DC	G1/8	30475	JMVH-5-1/8-B
			G1/4	19136	JMVH-5-1/4-B
			G3/8	14948	JMVH-5-3/8-B
 <p>The circuit symbol is similar to the internal pilot air supply symbol, but it includes an additional port 14 on the left side of the valve, indicating an external pilot air supply connection.</p>	External pilot air supply	24 V DC	G1/8	30476	JMVH-5-1/8-S-B
			G1/4	19137	JMVH-5-1/4-S-B
			G3/8	15343	JMVH-5-3/8-S-B

Ordering data – Wearing parts kits		
Pneumatic connection	Part No.	Type
G1/8	115590	JMVH-5-1/8-B-(SB)
G1/4	115589	JMVH-5-1/4-B-(SB)

Solenoid valves MVH-B, Tiger 2000

Technical data – 5/3-way valves

-  - Flow rate
1000 ... 2600 l/min

-  - Voltage
24 V DC



General technical data					
Pneumatic connection		G1/8	G1/4	G3/8	
Valve function		5/3-way, single solenoid			
Design		Piston spool			
Lap		Overlap			
Sealing principle		Soft			
Actuation type		Electrical			
Reset method		Mechanical spring			
Control type		Pilot-actuated			
Pilot air supply		Internal or external			
Flow direction		Reversible or not reversible (see switching symbol)			
Exhaust air function		With flow control			
Manual override		Non-detenting			
Type of mounting		With through-hole			
Mounting position		Any			
b value		-	0.38	-	
c value		[l/s bar]	-	6.35	
Nominal width		[mm]	8	10	12
Nominal flow rate		Closed [l/min.]	1000	1600	2200
		Exhausted [l/min.]			2200
		Pressurised [l/min.]			2600
Grid dimension		[mm]	27	33	41
Valve width		[mm]	26	32	40
Product weight		[g]	575	660	1000, 780 ¹⁾

1) Solenoid valve MVH-5/3G-3/8-B

Safety data		
Max. switching frequency	[Hz]	3
Max. positive test pulse with 0 signal	[µs]	2200
Max. negative test pulse with 1 signal	[µs]	3700

Solenoid valves MVH-B, Tiger 2000

FESTO

Technical data – 5/3-way valves

Operating and environmental conditions				
Pneumatic connection		G1/8	G1/4	G3/8
Operating medium		Compressed air to ISO 8573-1:2010 [7:4:4]		
Pilot medium (with external pilot air supply)		Compressed air to ISO 8573-1:2010 [7:4:4]		
Note on operating/pilot medium		Operation with lubricated medium possible (in which case lubricated operation will always be required)		
Operating pressure	Internal pilot air supply [bar]	3 ... 10	3 ... 10	3 ... 10
	External pilot air supply [bar]	-0.9 ... +10	-0.9 ... +10	-0.9 ... +10
Pilot pressure [bar]		3 ... 10	3 ... 10	3 ... 10
Storage temperature [°C]		-40 ... +60		
Ambient temperature [°C]		-5 ... +50		
Temperature of medium [°C]		-5 ... +50		
Corrosion resistance class CRC ¹⁾		1		

1) Corrosion resistance class CRC 1 to Festo standard FN 940070

Low corrosion stress. For dry indoor applications or transport and storage protection. Also applies to parts behind covers, in the non-visible interior area, and parts which are covered in the application (e.g. drive trunnions).

Electrical data			
V solenoid coil			
Electrical connection		To EN 175301-803, type B	
Permissible voltage fluctuations [%]		± 10	
Operating voltage	DC voltage [V DC]	24	
Characteristic coil data	DC voltage [W]	2.5	
Protection class to EN 60 529		IP65 (in combination with plug socket)	

Valve switching times [ms]															
Pneumatic connection	G1/8						G1/4						G3/8		
	MVH-5/3...-1/8			MVH-5/3...-1/8-B-VI-X			MVH-5/3...-1/4			MVH-5/3...-1/4-B-VI-X			MVH-5/3...-3/8		
	On	Off ²⁾	Change-over	On	Off ²⁾	Change-over	On	Off ³⁾	Change-over	On	Off ³⁾	Change-over	On	Off ⁴⁾	Change-over
Closed	28	32	32	30	30	–	18 27 ¹⁾	30 37 ¹⁾	30 39 ¹⁾	27	36	–	27	89	57
Exhausted	30 34 ¹⁾	29	34 – ¹⁾	40	50	–	36	38	46	33	45	–	35	87	75
Pressurised	31	26	20	40	50	–	32	41	46	32	38	–	35	92	73

1) With external pilot air supply

2) After long electrical actuation (> 16 h), the switch-off time of 5/3-way valves can increase to max. 50 ms.

3) After long electrical actuation (> 16 h), the switch-off time of 5/3-way valves can increase to max. 100 ms.

4) After long electrical actuation (> 16 h), the switch-off time of 5/3-way valves can increase to max. 150 ms.

Solenoid valves MVH-B, Tiger 2000

Technical data – 5/3-way valves

Minimal pilot pressure p_{12}/p_{14} as a function of operating pressure p_1 (external pilot air supply)

MVH-5/3...-1/8-S-B

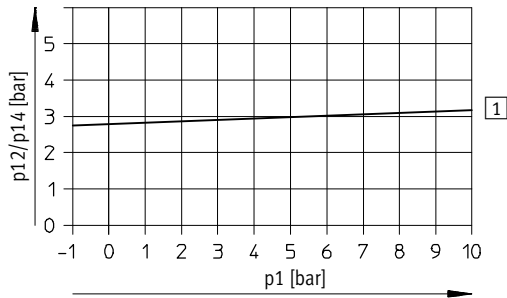

1 On

MVH-5/3...-1/4-S-B

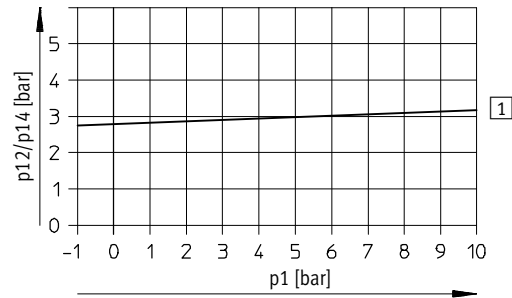

1 On

MVH-5/3...-3/8-S-B

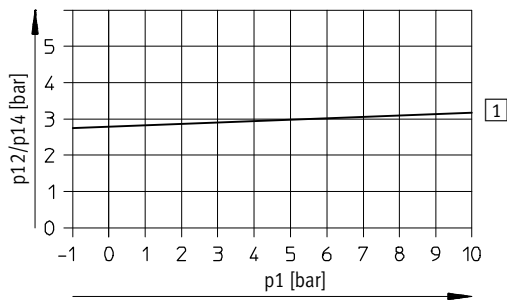

1 On

Solenoid valves MVH-B, Tiger 2000

Technical data – 5/3-way valves



Materials

Sectional view

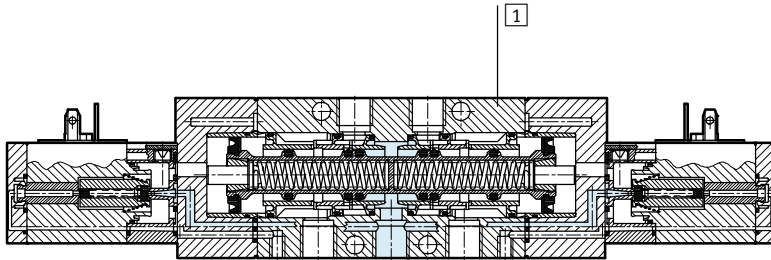

1	Housing	Die-cast aluminium
-	Seals	NBR
-	Note on materials	RoHS compliant

Dimensions – Pneumatic connection G1/8, G1/4

Download CAD data → www.festo.com

Basic valve

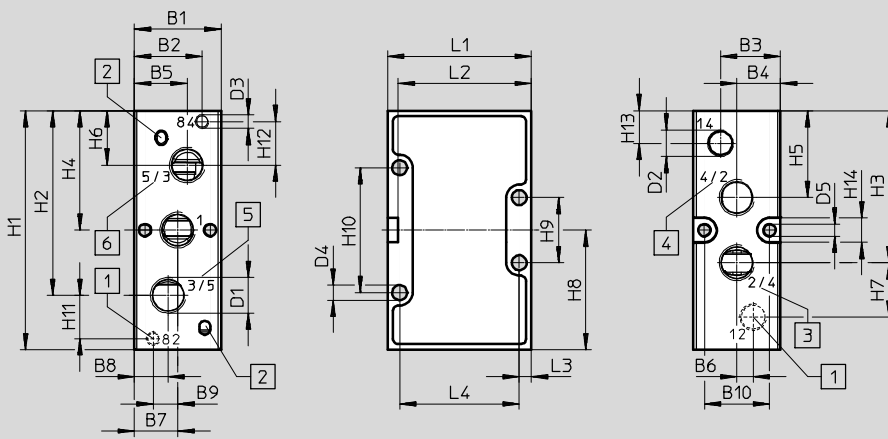

- 1 Connection 12 and 82 are not available with MFH-5-...-B and MFH-5-...-S-B
- 2 Protection against rotation
- 3 2 in case of disc seat valve
4 in case of piston valve
- 4 4 in case of disc seat valve
2 in case of piston valve
- 5 3 in case of disc seat valve
5 in case of piston valve
- 6 5 in case of disc seat valve
3 in case of piston valve

Pneumatic connection	B1	B2	B3	B4	B5	B6	B7	B8	B9	B10	D1 Ø	D2 Ø	D3	D4 Ø	D5	H1 ±0.2	H2
G1/8	26	16.5	18	13	16.5	5	13	9.5	8	19.5	G1/8	G1/8	M5	4.5	4.3	77	59.5
G1/4	32	19.5	22	16	19.5	6	16	12.5	9	24	G1/4			5.5	4.3	88	68

Pneumatic connection	H3	H4	H5	H6	H7	H8 ±0.2	H9	H10	H11	H12	H13	H14	L1 ±0.2	L2	L3	L4
G1/8	49.5	38.5	27.5	17.5	19	38.5	21	41	12	12	8.5	9	47	43	3.5	40
G1/4	56	44	32	20	20	44	22	48	16	16	12		53	49	4.5	44

Solenoid valves MVH-B, Tiger 2000

Technical data – 5/3-way valves

Dimensions

Download CAD data → www.festo.com

Installation dimensions with V solenoid coil, mechanical or pneumatic reset

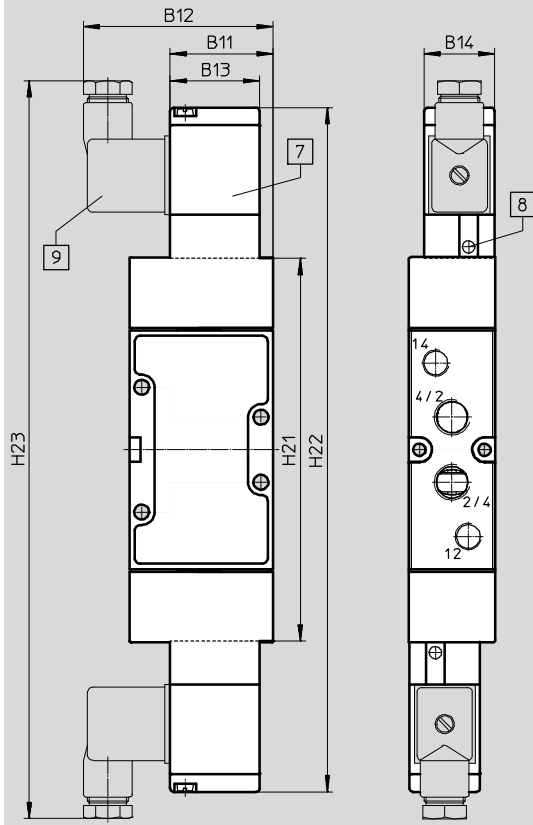

- 7 Solenoid coil can be rotated by 360°
- 8 Manual override can be turned by 180°
- 9 Connection for device plug to EN 175301-803, type B

Type	B11	B12	B13	B14	H21	H22	H23
MVH-5-1/8-	36.8	67	33	26	129	241.2	261.2
MVH-5-1/4-	38	70			141	254.2	274.5

Solenoid valves MVH-B, Tiger 2000

Technical data – 5/3-way valves

Dimensions – Pneumatic connection G3/8

Download CAD data → www.festo.com

Basic valve

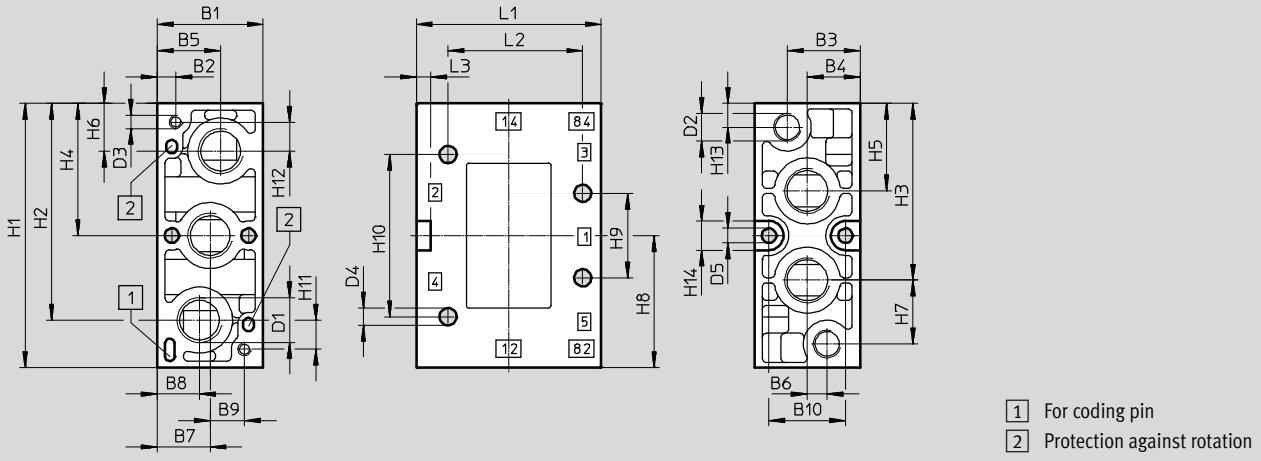

Pneumatic connection	B1 ±0.1	B2	B3	B4	B5	B6	B7	B8	B9	B10	D1 ∅	D2 ∅	D3	D4 ∅	D5
G3/8	40	13	27.5	20	24	7.6	20	16	13	29	G3/8	G1/8	M5	6.5	5.5

Pneumatic connection	H1 ±0.1	H2	H3	H4	H5	H6	H7	H8	H9	H10	H11	H12	H13	H14	L1 ±0.2	L2	L3
G3/8	100	82	66.9	50	33.1	18	24.1	50	32	61.4	11	11	9	11	70	51	5.5

Installation dimensions with V solenoid coil, mechanical or pneumatic reset

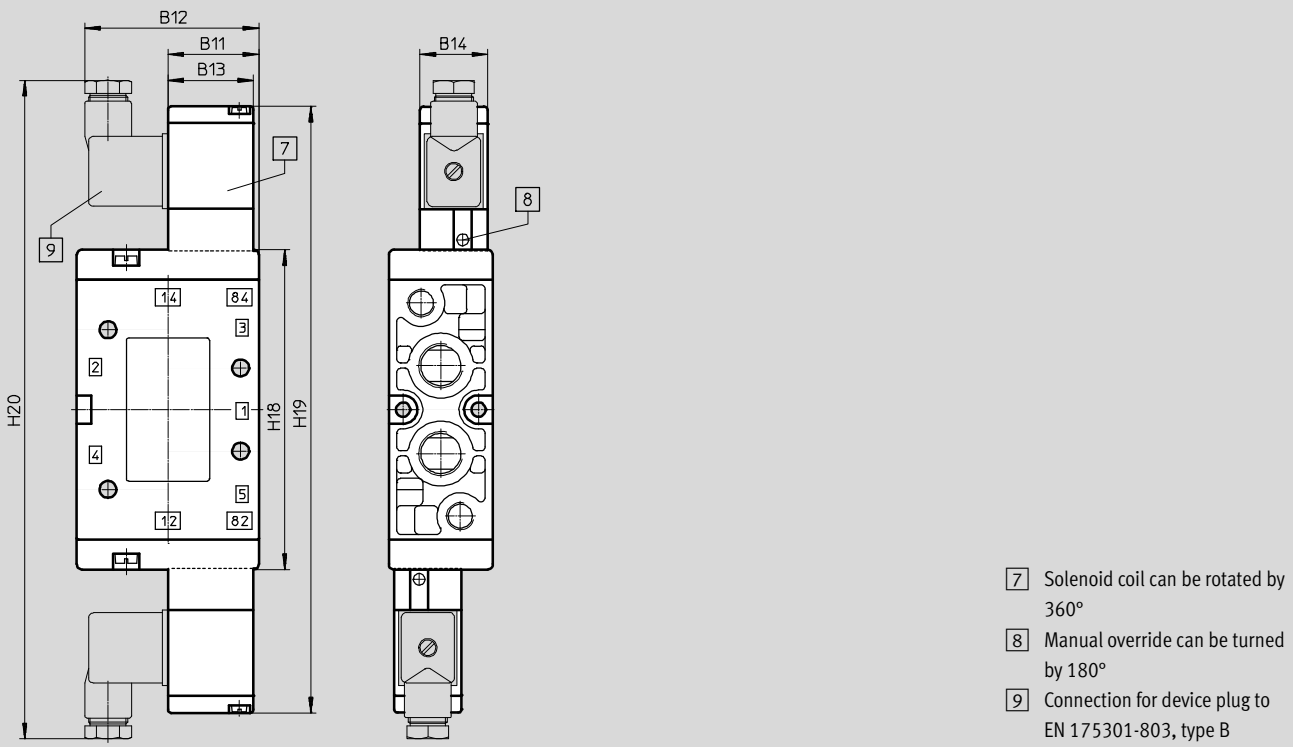

Type	B11	B12	B13	B14	H18	H19	H20
MVH-5-3/8-	35	67.5	33	26	123	234	254

Solenoid valves MVH-B, Tiger 2000

Technical data – 5/3-way valves

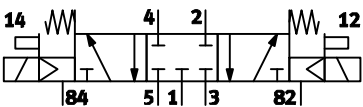
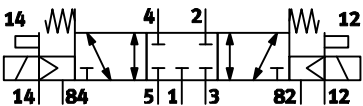
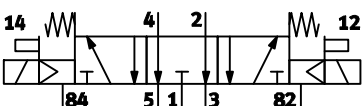
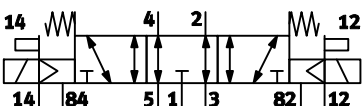
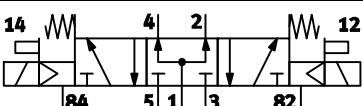
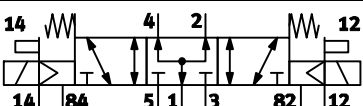
Ordering data					
Circuit symbol	Description of valves with V solenoid coil	Voltage	Pneumatic connection	Part No.	Type
	Normally closed Internal pilot air supply	24 V DC	G1/8	30477	MVH-5/3G-1/8-B
			G1/4	19138	MVH-5/3G-1/4-B
			G3/8	14944	MVH-5/3G-3/8-B
	Normally closed External pilot air supply	24 V DC	G1/8	30997	MVH-5/3G-1/8-S-B
			G1/4	31004	MVH-5/3G-1/4-S-B
			G3/8	15346	MVH-5/3G-3/8-S-B
	Normally exhausted Internal pilot air supply	24 V DC	G1/8	30478	MVH-5/3E-1/8-B
			G1/4	19139	MVH-5/3E-1/4-B
			G3/8	14943	MVH-5/3E-3/8-B
	Normally exhausted External pilot air supply	24 V DC	G1/8	30998	MVH-5/3E-1/8-S-B
			G1/4	31005	MVH-5/3E-1/4-S-B
			G3/8	15344	MVH-5/3E-3/8-S-B
	Normally pressurised Internal pilot air supply	24 V DC	G1/8	30480	MVH-5/3B-1/8-B
			G1/4	19140	MVH-5/3B-1/4-B
			G3/8	19699	MVH-5/3B-3/8-B
	Normally pressurised External pilot air supply	24 V DC	G1/8	30999	MVH-5/3B-3/8-S-B
			G1/4	31006	MVH-5/3B-1/4-S-B
			G3/8	15345	MVH-5/3B-3/8-S-B

Pneumatic valves, Tiger 2000

Peripherals overview

FESTO

Mounting on manifold block

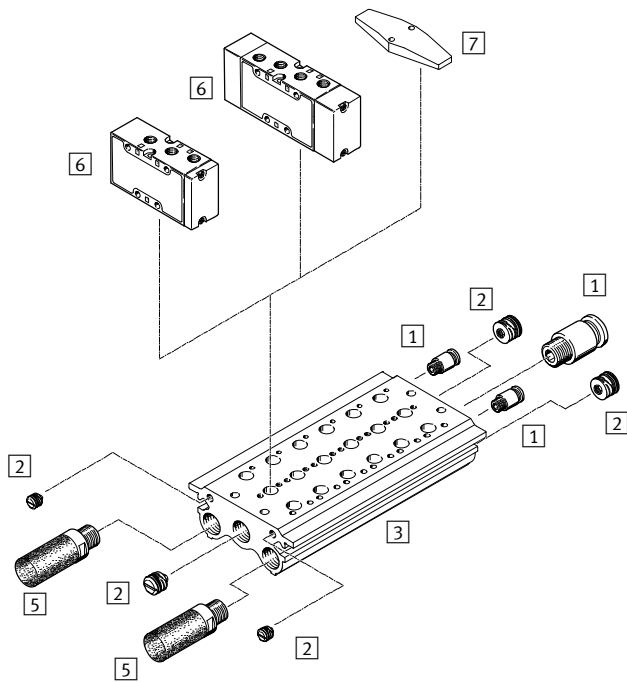

Mounting on manifold rail

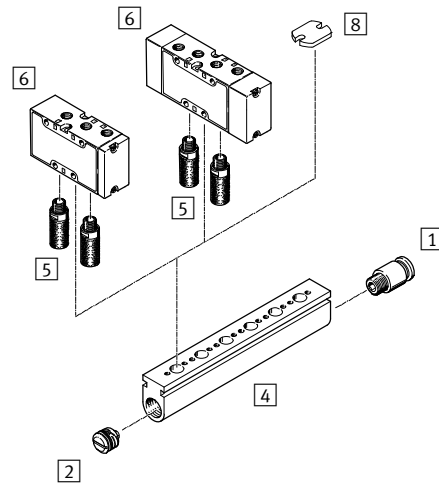

Accessories		
	Brief description	→ Page/Internet
1	Push-in fitting QS	For connecting compressed air tubing with standard outside diameters quick star
2	Blanking plug PRSV	– 70
3	Manifold block PRS	– 68
4	Manifold rail PAL	– 66
5	Silencer	For mounting in exhaust ports u
6	Pneumatic valve VL, J	– 5
7	Cover plate PRSB	For covering vacant positions 70
8	Cover plate PALB	For covering vacant positions 70

Pneumatic valves, Tiger 2000

Type codes

		VL	-	5/3	G	-	1/8	-	B	-	EX
Type											
VL	Monostable										
J	Bistable										
Valve function											
5	5/2-way valve										
5/3	5/3-way valve										
Initial position											
G	Closed										
E	Exhausted										
B	Pressurised										
Pneumatic connection											
1/8	G1/8										
1/4	G1/4										
3/8	G3/8										
Generation											
B	B series										
CE marking											
-	None										
EX	ATEX category → technical data										

Pneumatic valves VL, Tiger 2000

Technical data – 5/2-way valves

FESTO

-  - Flow rate
750 ... 2000 l/min

Wearing parts kits
→ 57



General technical data			
Pneumatic connection	G1/8	G1/4	G3/8
Valve function	5/2-way, monostable		
Design	Poppet seat		Piston spool
Lap	Underlap		Overlap
Sealing principle	Soft		
Actuation type	Pneumatic		
Reset method	Mechanical spring		
Control type	Direct		
Flow direction	Non-reversible		Reversible
Exhaust function	With flow control		
Manual override	None		
Type of mounting	With through-hole		
Mounting position	Any		
b value	–	0.29	–
c value	[l/s bar]	–	5.5
Nominal width	[mm]	5	7
Standard nominal flow rate	[l/min.]	750	1300
Grid dimension	[mm]	27	33
Valve width	[mm]	26	32
Product weight	[g]	170	240

Safety data		
Max. switching frequency	[Hz]	3
Max. positive test pulse with 0 signal	[µs]	2200
Max. negative test pulse with 1 signal	[µs]	3700

ATEX	
Type	VL- ... -EX, J- ... -EX
ATEX category gas	II 2G
Type of (ignition) protection for gas	Ex h IIC T4 Gb
ATEX category for dust	II 2D
Type of (ignition) protection for dust	Ex h IIIC T130°C Db
Explosion-proof ambient temperature	[°C] –10 °C ≤ Ta ≤ +60 °C
CE marking (see declaration of conformity)	To EU Explosion Protection Directive (ATEX)

Pneumatic valves VL, Tiger 2000

Technical data – 5/2-way valves

Operating and environmental conditions			
Pneumatic connection	G1/8	G1/4	G3/8
Operating medium	Compressed air to ISO 8573-1:2010 [7:4:4]		
Pilot medium	Compressed air to ISO 8573-1:2010 [7:4:4]		
Note on operating/pilot medium	Operation with lubricated medium possible (in which case lubricated operation will always be required)		
Operating pressure [bar]	0 ... 10	0 ... 10	-0.9 ... +10
Pilot pressure [bar]	1.5 ... 10	1.5 ... 10	2.5 ... 10
Storage temperature [°C]	-40 ... +60		
Ambient temperature [°C]	-10 ... +60		
Temperature of medium [°C]	-10 ... +60		
Corrosion resistance class CRC ¹⁾	1		

1) Corrosion resistance class CRC 1 to Festo standard FN 940070

Low corrosion stress. For dry indoor applications or transport and storage protection. Also applies to parts behind covers, in the non-visible interior area, and parts which are covered in the application (e.g. drive trunnions).

Valve switching times [ms]			
Pneumatic connection	G1/8	G1/4	G3/8
On	2	2	4
Off	10	12	16

Minimum pilot pressure p₁₂, p₁₄ as a function of the operating pressure p₁

VL-5-1/8-B

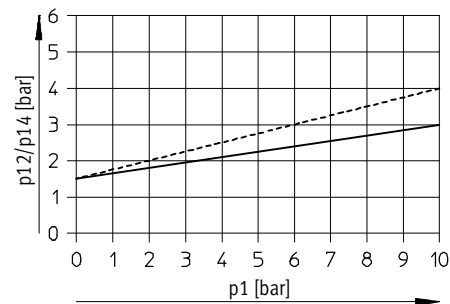

----- Exhausting, throttled
 ——— Exhausting, unthrottled

VL-5-1/4-B

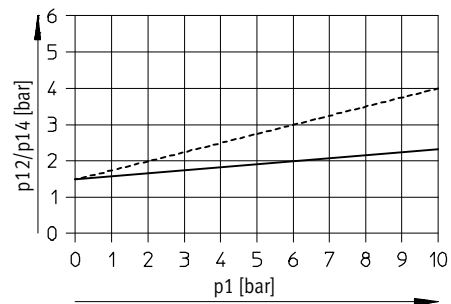

----- Exhausting, throttled
 ——— Exhausting, unthrottled

VL-5-3/8-B

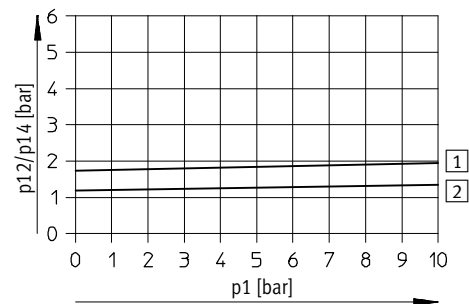

1 On
 2 Off

Pneumatic valves VL, Tiger 2000

Technical data – 5/2-way valves



Materials

Sectional view

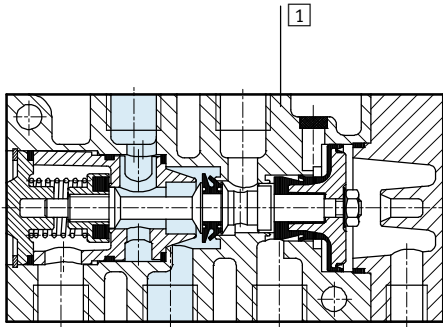

Pneumatic connection	G1/8	G1/4	G3/8
1 Housing	Die-cast aluminium		
- Seals	NBR, TPE-U(PU)		NBR
- Note on materials	RoHS compliant		

Dimensions – Pneumatic connection G1/8, G1/4

Basic valve

Download CAD data → www.festo.com

VL-5-...-B

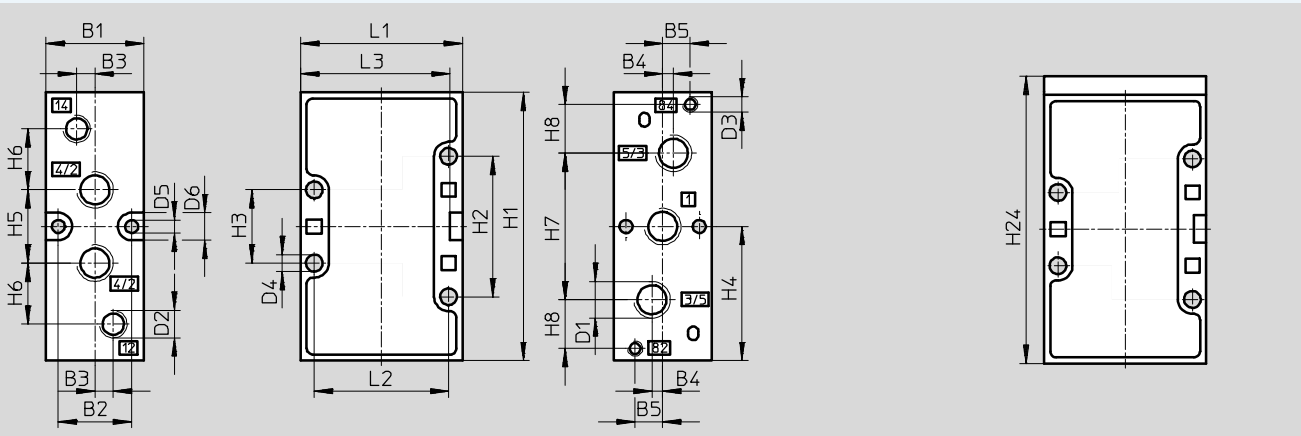

Pneumatic connection	B1	B2	B3	B4	B5	D1	D2	D3	D4	D5	D6	H1
G1/8	26	19.5	5	3.5	8	G1/8	G1/8	M5	4.5	4.3	9	77
G1/4	32	24	6	3.5	9	G1/4	G1/8	M5	5.5	4.3	9	88

Pneumatic connection	H2	H3	H4	H5	H6	H7	H8	H24	L1	L2	L3
G1/8	41	21	38.5	22	19	42	12	83	47	40	43
G1/4	46	24	44	24	20	48	16	94	53	44	49

Pneumatic valves VL, Tiger 2000

Technical data – 5/2-way valves



Dimensions – Pneumatic connection G3/8

Download CAD data → www.festo.com

Basic valve

VL-5-3/8-B

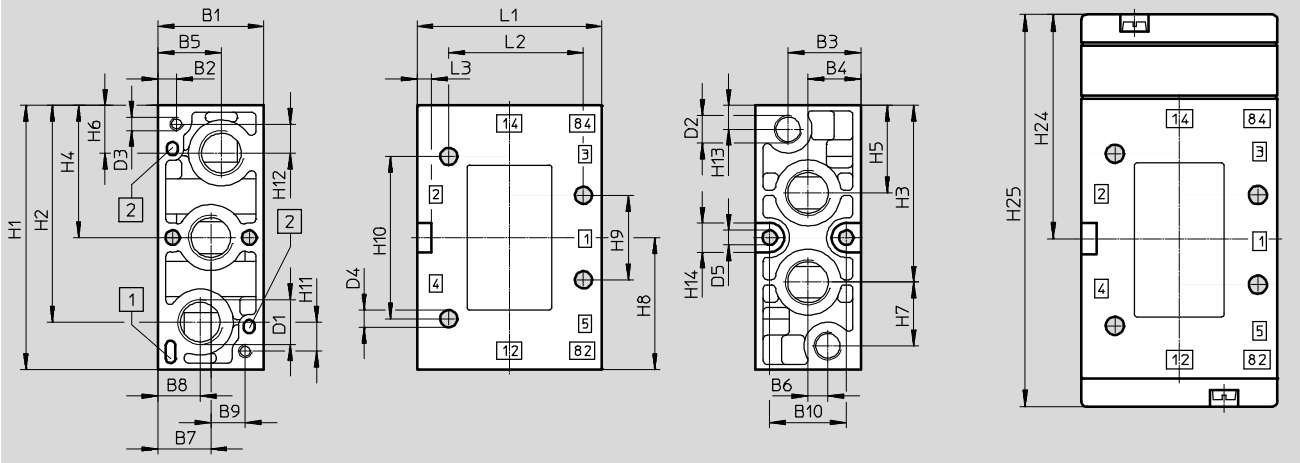

Pneumatic connection	B1 ±0.1	B2	B3	B4	B5	B6	B7	B8	B9	B10	D1	D2	D3	D4 ∅	D5 ∅	H1 ±0.1	H2
G3/8	40	13	27.5	20	24	7.6	20	16	13	29	G3/8	G1/8	M5	6.5	5.5	100	82

Pneumatic connection	H3	H4	H5	H6	H7	H8	H9	H10	H11	H12	H13	H14	H24	H25	L1 ±0.2	L2	L3
G3/8	66.9	50	33.1	18	24.1	50	32	61.4	11	11	9	11	11	11	70	51	5.5

Ordering data

Circuit symbol	Description	Pneumatic connection	ATEX category	Part No.	Type
	Mechanical reset method	G1/8	–	31000	VL-5-1/8-B
			ATEX category → 54	536040	VL-5-1/8-B-EX
	Mechanical reset method	G1/4	–	14294	VL-5-1/4-B
			ATEX category → 54	536041	VL-5-1/4-B-EX
	Mechanical reset method	G3/8	–	14952	VL-5-3/8-B
			ATEX category → 54	536042	VL-5-3/8-B-EX

Ordering data – Wearing parts kits

Pneumatic connection	Part No.	Type
G1/8	125710	VL-5-1/8-B
G1/4	115580	VL-5-1/4-B

Pneumatic valves J, Tiger 2000

Technical data – 5/2-way valves, double pilot

FESTO

-  - Flow rate
1000 ... 2000 l/min



General technical data				
Pneumatic connection		G1/8	G1/4	G3/8
Valve function		5/2-way, bistable		
Design		Piston spool		
Lap		Overlap		
Sealing principle		Soft		
Actuation type		Pneumatic		
Control type		Direct		
Flow direction		Reversible		
Exhaust function		With flow control		
Manual override		None		
Type of mounting		With through-hole		
Mounting position		Any		
b value		–	0.38	–
c value [l/s bar]		–	6.35	–
Nominal width [mm]		8	10	12
Standard nominal flow rate [l/min.]		1000	1600	2000
Grid dimension [mm]		27	33	41
Valve width [mm]		26	32	40
Product weight [g]		320	375	550

Safety data		
Max. switching frequency [Hz]		3
Max. positive test pulse with 0 signal [µs]		2200
Max. negative test pulse with 1 signal [µs]		3700

Operating and environmental conditions				
Pneumatic connection		G1/8	G1/4	G3/8
Operating medium		Compressed air to ISO 8573-1:2010 [7:4:4]		
Pilot medium		Compressed air to ISO 8573-1:2010 [7:4:4]		
Note on operating/pilot medium		Operation with lubricated medium possible (in which case lubricated operation will always be required)		
Operating pressure [bar]		–0.9 ... +10	–0.9 ... +10	–0.9 ... +10
Pilot pressure [bar]		2 ... 10	2 ... 10	2 ... 10
Storage temperature [°C]		–40 ... +60		
Ambient temperature [°C]		–10 ... +60		
Temperature of medium [°C]		–10 ... +60		
Corrosion resistance class CRC ¹⁾		1		

1) Corrosion resistance class CRC 1 to Festo standard FN 940070

Low corrosion stress. For dry indoor applications or transport and storage protection. Also applies to parts behind covers, in the non-visible interior area, and parts which are covered in the application (e.g. drive trunnions).

Pneumatic valves J, Tiger 2000

Technical data – 5/2-way valves, double pilot

Valve switching times [ms]			
Pneumatic connection	G1/8	G1/4	G3/8
Changeover	3	3	3

Minimal pilot pressure p_{12}/p_{14} as a function of operating pressure p_1

J-5-1/8-B

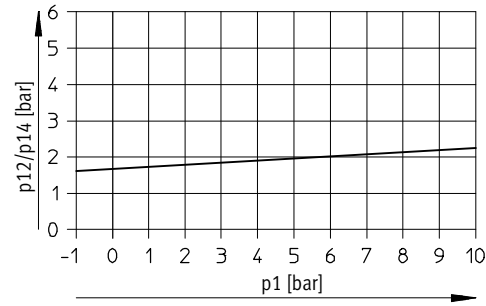

J-5-1/4-B

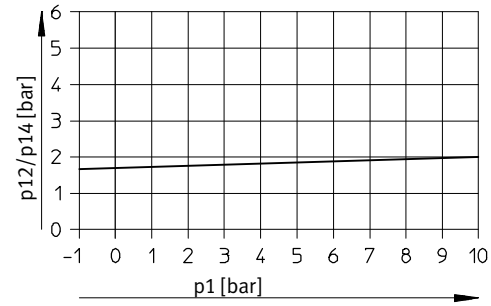

J-5-3/8-B

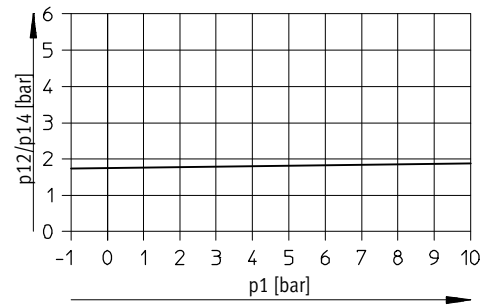

Materials

Sectional view

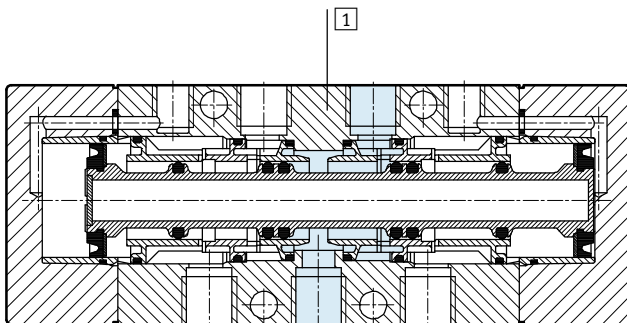

1	Housing	Die-cast aluminium
-	Seals	NBR
-	Note on materials	RoHS compliant

Pneumatic valves J, Tiger 2000

Technical data – 5/2-way valves, double pilot



Dimensions – Pneumatic connection G1/8, G1/4 Download CAD data → www.festo.com
 Basic valve J-5-...-B

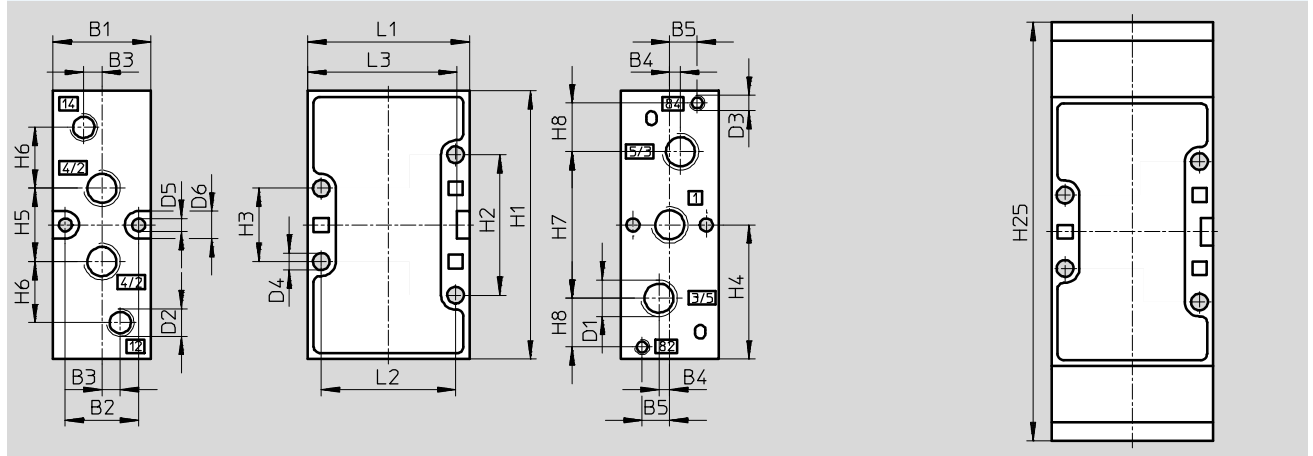

Pneumatic connection	B1	B2	B3	B4	B5	D1	D2	D3	D4	D5	D6	H1
G1/8	26	19.5	5	3.5	8	G1/8	G1/8	M5	4.5	4.3	9	77
G1/4	32	24	6	3.5	9	G1/4	G1/8	M5	5.5	4.3	9	88

Pneumatic connection	H2	H3	H4	H5	H6	H7	H8	H25	L1	L2	L3
G1/8	41	21	38.5	22	19	42	12	124	47	40	43
G1/4	46	24	44	24	20	48	16	137	53	44	49

Dimensions – Pneumatic connection G3/8 Download CAD data → www.festo.com
 Basic valve J-5-3/8-B

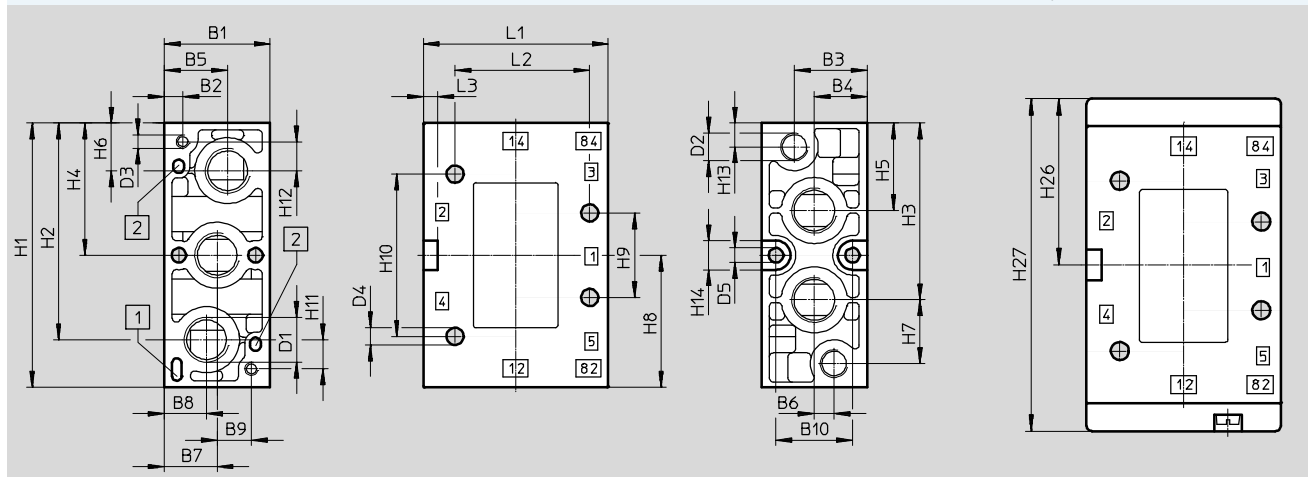

Pneumatic connection	B1	B2	B3	B4	B5	B6	B7	B8	B9	B10	D1	D2	D3	D4	D5	H1	H2
G3/8	±0.1	13	27.5	20	24	7.6	20	16	13	29	G3/8	G1/8	M5	6.5	5.5	±0.1	100

Pneumatic connection	H3	H4	H5	H6	H7	H8	H9	H10	H11	H12	H13	H14	H26	H27	L1	L2	L3
G3/8	66.9	50	33.1	18	24.1	50	32	61.4	11	11	9	11	60	120	±0.2	70	51

Pneumatic valves J, Tiger 2000

Technical data – 5/2-way valves, double pilot

Ordering data					
Circuit symbol	Description	Pneumatic connection	ATEX category	Part No.	Type
	Bistable valve	G1/8	–	30988	J-5-1/8-B
			ATEX category → 54	536043	J-5-1/8-B-EX
		G1/4	–	14295	J-5-1/4-B
			ATEX category → 54	536044	J-5-1/4-B-EX
		G3/8	–	14953	J-5-3/8-B
			ATEX category → 54	536045	J-5-3/8-B-EX

Pneumatic valves VL, Tiger 2000

Technical data – 5/3-way valves

FESTO

Flow rate
1000 ... 2000 l/min



General technical data				
Pneumatic connection		G1/8	G1/4	G3/8
Valve function		5/3-way, monostable		
Design		Piston spool		
Lap		Overlap		
Sealing principle		Soft		
Actuation type		Pneumatic		
Reset method		Mechanical spring		
Control type		Direct		
Flow direction		Reversible		
Exhaust function		With flow control		
Manual override		None		
Type of mounting		With through-hole		
Mounting position		Any		
b value		–	0.38	–
c value [l/s bar]		–	6.35	–
Nominal width [mm]		8	10	12
Standard nominal flow rate	Closed [l/min.]	1000	1600	2000
	Exhausted [l/min.]			2200
	Pressurised [l/min.]			2600
Grid dimension [mm]		27	33	41
Valve width [mm]		26	32	40
Product weight [g]		320	375	680

Safety data		
Max. switching frequency [Hz]		3
Max. positive test pulse with 0 signal [µs]		2200
Max. negative test pulse with 1 signal [µs]		3700

Operating and environmental conditions				
Pneumatic connection		G1/8	G1/4	G3/8
Operating medium		Compressed air to ISO 8573-1:2010 [7:4:4]		
Pilot medium		Compressed air to ISO 8573-1:2010 [7:4:4]		
Note on operating/pilot medium		Operation with lubricated medium possible (in which case lubricated operation will always be required)		
Operating pressure [bar]		–0.9 ... +10	–0.9 ... +10	–0.9 ... +10
Pilot pressure [bar]		3 ... 10	3 ... 10	3 ... 10
Storage temperature [°C]		–40 ... +60		
Ambient temperature [°C]		–10 ... +60		
Temperature of medium [°C]		–10 ... +60		
Corrosion resistance class CRC ¹⁾		1		

1) Corrosion resistance class CRC 1 to Festo standard FN 940070
Low corrosion stress. For dry indoor applications or transport and storage protection. Also applies to parts behind covers, in the non-visible interior area, and parts which are covered in the application (e.g. drive trunnions).

Pneumatic valves VL, Tiger 2000

Technical data – 5/3-way valves

Valve switching times [ms]			
Pneumatic connection	G1/8	G1/4	G3/8
On	5	6	7
Off	14	26	28

Minimal pilot pressure p_{12}/p_{14} as a function of operating pressure p_1

VL-5/3...-1/8-B

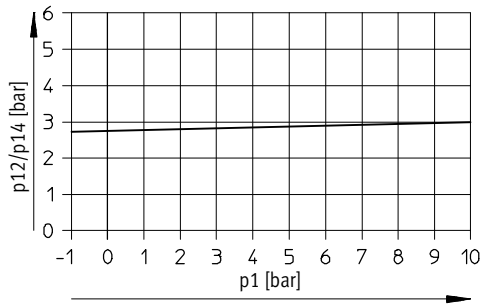

VL-5/3...-1/4-B

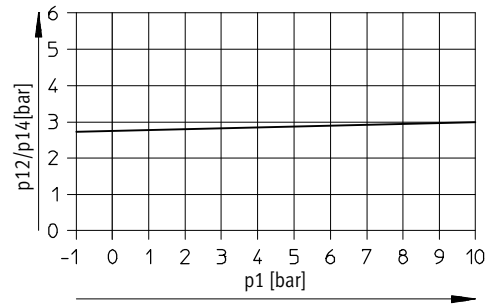

VL-5/3...-3/8-B

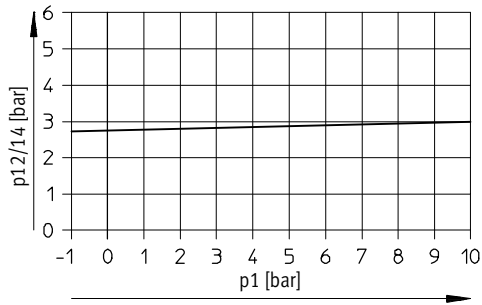

Materials

Sectional view

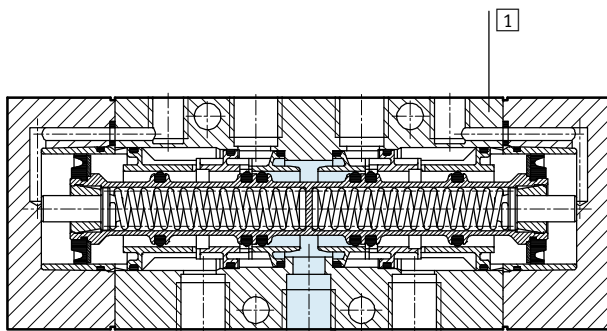

1	Housing	Die-cast aluminium
-	Seals	NBR
-	Note on materials	RoHS compliant

Pneumatic valves VL, Tiger 2000

Technical data – 5/3-way valves



Dimensions – Pneumatic connection G1/8, G1/4

Download CAD data → www.festo.com

Basic valve

VL-5/3...-B

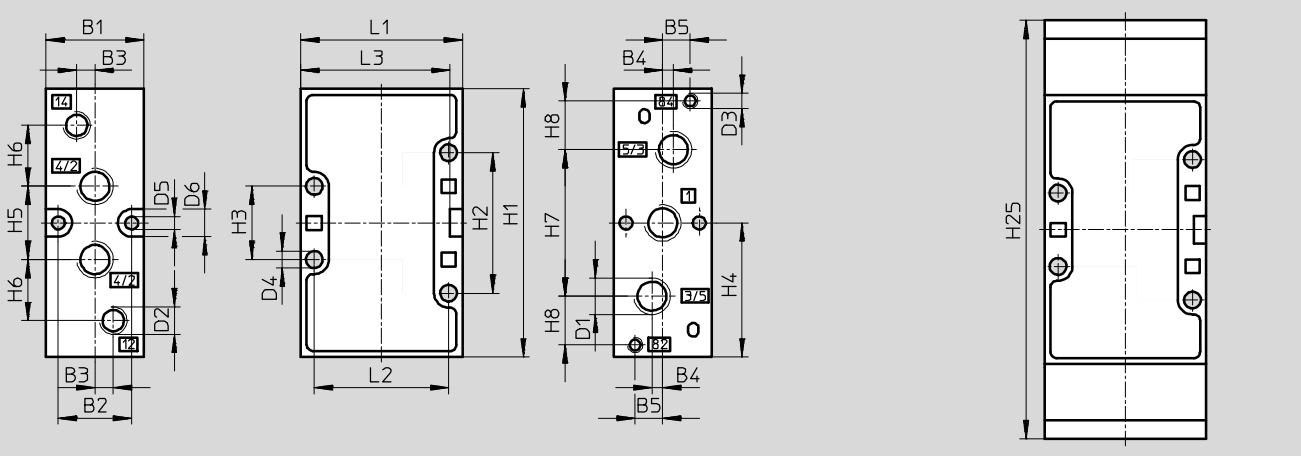

Pneumatic connection	B1	B2	B3	B4	B5	D1	D2	D3	D4	D5	D6	H1
G1/8	26	19.5	5	3.5	8	G1/8	G1/8	M5	4.5	4.3	9	77
G1/4	32	24	6	3.5	9	G1/4	G1/8	M5	5.5	4.3	9	88

Pneumatic connection	H2	H3	H4	H5	H6	H7	H8	H25	L1	L2	L3
G1/8	41	21	38.5	22	19	42	12	124	47	40	43
G1/4	46	24	44	24	20	48	16	137	53	44	49

Dimensions – Pneumatic connection G3/8

Download CAD data → www.festo.com

Basic valve

VL-5/3...-3/8-B

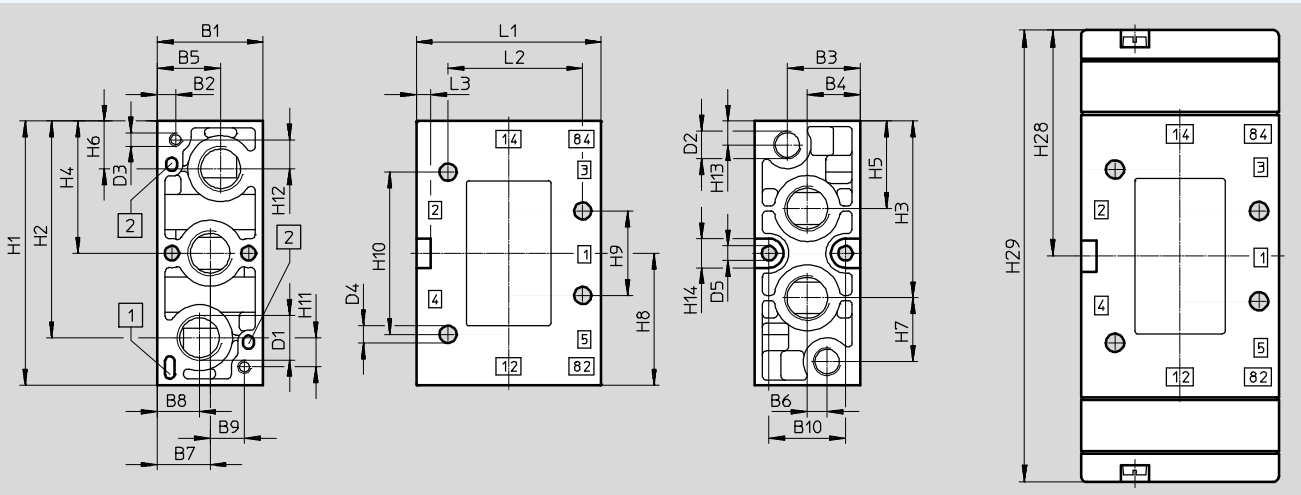

Pneumatic connection	B1	B2	B3	B4	B5	B6	B7	B8	B9	B10	D1	D2	D3	D4	D5	H1	H2
G3/8	±0.1										G3/8	G1/8	M5	6.5	5.5	±0.1	100
G3/8	40	13	27.5	20	24	7.6	20	16	13	29	G3/8	G1/8	M5	6.5	5.5	100	82

Pneumatic connection	H3	H4	H5	H6	H7	H8	H9	H10	H11	H12	H13	H14	H28	H29	L1	L2	L3	
G3/8	66.9	50	33.1	18	24.1	50	32	61.4	11	11	9	11	80	160	±0.2	70	51	5.5

Pneumatic valves VL, Tiger 2000

Technical data – 5/3-way valves

Ordering data					
Circuit symbol	Description	Pneumatic connection	ATEX category	Part No.	Type
	Normally closed	G1/8	–	30990	VL-5/3G-1/8-B
			ATEX category → 54	536046	VL-5/3G-1/8-B-EX
		G1/4	–	14298	VL-5/3G-1/4-B
			ATEX category → 54	536047	VL-5/3G-1/4-B-EX
		G3/8	–	14950	VL-5/3G-3/8-B
			ATEX category → 54	536048	VL-5/3G-3/8-B-EX
	Normally exhausted	G1/8	–	31309	VL-5/3E-1/8-B
			ATEX category → 54	536049	VL-5/3E-1/8-B-EX
		G1/4	–	14297	VL-5/3E-1/4-B
			ATEX category → 54	536050	VL-5/3E-1/4-B-EX
		G3/8	–	14949	VL-5/3E-3/8-B
			ATEX category → 54	536051	VL-5/3E-3/8-B-EX
	Normally pressurised	G1/8	–	31310	VL-5/3B-1/8-B
			ATEX category → 54	536052	VL-5/3B-1/8-B-EX
		G1/4	–	14299	VL-5/3B-1/4-B
			ATEX category → 54	536053	VL-5/3B-1/4-B-EX
		G3/8	–	14951	VL-5/3B-3/8-B
			ATEX category → 54	536054	VL-5/3B-3/8-B-EX

Solenoid/pneumatic valves, Tiger 2000

Accessories



Manifold rail PAL...-B

Materials:
Anodised aluminium

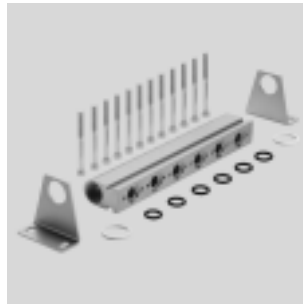

Dimensions

Download CAD data → www.festo.com

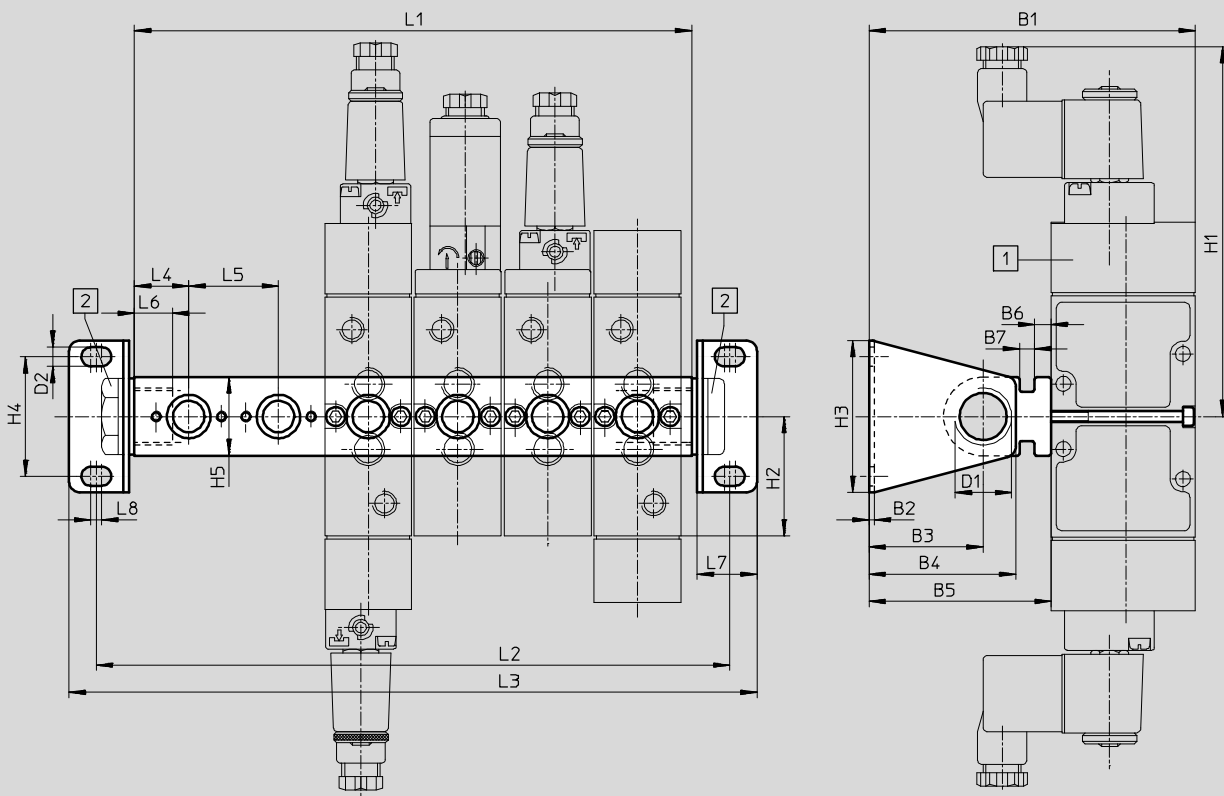

1 The end cap of all valves can be turned by 180°

2 Blanking plugs and reducing nipples are not included in the scope of delivery
→ Internet: Components for cable connections

Type	B1	B2	B3	B4	B5	B6	B7	D1	D2	H1	H2	H3	H4	L4	L5	L6	L7	L8
PAL-1/8-...	104	2	33.5	44.5	57	5	5.5	G3/8	5.2	130	38.5	44	32	18	27	12	20	4
PAL-1/4-...	120	2	42	54	67	6.1	5.5	G1/2	7	136	44	56	44	20	33	14	22	4
PAL-3/8-...	176	3	75	93	106	4	14	G3/4	9	147	50	80	60	25	41	17	30	5

Solenoid/pneumatic valves, Tiger 2000

FESTO

Accessories

Dimensions and ordering data						
Quantity	L1	L2	L3	Weight	Part No.	Type
Valve ports				[g]		
Pneumatic connection G1/8						
2	63	89	107	150	30552	PAL-1/8-2-B
3	90	116	134	190	30553	PAL-1/8-3-B
4	117	143	161	230	30554	PAL-1/8-4-B
5	144	170	188	260	30555	PAL-1/8-5-B
6	171	197	215	290	30556	PAL-1/8-6-B
7	198	224	242	340	30557	PAL-1/8-7-B
8	225	251	269	370	30558	PAL-1/8-8-B
9	252	278	296	410	30559	PAL-1/8-9-B
10	279	305	323	450	30560	PAL-1/8-10-B
Pneumatic connection G1/4						
2	73	101	121	230	30280	PAL-1/4-2-B
3	106	134	154	290	30281	PAL-1/4-3-B
4	139	167	187	350	30282	PAL-1/4-4-B
5	172	200	220	420	30283	PAL-1/4-5-B
6	205	233	253	480	30284	PAL-1/4-6-B
7	238	266	286	540	30285	PAL-1/4-7-B
8	271	299	319	600	30286	PAL-1/4-8-B
9	304	322	352	660	30 87	PAL-1/4-9-B
10	337	365	385	730	30288	PAL-1/4-10-B
Pneumatic connection G3/8						
2	91	127	155	510	30692	PAL-3/8-2-B
3	132	168	196	610	30693	PAL-3/8-3-B
4	173	209	237	720	30694	PAL-3/8-4-B
5	214	250	278	830	30695	PAL-3/8-5-B
6	255	291	319	960	30696	PAL-3/8-6-B
7	296	332	360	1060	30697	PAL-3/8-7-B
8	337	373	401	1160	30698	PAL-3/8-8-B
9	378	414	442	1260	30699	PAL-3/8-9-B
10	419	455	483	1360	30680	PAL-3/8-10-B

Solenoid/pneumatic valves, Tiger 2000

Accessories

Manifold block PRS

Materials:
Anodised aluminium

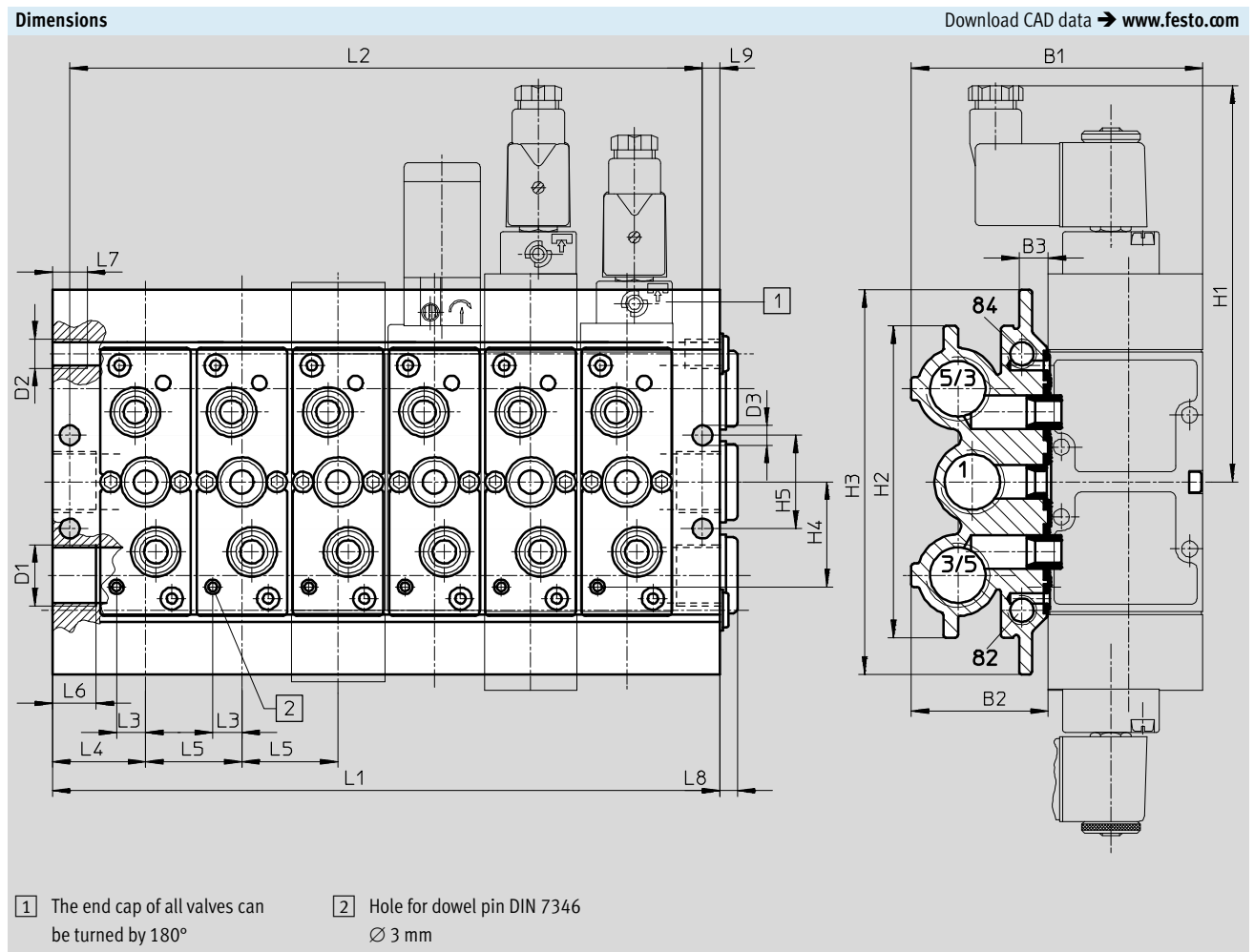
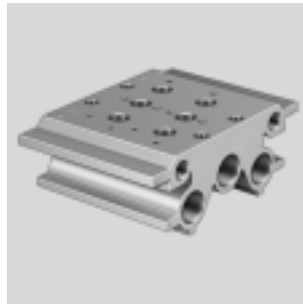

Type	B1	B2	B3	D1	D2	D3	H1	H2	H3	H4	H5	L3	L4	L5	L6	L7	L8	L9
PRS-1/8-...	93	45.5	11.2	G3/8	G1/8	6.8	130	95	120	27	27.5	9.4	25.5	27	14	8	5	6
PRS-1/4-...	100	47	10	G1/2	G1/8	6.8	136	107	132	36	32	10	32	33	15	12	6	9
PRS-3/8-...	131	60.5	12.5	G3/4	G1/8	9	147	128	153	44	44	15.2	36.5	41	16	12	6	7.5

Solenoid/pneumatic valves, Tiger 2000

Accessories

Dimensions and ordering data					
Quantity	L1	L2	Weight	Part No.	Type
Valve ports			[g]		
Pneumatic connection G1/8					
2	78	66	700	30542	PRS-1/8-2-BB
3	105	93	920	30543	PRS-1/8-3-BB
4	132	120	1150	30544	PRS-1/8-4-BB
5	159	147	1320	30545	PRS-1/8-5-BB
6	186	174	1520	30546	PRS-1/8-6-BB
7	213	201	1750	30547	PRS-1/8-7-BB
8	240	228	2010	30548	PRS-1/8-8-BB
9	267	255	2200	30549	PRS-1/8-9-BB
10	294	282	2400	30550	PRS-1/8-10-BB
Pneumatic connection G1/4					
2	97	85	1050	15861	PRS-1/4-2-B
3	130	118	1310	15862	PRS-1/4-3-B
4	163	151	1610	15863	PRS-1/4-4-B
5	196	184	1900	15864	PRS-1/4-5-B
6	229	217	2200	15865	PRS-1/4-6-B
7	262	250	2500	15866	PRS-1/4-7-B
8	295	283	2800	15867	PRS-1/4-8-B
9	328	316	3100	15868	PRS-1/4-9-B
10	361	349	3360	15869	PRS-1/4-10-B
Pneumatic connection G3/8					
2	114	99	1600	30682	PRS-3/8-2-B
3	155	140	2100	30683	PRS-3/8-3-B
4	196	181	2630	30684	PRS-3/8-4-B
5	237	222	3100	30685	PRS-3/8-5-B
6	278	263	3500	30686	PRS-3/8-6-B
8	360	345	4620	30688	PRS-3/8-8-B
10	442	427	5600	30690	PRS-3/8-10-B

Solenoid/pneumatic valves, Tiger 2000

Accessories

FESTO

Blanking plate for vacant positions PRSB

Materials:
Die-cast aluminium



Ordering data			
Pneumatic connection	Weight [g]	Part No.	Type
G1/8	33	15909	PRBS-1/8-B
G1/4	40	30666	PRSB-1/4-B
G3/8	72	30681	PRSB-3/8-B

Blanking plate for vacant positions PALB

Materials:
Steel



Ordering data			
Pneumatic connection	Weight [g]	Part No.	Type
G1/8	14	30903	PALB-1/8-B
G1/4	22	30904	PALB-1/4-B
G3/8	32	30905	PALB-3/8-B

Blanking plug PRSV for creating pressure zones

Materials:
Steel



Ordering data			
Pneumatic connection	Weight [g]	Part No.	Type
G1/8	18	160997	PRSV-1/8
G1/4	27	160996	PRSV-1/4

Solenoid/pneumatic valves, Tiger 2000

Accessories

Manual override AHB

Materials:

Polymer

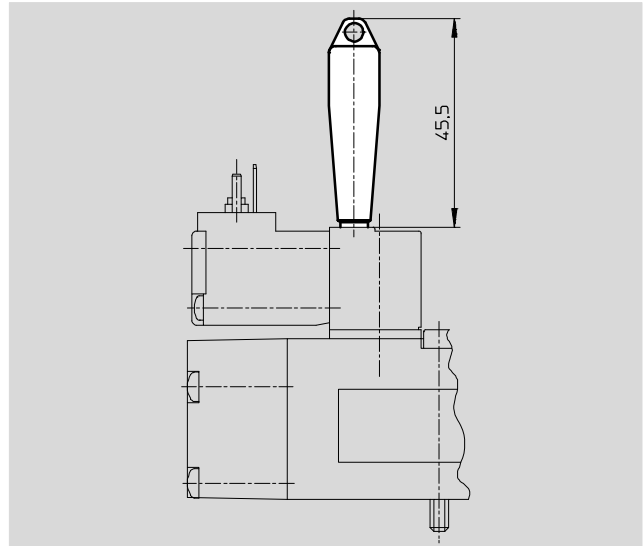

Ordering data				
For valve	Weight [g]	CRC ¹⁾	Part No.	Type
MFH/JMFH	10	2	157651	AHB-MD/MF/MV

1) Corrosion resistance class CRC 2 to Festo standard FN 940070
Moderate corrosion stress. Indoor applications in which condensation may occur. External visible parts with primarily decorative requirements for the surface and which are in direct contact with the ambient atmosphere typical for industrial applications.

Inscription label KMC/F/V-BZ-35X

Materials:

Polymer

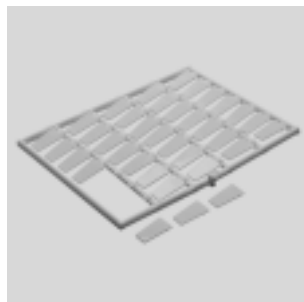

Ordering data			
	Weight [g]	Part No.	Type
Inscription label for valves (35 in frames included in the scope of delivery)	20	33362	KMC/F/V-BZ-35X



Ordering data – Solenoid coils			Technical data → Internet: msf	
	Voltage	Cable length [m]	Part No.	Type
F solenoid coils for valves MFH, JMFH				
	12 V DC	–	34410	MSFG-12DC-OD
	24 V DC and 42 V AC, 50 ... 60 Hz	–	34411	MSFG-24/42-50/60-OD
	42 V DC	–	34413	MSFG-42DC-OD
	24 V AC	–	34415	MSFG-24AC-OD
	48 V AC, 50 ... 60 Hz	–	34418	MSFW-48AC-OD
	110 V AC, 50 ... 60 Hz and 120 V AC, 60 Hz	–	34420	MSFW-110AC-OD
	230 V AC, 50 ... 60 Hz and 240 V AC, 60 Hz	–	34422	MSFW-230AC-OD
	240 V AC, 50 ... 60 Hz	–	34424	MSFW-240AC-OD

Solenoid/pneumatic valves, Tiger 2000

Accessories

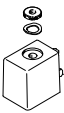
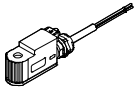
FESTO

Ordering data – Solenoid coils				Technical data → Internet: msf	
	Description	Voltage	Cable length [m]	Part No.	Type
F solenoid coils, without plug socket					
	–	12 V DC	–	34410	MSFG-12-OD
		24 V DC and 42 V AC, 50 ... 60 Hz	–	34411	MSFG-24/42-50/60-OD
		42 V DC	–	34413	MSFG-42-OD
		24 V AC	–	34415	MSFW-24-50/60-OD
		48 V AC, 50 ... 60 Hz	–	34418	MSFW-48-50/60-OD
		110 V AC, 50 ... 60 Hz and 120 V AC, 60 Hz	–	34420	MSFW-110-50/60-OD
		230 V AC, 50 ... 60 Hz and 240 V AC, 60 Hz	–	34422	MSFW-230-50/60-OD
		240 V AC, 50 ... 60 Hz	–	34424	MSFW-240-50/60-OD
	Explosion-proof	24 V DC	–	536931	MSFG-24-EX
		24 V AC	–	536932	MSFW-24-50/60-EX
		110 V AC	–	536933	MSFW-110-50/60-EX
		230 V AC	–	536934	MSFW-230-50/60-EX
F solenoid coils, cable with open end, 3-wire					
	Explosion-proof	24 V DC	1	8059804	VACF-B-K1-1-1-EX4-M
			5	8059805	VACF-B-K1-1-5-EX4-M
			10	8059806	VACF-B-K1-1-10-EX4-M
			20	8059807	VACF-B-K1-1-20-EX4-M
	24 V AC	1	8059808	VACF-B-K1-1A-1-EX4-M	
		5	8059812	VACF-B-K1-16B-5-EX4-M	
	110 V AC	1	8059811	VACF-B-K1-16B-1-EX4-M	
		5	8059812	VACF-B-K1-16B-5-EX4-M	
	230 V AC	1	8059809	VACF-B-K1-3A-1-EX4-M	
		5	8059810	VACF-B-K1-3A-5-EX4-M	

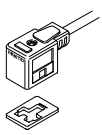
Ordering data – Plug sockets/connecting cables for F solenoid coils				Technical data → Internet: mssd	
	Description	Voltage	Cable length [m]	Part No.	Type
Plug socket without cable, cable connection with					
	Locking screws (cable connector Pg9)	–	–	34431	MSSD-F
	Locking screws (cable connector M16)	–	–	539710	MSSD-F-M16
	Insulation displacement technology (cable connector M16)	–	–	192746	MSSD-F-S-M16
Connecting cable					
Technical data → Internet: kmf					
	Signal status display with LED	24 V DC	2.5	30935	KMF-1-24DC-2,5-LED
			5	30937	KMF-1-24DC-5-LED
			10	193458	KMF-1-24DC-10-LED
	Without signal status display	Up to 240 V	2.5	30936	KMF-1-230AC-2,5
			5	30938	KMF-1-230AC-5

Solenoid/pneumatic valves, Tiger 2000

Accessories

Ordering data – Plug sockets/connecting cables for V solenoid coils					
	Description	Voltage	Cable length [m]	Part No.	Type
Plug socket without cable, cable connection with					Technical data → Internet: mssd
	Locking screws (cable connector Pg9)	–	–	33295	MSSD-V
	Locking screws (cable connector M16)	–	–	539713	MSSD-V-M16
Connecting cable					Technical data → Internet: kmv
	Signal status display with LED	24 V DC	2.5	30939	KMV-1-24DC-2,5-LED
			5	30941	KMV-1-24DC-5-LED
			10	193456	KMV-1-24-10-LED

Ordering data – Illuminating seals				Technical data → Internet: illuminated seal	
	Description	Voltage	Part No.	Type	
	For F solenoid coils	12 ... 24 V DC	19143	MF-LD-12-24DC	
		230 V DC/V AC	19144	MF-LD-230AC	
	For V solenoid coils	12 ... 24 V DC	35558	MV-LD-12-24DC	