

Pneumatic valves VUWS/valve manifold VTUS

FESTO



Pneumatic valves VUWS/valve manifold VTUS

Key features

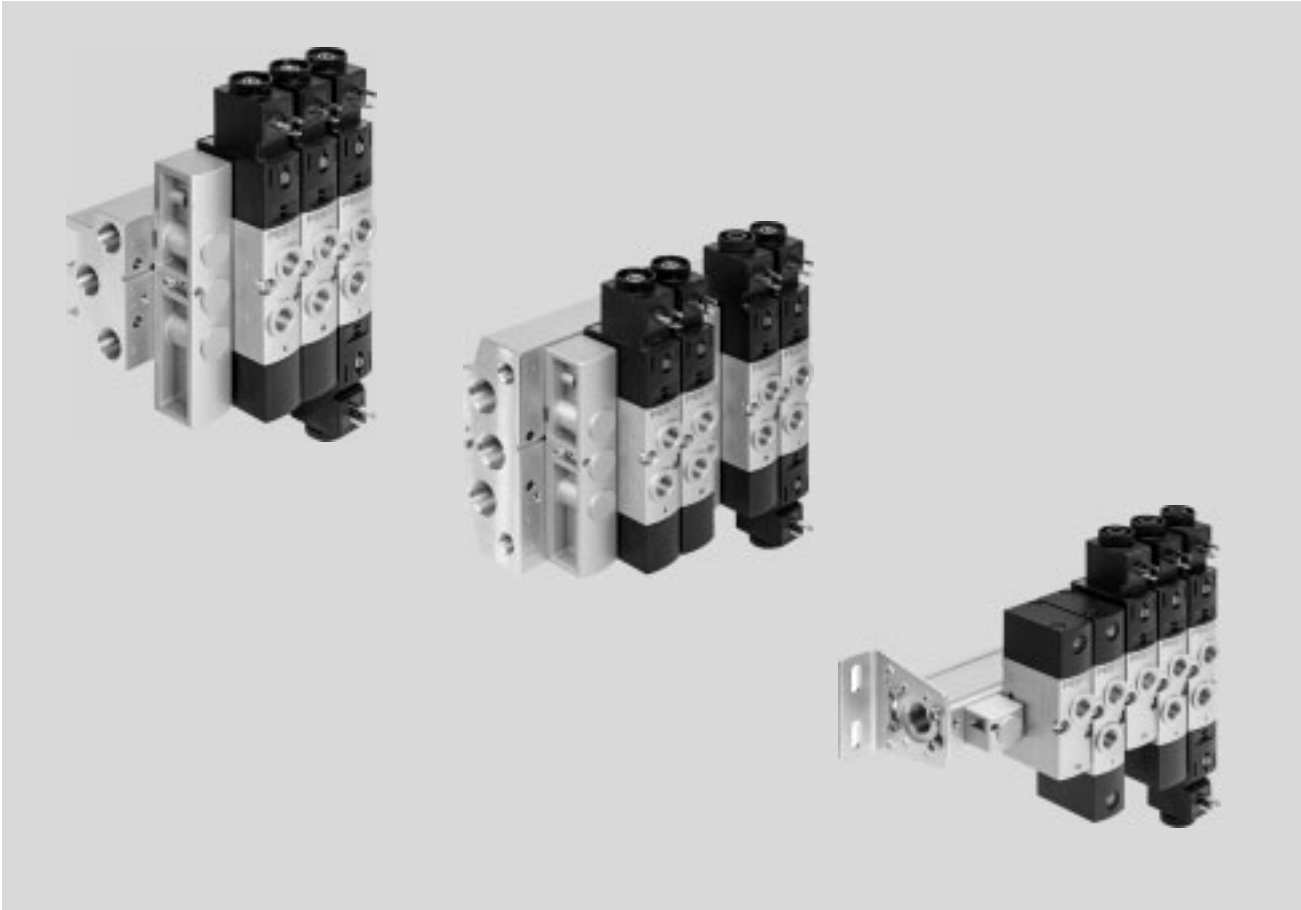

Innovative

- A reliable, heavy-duty valve with a long service life
- Design principle:
 - Disc seat soft-sealing (VUWS-LT)
 - Piston spool with sealing cartridge (VUWS-L)
- Flow rate up to 1800 l/min with VUWS-LT
- Flow rate up to 2300 l/min with VUWS-L
- Wide range of valve functions

Versatile

- In-line valves can be used as individual valves or manifold valves
- Variable pressure zones
- Wide range of mounting options

Reliable

- Ergonomic, reliable operation
- Durable thanks to tried and tested piston spools
- Reliable servicing thanks to valves that can be replaced quickly and easily

Easy to install

- Pre-assembled units on rails
- Individual valves assembled ready for installation
- Supply manifolds for mounting on one or both sides
- Secure mounting on wall or H-rail

Product configurator

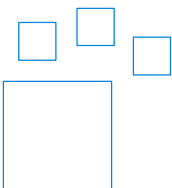

Configurable product
This product and all its options can be ordered using the configurator.

The configurator can be found under Products on the DVD or at
→ www.festo.com/catalogue/...

Part No.	Type
576517	VUWS-20
8022015	VUWS-25
8022018	VUWS-30
577304	VTUS-20
8022016	VTUS-25
8022019	VTUS-30

Pneumatic valves VUWS/valve manifold VTUS

Key features

Pneumatic valves VUWS

In-line valve VUWS-L as individual valve (piston spool valve)

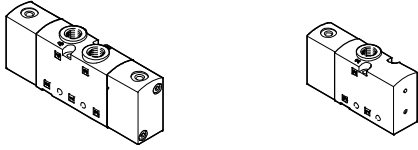

In-line valve VUWS-LT as individual valve (disc seat valve)

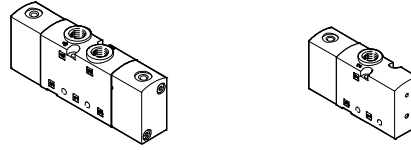

Valve manifold VTUS

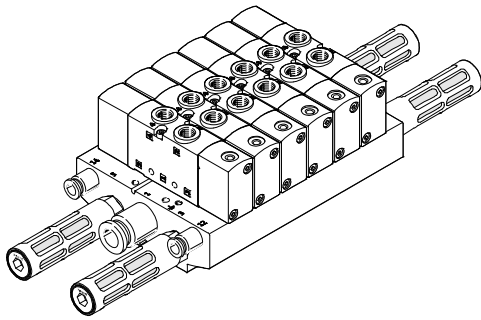

In-line valves are designed to be used without pneumatic linking. All pneumatic connections are on the valve and can be equipped with fittings/tubing.

By using a special seal set, the in-line valves can also be mounted on a manifold rail (pneumatic linking) as semi in-line valves.

Pneumatic valves VUWS have a sturdy design that enables them to be used in harsh environments.

Pneumatic valves VUWS are extremely well suited for controlling cylinders or compressed air networks for easy clamping and locking processes in semi-automatic assembly and manufacturing.

Equipment options

VUWS-LT

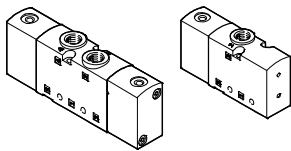

- 3/2-, 2x 3/2 and 5/2-way valves
- Size 20 (21 mm)
- Size 25 (26.5 mm)
- Size 30 (31 mm)
- In-line valves

Valve functions of VUWS-LT

3/2-way valve, normal position open, single solenoid:

- Reset via mechanical spring
- Direction of flow not reversible

3/2-way valve, normal position closed, single solenoid:

- Reset via mechanical spring
- Direction of flow not reversible

2x 3/2-way valve, normal position open, single solenoid:

- Reset via mechanical spring
- Direction of flow not reversible

2x 3/2-way valve, normal position closed, single solenoid:

- Reset via mechanical spring
- Direction of flow not reversible

2x 3/2-way valve, normal position 1x open, 1x closed, single solenoid:

- Internal/external pilot air supply
- Direction of flow not reversible

5/2-way single solenoid valve:

- Reset via mechanical spring
- Direction of flow not reversible
- Can also be used as 3/2-way valve by closing one outlet port

5/2-way double solenoid valve:

- Direction of flow not reversible

Pneumatic valves VUWS/valve manifold VTUS

Key features

Equipment options

VUWS-L

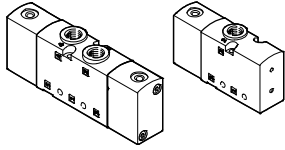

- Size 20 (21 mm)
- Size 25 (26.5 mm)
- Size 30 (31 mm)
- 3/2-, 5/2- and 5/3-way valves
- In-line valves

Valve functions of VUWS-L

- 3/2-way valve, normal position open, monostable:
- External pneumatic spring connection (M32U-E)
 - Reset via pneumatic/mechanical spring
 - Direction of flow reversible with return via mechanical spring or external pneumatic spring connection
 - Dual-pressure operation possible
 - If the external pneumatic spring connection is used as signal input, the result is a dominant bistable valve

- 5/2-way valve, monostable:
- External pneumatic spring connection (M52-E)
 - Reset via pneumatic/mechanical spring
 - Direction of flow reversible with return via mechanical spring or external pneumatic spring connection
 - Can also be used as 3/2-way valve by closing one outlet port

- 5/2-way valve, bistable:
- Direction of flow reversible

- 3/2-way valve, normal position closed, monostable:
- External pneumatic spring connection (M32C-E)
 - Reset via pneumatic/mechanical spring
 - Direction of flow reversible with return via mechanical spring or external pneumatic spring connection
 - Dual-pressure operation possible
 - If the external pneumatic spring connection is used as signal input, the result is a dominant bistable valve

- 5/3-way valve, mid-position exhausted, pressurised or closed:
- Direction of flow reversible
 - Reset via mechanical spring

Key features

- A maximum of 16 valve positions can be configured in the standard version
- A maximum of 12 valve positions can be configured in the compact version
- Valve positions 2 ... 10 can be configured in increments of 1, valve positions 10 ... 16 in increments of 2
- Manifold block with a maximum of 10 valve positions
- Extension module with 2 valve positions
- Supply manifold with a maximum of 10 valve positions
- Creation of pressure zones (maximum 9 pressure zones in the case of a valve manifold with 16 valve positions)

Design

Valve replacement

Each valve is attached to the manifold block using two screws. The appropriate seal is mounted on the valve.

This means that the valves can be easily replaced.

Extension

Valve positions covered with blanking plates can be replaced with valves at a later date. The dimensions, mounting points and existing pneumatic installations

remain unchanged. For the standard manifold block, extension modules with 2 valve positions are available.

Pneumatic valves VUWS/valve manifold VTUS

Key features

Standard manifold block

For 3/2-way valves

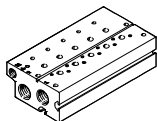

- Connection:
Size 20: G3/8
Size 25: G1/2
Size 30: G3/4
- Maximum 10 valve positions

For 5/2- and 5/3-way valves

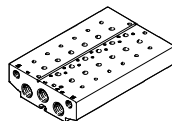

- Connection:
Size 20: G3/8
Size 25: G1/2
Size 30: G3/4
- Maximum 10 valve positions

Extension for standard manifold block

For 3/2-way valves

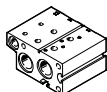

- Connection:
Size 20: G3/8
Size 25: G1/2
Size 30: G3/4
- Maximum two valve positions

For 5/2- and 5/3-way valves

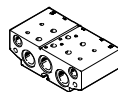

- Connection:
Size 20: G3/8
Size 25: G1/2
Size 30: G3/4
- Maximum two valve positions

Compact manifold block

For 3/2-way valves

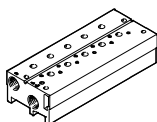

- Connection:
Size 20: G1/4
Size 25: G3/8
Size 30: G1/2
- Maximum 10 valve positions

For 5/2- and 5/3-way valves

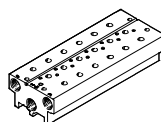

- Connection:
Size 20: G1/4
Size 25: G3/8
Size 30: G1/2
- Maximum 10 valve positions

Supply manifold

Mounting on both sides

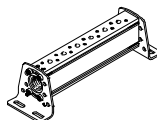

- Connection:
Size 20: G3/8
Size 25: G1/2
Size 30: G3/4
- Maximum 10 valve positions

Mounting on one side

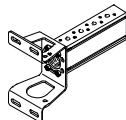

- Connection:
Size 20: G3/8
Size 25: G1/2
Size 30: G3/4
- Maximum 4 valve positions

Blanking plate for unused valve position

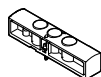

For covering unused valve positions

Supply plate

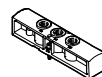

For additional air supply and exhaust via a valve position

Separator for pressure zones



For creating pressure zones (maximum 9 pressure zones permitted)

Note

A filter must be installed upstream of the intake air getting into the valve (e.g. when operating a suction cup). This prevents any foreign matter in

Pneumatic valves VUWS/valve manifold VTUS

Key features – Pneumatics

Creating pressure zones and separating exhaust air

Compressed air is supplied and exhausted via the manifold block/ supply manifold and via supply plates.

The position of the supply plates and duct separations can be freely selected with the VTUS.

A pressure zone is created by isolating the internal ducts between the valve positions by means of an appropriate separator.

The separator can be used in the following ducts:

- Duct 1
- Duct 3
- Duct 5

 Note

- Use a separator if the exhaust air pressures are high
- Use at least one supply plate/ supply for each pressure zone

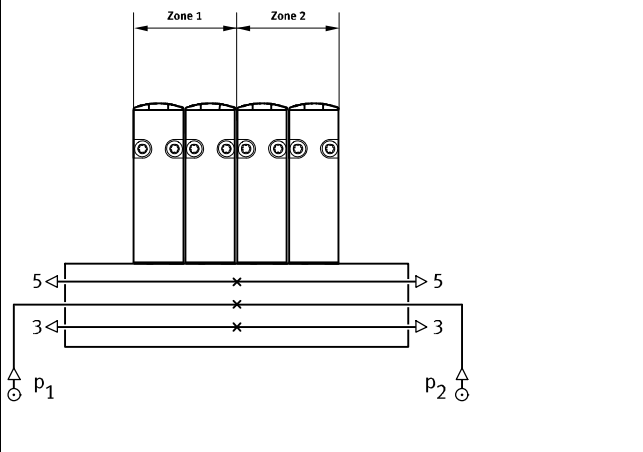
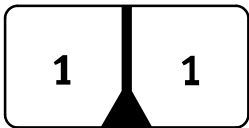
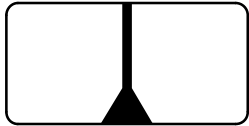
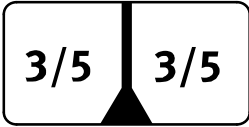
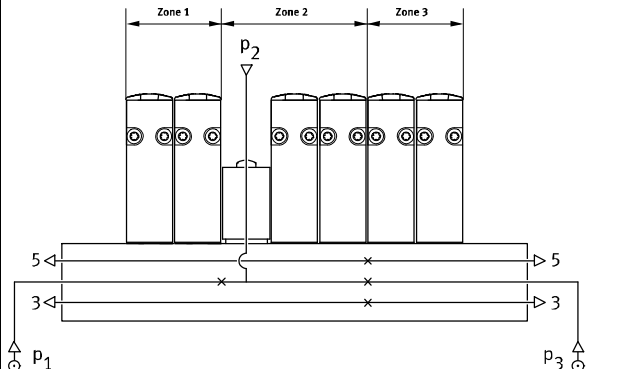
Duct separation	Description
	<p>The pressure zones can be freely configured with the VTUS. The following duct separations are possible:</p> <ul style="list-style-type: none"> • Duct 1 closed  • Duct 1/3/5 closed  • Duct 3/5 closed 
	<p>The number of pressure zones with the VTUS is limited by the number of valve positions on the manifold block/supply manifold. Note that each supply plate occupies one valve position. There must always be at least 2 valve positions between 2 separators. In the case of a maximum extension of 16 valve positions, a maximum of 9 pressure zones can be created.</p>

Pneumatic valves VUWS/valve manifold VTUS

Key features – Pneumatics VUWS-LT

Size 20 – Standard nominal flow rate q_{nN} , with several valves n switched in parallel

For 3/2-way valves

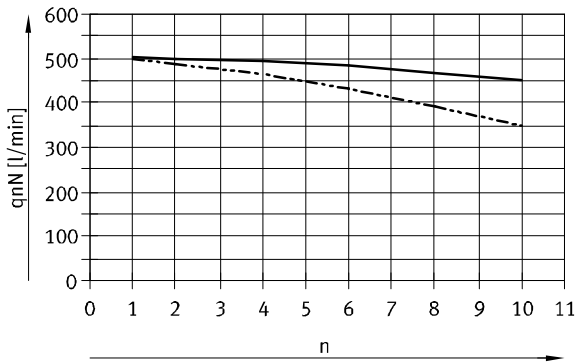

— Standard nominal flow rate per valve on manifold rail standard
- - - Standard nominal flow rate per valve on manifold rail compact

For 5/2-way valves, flow direction 1 → 2

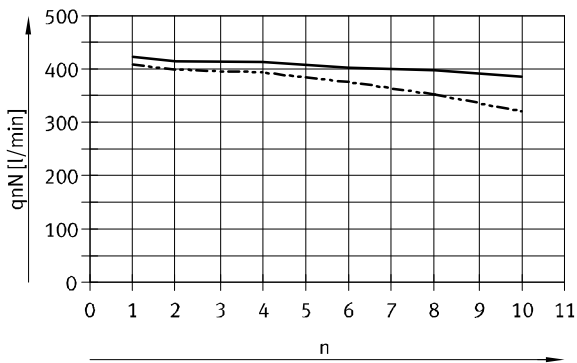

— Standard nominal flow rate per valve on manifold rail standard
- - - Standard nominal flow rate per valve on manifold rail compact

For 5/2-way valves, flow direction 1 → 4

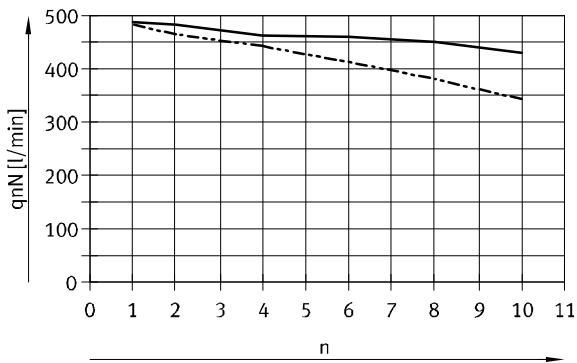

— Standard nominal flow rate per valve on manifold rail standard
- - - Standard nominal flow rate per valve on manifold rail compact

Pneumatic valves VUWS/valve manifold VTUS

Key features – Pneumatics VUWS-LT

Size 20 – Standard nominal flow rate q_{nN} , with several valves n switched in parallel

For 2x 3/2-way valves

One valve function per valve position in open switching position

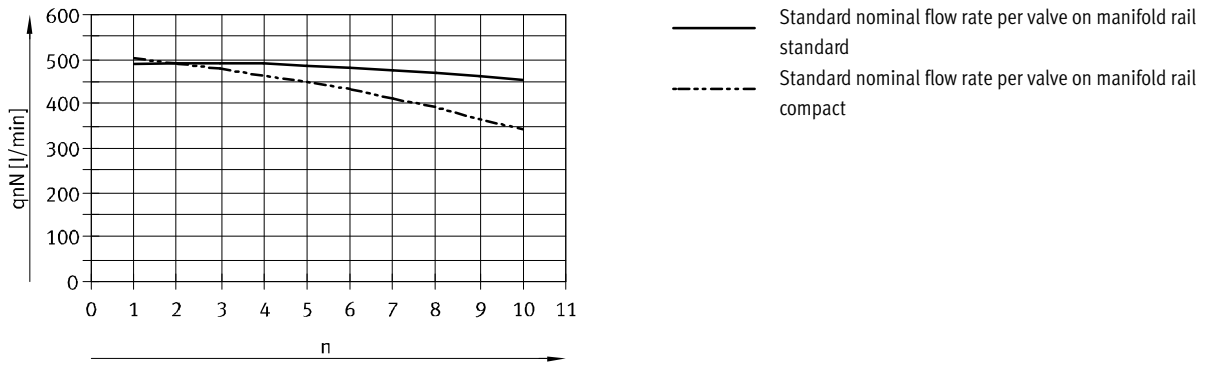

For 2x 3/2-way valves

Both valve functions per valve position simultaneously in open switching position

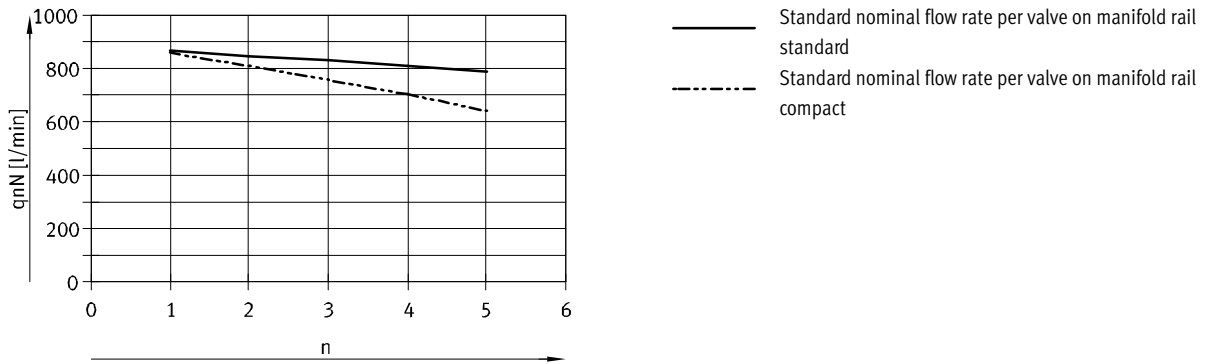

Pneumatic valves VUWS/valve manifold VTUS

Key features – Pneumatics VUWS-LT

Size 25 – Standard nominal flow rate q_{nN} , with several valves n switched in parallel

For 3/2-way valves

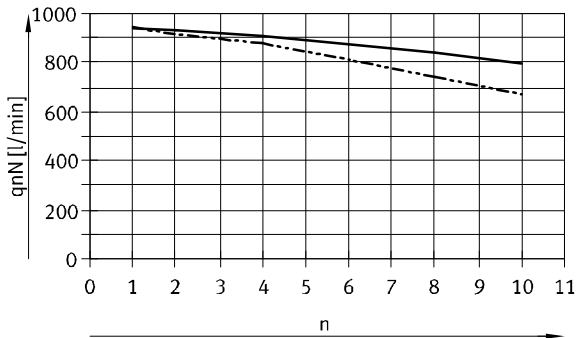

- Standard nominal flow rate per valve on manifold rail standard
- - - Standard nominal flow rate per valve on manifold rail compact

For 5/2-way valves, flow direction 1 → 2

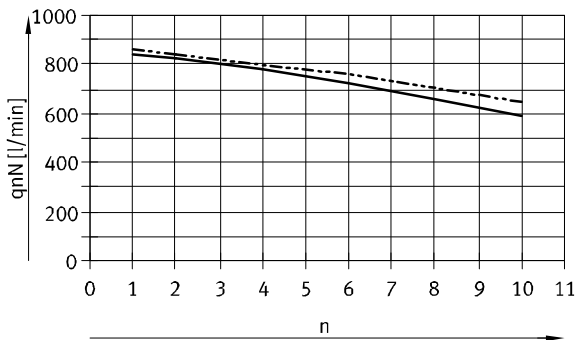

- Standard nominal flow rate per valve on manifold rail standard
- - - Standard nominal flow rate per valve on manifold rail compact

For 5/2-way valves, flow direction 1 → 4

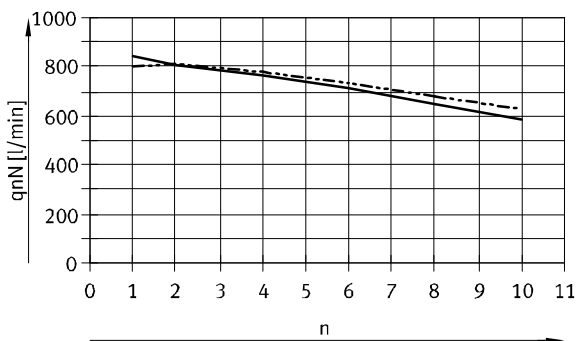

- Standard nominal flow rate per valve on manifold rail standard
- - - Standard nominal flow rate per valve on manifold rail compact

Pneumatic valves VUWS/valve manifold VTUS

Key features – Pneumatics VUWS-LT

Size 25 – Standard nominal flow rate q_{nN} , with several valves n switched in parallel

For 2x 3/2-way valves

One valve function per valve position in open switching position

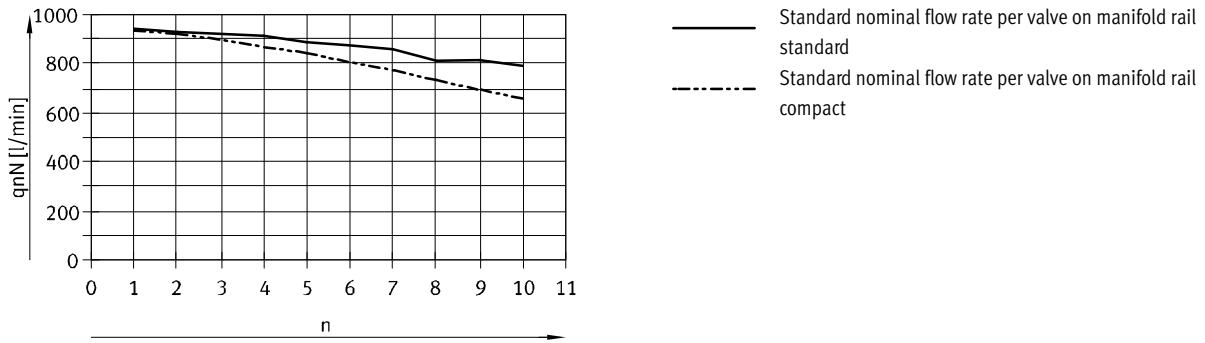

For 2x 3/2-way valves

Both valve functions per valve position simultaneously in open switching position

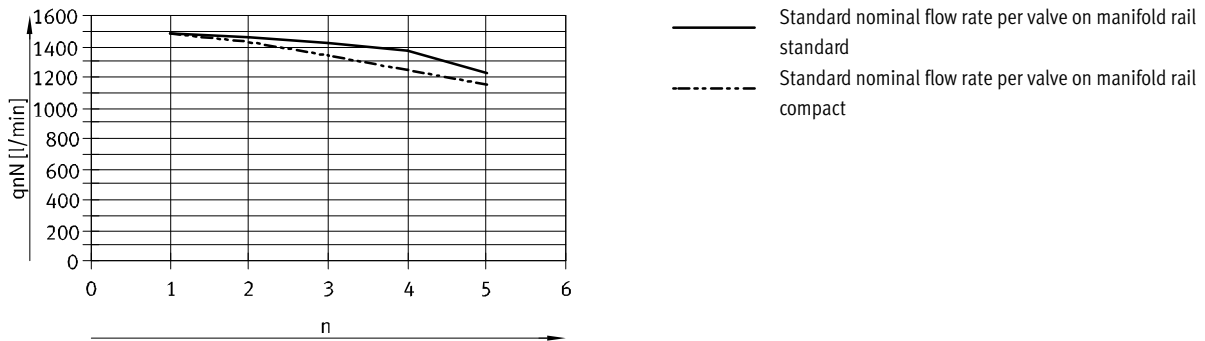

Pneumatic valves VUWS/valve manifold VTUS

Key features – Pneumatics VUWS-LT

Size 30 – Standard nominal flow rate q_{nN} , with several valves n switched in parallel

For 3/2-way valves

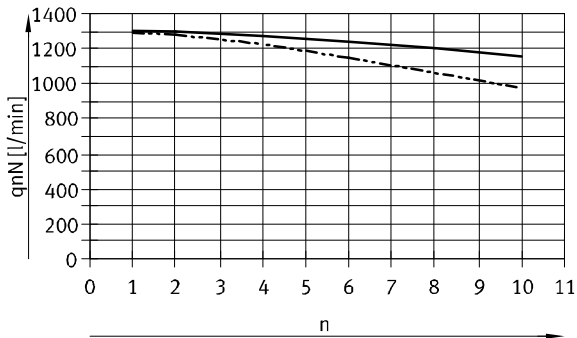

- Standard nominal flow rate per valve on manifold rail standard
- - - Standard nominal flow rate per valve on manifold rail compact

For 5/2-way valves, flow direction 1 → 2

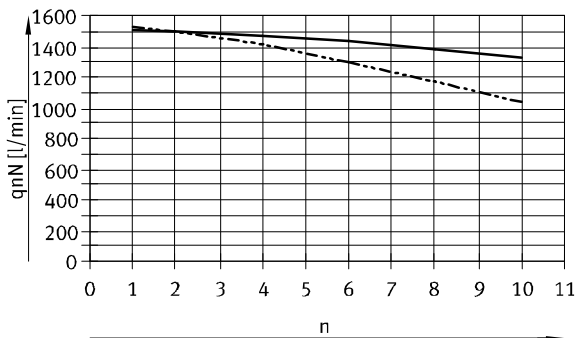

- Standard nominal flow rate per valve on manifold rail standard
- - - Standard nominal flow rate per valve on manifold rail compact

For 5/2-way valves, flow direction 1 → 4

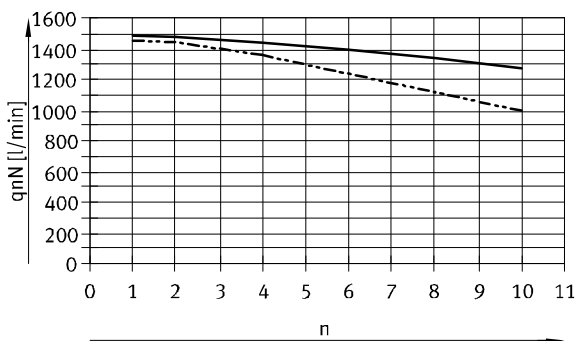

- Standard nominal flow rate per valve on manifold rail standard
- - - Standard nominal flow rate per valve on manifold rail compact

Pneumatic valves VUWS/valve manifold VTUS

Key features – Pneumatics VUWS-LT

Size 30 – Standard nominal flow rate q_{nN} , with several valves n switched in parallel

For 2x 3/2-way valves

One valve function per valve position in open switching position

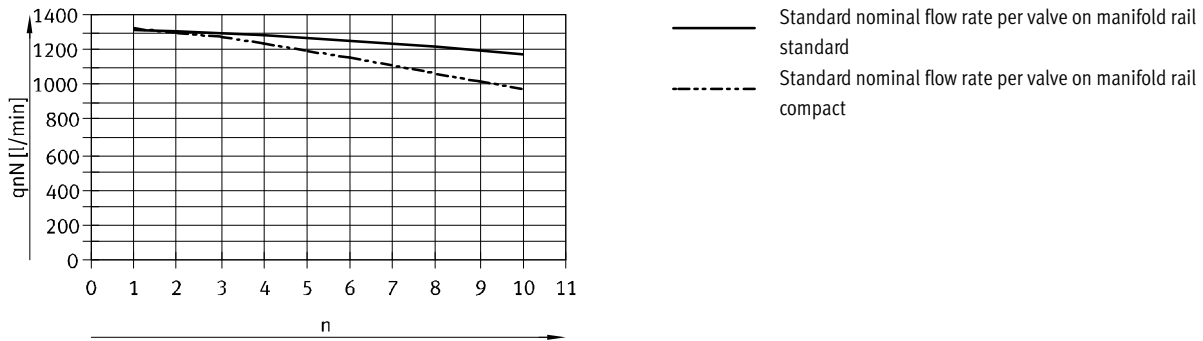

For 2x 3/2-way valves

Both valve functions per valve position simultaneously in open switching position

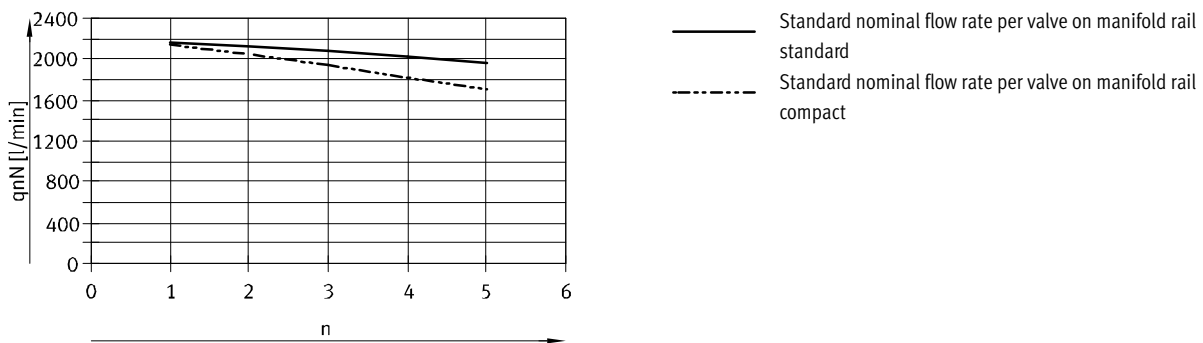

Pneumatic valves VUWS/valve manifold VTUS

Key features – Pneumatics VUWS-L

Size 20 – Standard nominal flow rate q_{nN} , with several valves n switched in parallel

For 3/2-way valves

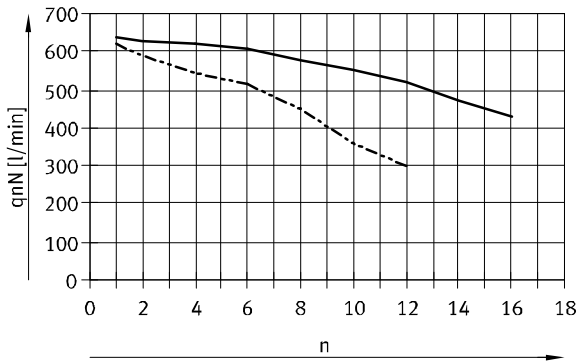

—— Standard nominal flow rate per valve on manifold rail standard
 - - - - Standard nominal flow rate per valve on manifold rail compact

For 5/2- and 5/3-way valves

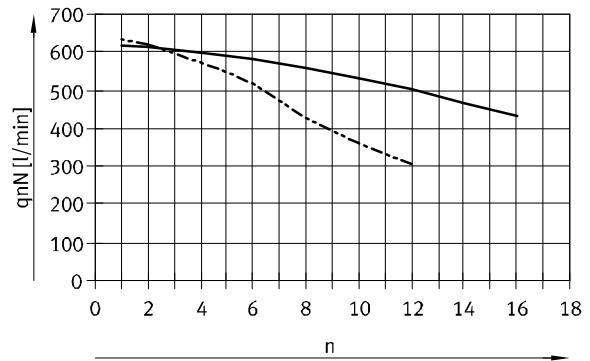

—— Standard nominal flow rate per valve on manifold rail standard
 - - - - Standard nominal flow rate per valve on manifold rail compact

Size 25 – Standard nominal flow rate q_{nN} , with several valves n switched in parallel

For 3/2-way valves

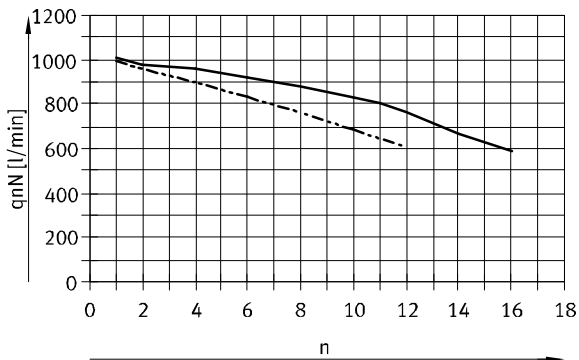

—— Standard nominal flow rate per valve on manifold rail standard
 - - - - Standard nominal flow rate per valve on manifold rail compact

For 5/2- and 5/3-way valves

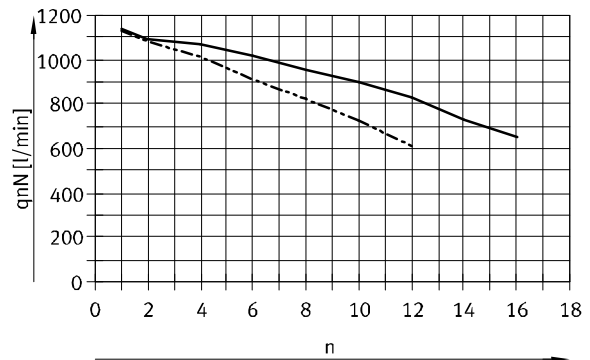

—— Standard nominal flow rate per valve on manifold rail standard
 - - - - Standard nominal flow rate per valve on manifold rail compact

Pneumatic valves VUWS/valve manifold VTUS

Key features – Pneumatics VUWS-L

Size 30 – Standard nominal flow rate q_{nN} , with several valves n switched in parallel

For 3/2-way valves

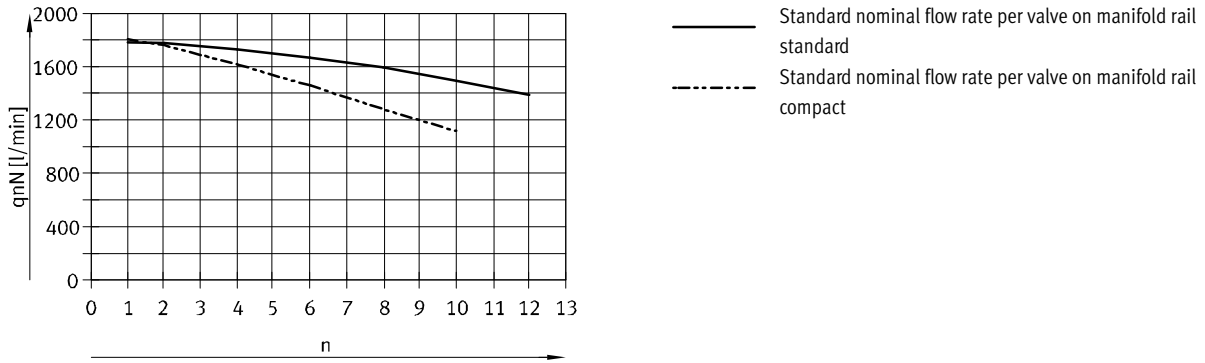

For 5/2- and 5/3-way valves

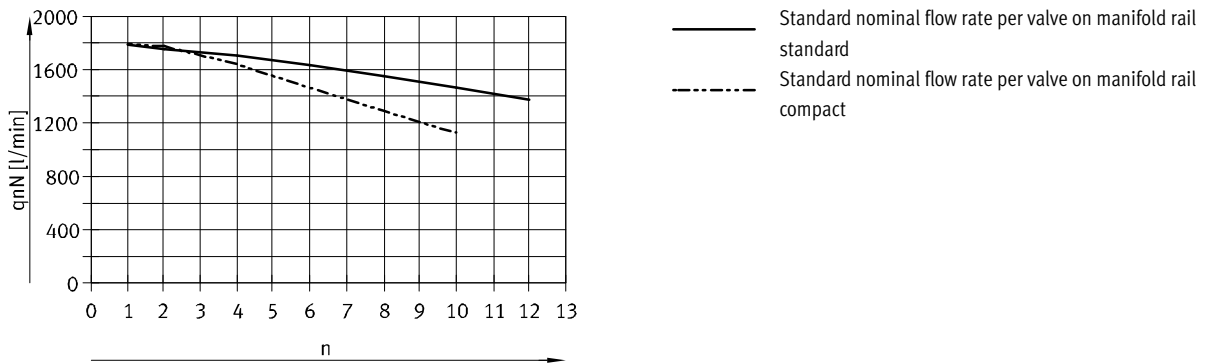

Pneumatic valves VUWS/valve manifold VTUS

Key features – Pneumatics VUWS-LT

Size 20 – Pilot pressure p_2 as a function of working pressure p_1

For 3/2-way valves

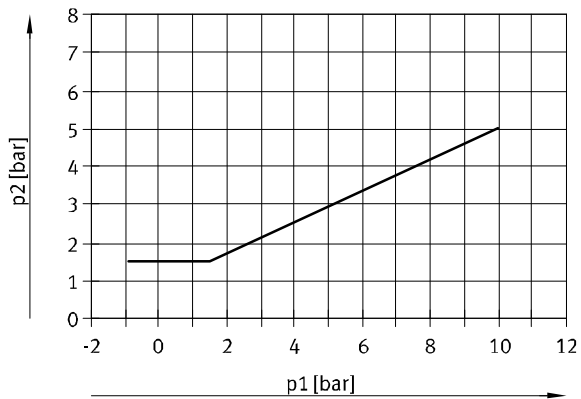

Size 25 – Pilot pressure p_2 as a function of working pressure p_1

For 3/2-way valves

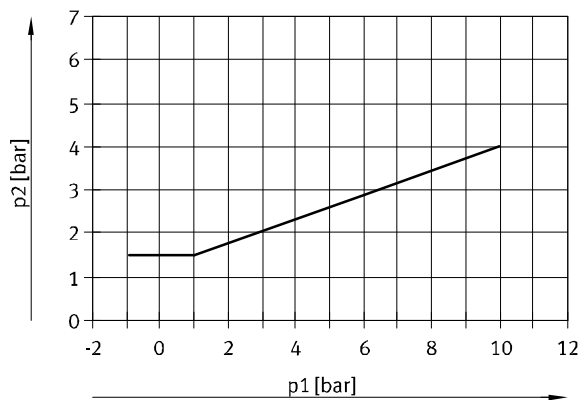

Pneumatic valves VUWS/valve manifold VTUS

Key features – Pneumatics VUWS-LT

Size 30 – Pilot pressure p2 as a function of working pressure p1

For 3/2-way valves

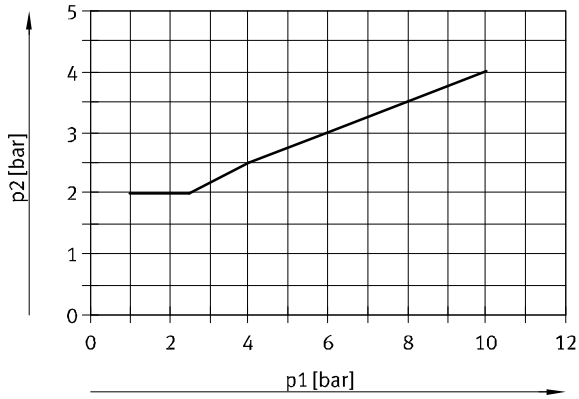

For 3/2-way valves, single solenoid

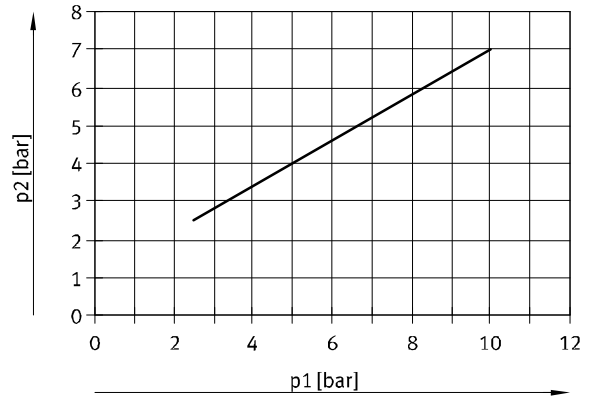

For 3/2-way valves, double solenoid

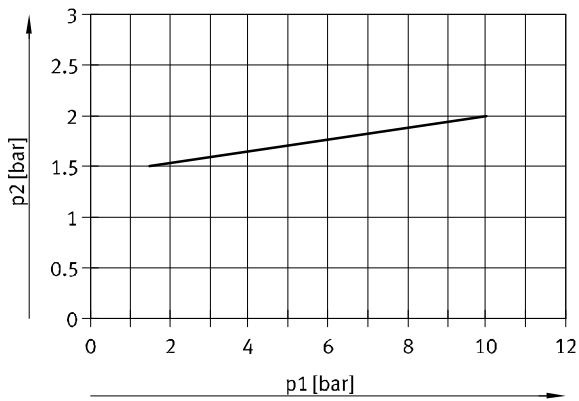

Pneumatic valves VUWS/valve manifold VTUS

Key features – Assembly

Mounting the valve manifold

Sturdy valve manifold owing to:

- Four through-holes for wall mounting
- H-rail mounting



Note

Use the thread M4 (M5 for size 30) provided on the manifold block for earthing the valve manifold.

Wall mounting

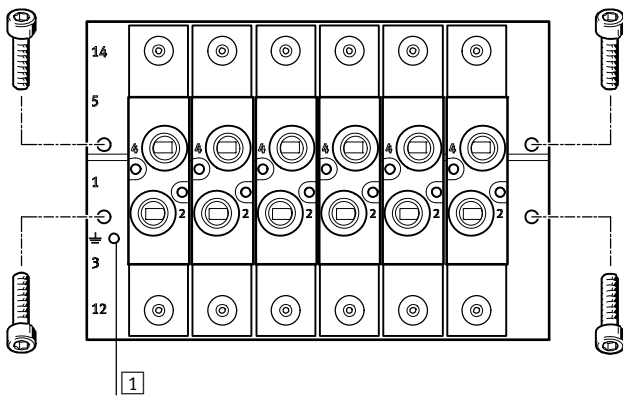

Sturdy wall mounting of the manifold block using four through-holes.

1 Earth terminal

H-rail mounting

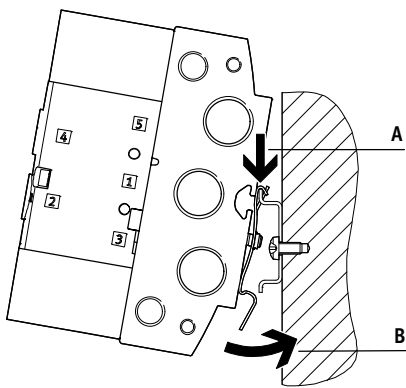

The H-rail mounting VAME-T-M... consists of two mounting clips. These are screwed to the manifold block on the left and right.

The prepared manifold block is then lowered onto the H-rail from above (arrow A) and clipped into the H-rail at the bottom (arrow B).



Note

- Note the max. tightening torque of the screws for H-rail mounting.
- Only horizontal H-rail mounting is permissible.
- Mounting only possible on H-rail TH 35-... to EN 60715.
- Vibration/shock loads are not permissible with H-rail mounting.
- Further note on assembly
→ Assembly instructions for H-rail mounting VAME-T-M...

Pneumatic valves VUWS/valve manifold VTUS

Key features – Assembly

Mounting individual valve VUWS

Wall mounting

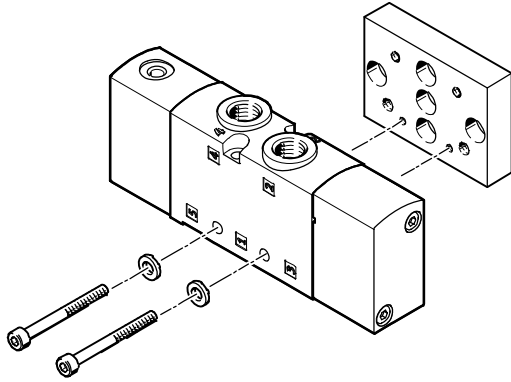

For mounting individual valves on a flat surface, e.g. aluminium profile systems. The pneumatic valves are provided with two through-holes for attaching to the wall mounting VAME-B10-20-W.

The screw set required is included with the wall mounting VAME-B10-20-W. The wall mounting VAME-B10-20-W can be used for sizes 20, 25 and 30.

Foot mounting

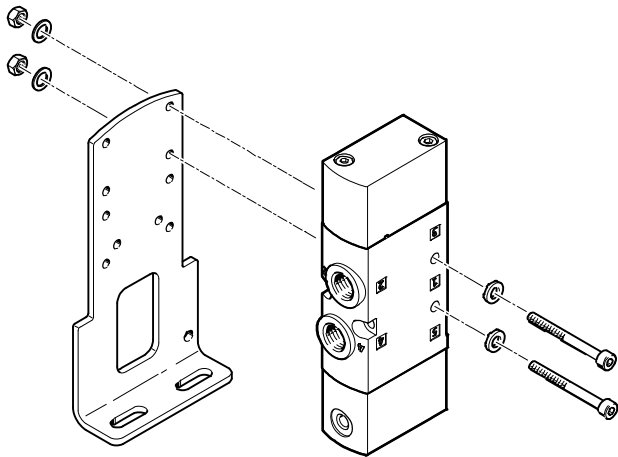

For mounting individual valves on a flat surface, e.g. aluminium profile systems. The pneumatic valves are provided with two through-holes for attaching to the foot mounting VAME-B10-...-A.

The screw set required is included with the foot mounting VAME-B10-...-A.

-  - Note

Further mounting options for foot mounting VAME-B10-...-A

➔ Technical data – Pneumatic valves, dimensions

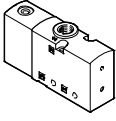
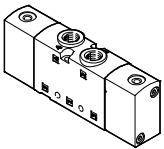
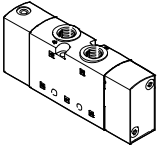
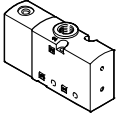
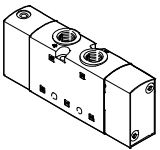
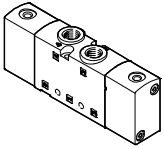

Pneumatic valves VUWS/valve manifold VTUS

Product range overview

Design	Size	Working port	Order code for valves and flow rate [l/min]										→ Page/ Internet
			M32C	M32U	T32C	T32U	T32H	M52	B52	P53C	P53E	P53U	
3/2-way valve VUWS-LT													
	20	G1/8	600	600	-	-	-	-	-	-	-	-	44
	25	G1/4	1000	1000	-	-	-	-	-	-	-	-	61
	30	G3/8	1600	1600	-	-	-	-	-	-	-	-	64
2x 3/2-way valve VUWS-LT													
	20	G1/8	-	-	600	600	600	-	-	-	-	-	44
	25	G1/4	-	-	1000	1000	1000	-	-	-	-	-	61
	30	G3/8	-	-	1600	1600	1600	-	-	-	-	-	64
5/2-way valve VUWS-LT													
	20	G1/8	-	-	-	-	-	500	500	-	-	-	44
	25	G1/4	-	-	-	-	-	1000	1000	-	-	-	61
	30	G3/8	-	-	-	-	-	1800	1800	-	-	-	64
3/2-way valve VUWS-L													
	20	G1/8	700	700	-	-	-	-	-	-	-	-	82
	25	G1/4	1000	1000	-	-	-	-	-	-	-	-	92
	30	G3/8	2300	2300	-	-	-	-	-	-	-	-	102
5/2-way valve VUWS-L													
	20	G1/8	-	-	-	-	-	700	700	-	-	-	82
	25	G1/4	-	-	-	-	-	1300	1300	-	-	-	92
	30	G3/8	-	-	-	-	-	2300	2300	-	-	-	102
5/3-way valve VUWS-L													
	20	G1/8	-	-	-	-	-	-	-	700	600	600	82
	25	G1/4	-	-	-	-	-	-	-	1200	1000	1000	92
	30	G3/8	-	-	-	-	-	-	-	2000	1600	1600	102

Pneumatic valves VUWS/valve manifold VTUS

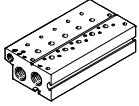
Product range overview

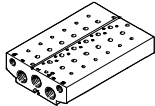
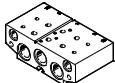
Design	Size	Description	→ Page/ Internet	
Manifold block for 3/2-way valves, standard				
	20	VABM-B10-20E-G38- ... -P3	Connection G3/8	113
	25	VABM-B10-25E-G12- ... -P3	Connection G1/2	126
	30	VABM-B10-30E-G34- ... -P3	Connection G3/4	139
Manifold block extension module for 3/2-way valves, standard				
	20	VABM-B10-20EEE-G38- ... -P3	Connection G3/8	113
	25	VABM-B10-25EEE-G12- ... -P3	Connection G1/2	126
	30	VABM-B10-30EEE-G34- ... -P3	Connection G3/4	139
Manifold block for 5/2- and 5/3-way valves, standard				
	20	VABM-B10-20E-G38- ...	Connection G3/8	113
	25	VABM-B10-25E-G12- ...	Connection G1/2	126
	30	VABM-B10-30E-G34- ...	Connection G3/4	139
Manifold block extension module for 5/2- and 5/3-way valves, standard				
	20	VABM-B10-20EEE-G38- ...	Connection G3/8	113
	25	VABM-B10-25EEE-G12- ...	Connection G1/2	126
	30	VABM-B10-30EEE-G34- ...	Connection G3/4	139

Pneumatic valves VUWS/valve manifold VTUS

Product range overview

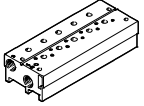
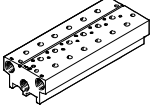
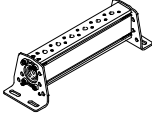
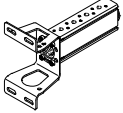
Design	Size	Description	→ Page/ Internet	
Manifold block for 3/2-way valves, compact				
	20	VABM-B10-20S-G14- ...-P3	Connection G1/4	113
	25	VABM-B10-25S-G38- ...-P3	Connection G3/8	126
	30	VABM-B10-30S-G12- ...-P3	Connection G1/2	139
Manifold block for 5/2- and 5/3-way valves, compact				
	20	VABM-B10-20S-G14- ...	Connection G1/4	113
	25	VABM-B10-25S-G38- ...	Connection G3/8	126
	30	VABM-B10-30S-G12- ...	Connection G1/2	139
Supply manifold, for mounting on both sides				
	20	VABM-B10-20-G38- ... -P53	Connection G3/8	114
	25	VABM-B10-25-G12- ... -P53	Connection G1/2	127
	30	VABM-B10-30-G34- ... -P53	Connection G3/4	140
Supply manifold, for mounting on one side				
	20	VABM-B10-20-G38- ... -P53-E	Connection G3/8	114
	25	VABM-B10-25-G12- ... -P53-E	Connection G1/2	127
	30	VABM-B10-30-G34- ... -P53-E	Connection G3/4	140

Pneumatic valves VUWS

Valve function

Valve	Order code for valves	Description	VUWS-LT			VUWS-L		
			Size			Size		
			20	25	30	20	25	30
3/2-way valve, normally closed, pneumatic spring								
	M32C-A	<ul style="list-style-type: none"> Internal pneumatic spring supply Direction of flow: not reversible 	-	-	-	■	■	■
	M32C-E	<ul style="list-style-type: none"> External pneumatic spring supply Direction of flow: reversible 	-	-	-	■	■	■
3/2-way valve, normally closed, pneumatic/mechanical spring								
	M32C-M	<ul style="list-style-type: none"> Direction of flow: reversible Reset: mechanical spring, supported internally by pneumatic spring 	-	-	-	■	-	-
3/2-way valve, normally closed, mechanical spring								
	M32C-M	Direction of flow: not reversible	■	■	■	-	-	-
	M32C-M	Direction of flow: reversible	-	-	-	-	■	■
3/2-way valve, normally open, pneumatic spring								
	M32U-A	<ul style="list-style-type: none"> Internal pneumatic spring supply Direction of flow: not reversible Reset: pneumatic spring 	-	-	-	■	■	■
	M32U-E	<ul style="list-style-type: none"> External pneumatic spring supply Direction of flow: reversible Reset: pneumatic spring 	-	-	-	■	■	■
3/2-way valve, normally open, pneumatic/mechanical spring								
	M32U-M	<ul style="list-style-type: none"> Direction of flow: reversible Reset: mechanical spring, supported internally by pneumatic spring 	-	-	-	■	-	-
3/2-way valve, normally open, mechanical spring								
	M32U-M	Direction of flow: not reversible	■	■	■	-	-	-
	M32U-M	Direction of flow: reversible	-	-	-	-	■	■

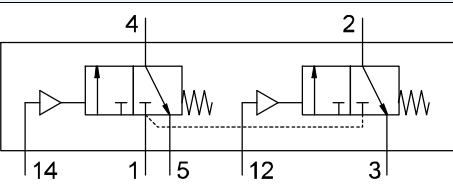
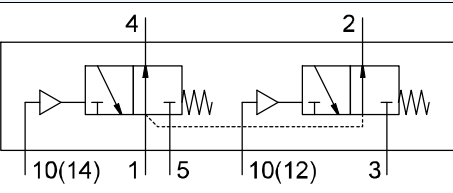
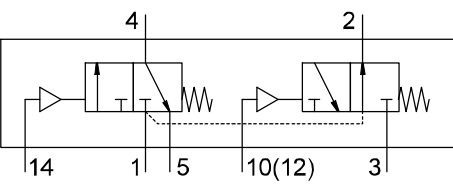

Pneumatic valves VUWS

Valve function

Valve	Order code for valves	Description	VUWS-LT			VUWS-L		
			Size			Size		
			20	25	30	20	25	30
2x 3/2-way valve, normally closed, mechanical spring								
	T32C	<ul style="list-style-type: none"> Internal pilot air supply Direction of flow: not reversible 	■	■	■	-	-	-
2x 3/2-way valve, normally open, mechanical spring								
	T32U	<ul style="list-style-type: none"> Internal pilot air supply Direction of flow: not reversible 	■	■	■	-	-	-
2x 3/2-way valve, 1x normally open, 1x normally closed, mechanical spring								
	T32H	<ul style="list-style-type: none"> Internal pilot air supply Direction of flow: not reversible 	■	■	■	-	-	-

Pneumatic valves VUWS

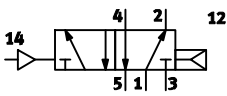
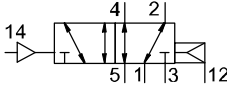
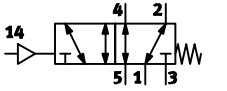
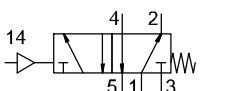
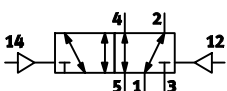
Valve function

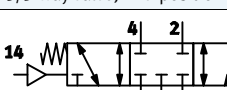
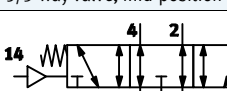
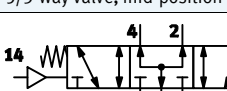
Valve	Order code for valves	Description	VUWS-LT			VUWS-L		
			Size			Size		
			20	25	30	20	25	30
5/2-way valve, pneumatic spring, monostable								
	M52-A	<ul style="list-style-type: none"> Internal pneumatic spring supply Direction of flow: not reversible 	-	-	-	■	■	■
	M52-E	<ul style="list-style-type: none"> External pneumatic spring supply Direction of flow: reversible 	-	-	-	■	■	■
5/2-way valve, mechanical spring, monostable								
	M52-M	Direction of flow: reversible	-	-	-	■	■	■
	M52-M	<ul style="list-style-type: none"> Direction of flow: not reversible Reset: mechanical spring, supported internally by pneumatic spring 	■	■	■	-	-	-
5/2-way valve, bistable								
	B52	Direction of flow: reversible	-	-	-	■	■	■
	B52	<ul style="list-style-type: none"> Direction of flow: not reversible Holding the switching position: via latch 	■	■	■	-	-	-
5/3-way valve, mid-position closed								
	P53C	Direction of flow: reversible	-	-	-	■	■	■
5/3-way valve, mid-position exhausted								
	P53E	Direction of flow: reversible	-	-	-	■	■	■
5/3-way valve, mid-position pressurised								
	P53U	Direction of flow: reversible	-	-	-	■	■	■

Pneumatic valves VUWS/valve manifold VTUS

Peripherals overview VUWS-LT, VUWS-L

Manifold block for 3/2-way valves

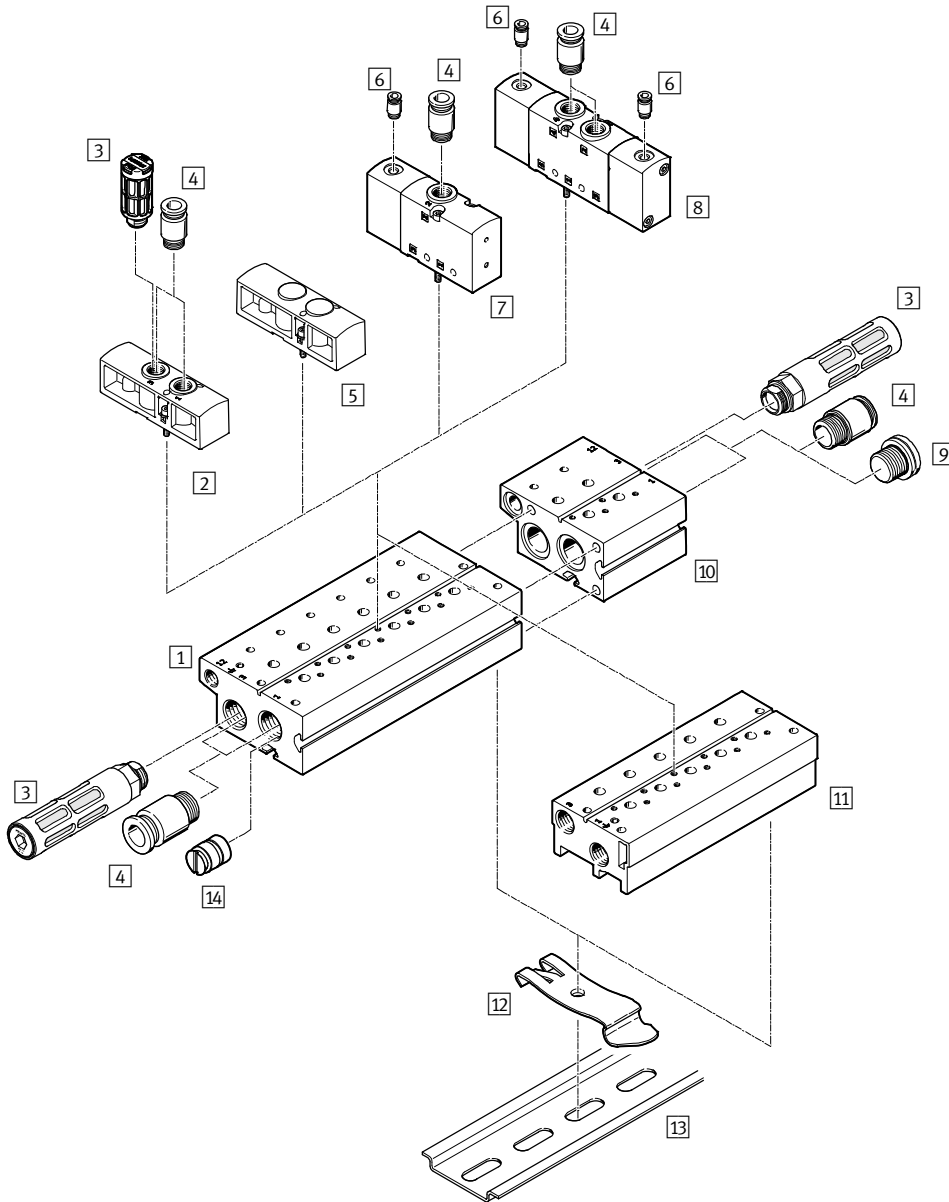

Accessories			
Description	Brief description	→ Page/Internet	
1	Standard manifold block	For 3/2-way valves	113
2	Supply plate	For 3/2-way valves	115
3	Silencer	For exhaust ports (3)	117
4	Push-in fitting	For supply/exhaust ports (1, 3)	83
5	Blanking plate	VABB-B10-...	115
6	Push-in fitting	M5 for pilot air port	83
7	Pneumatic valve	3/2-way valve	61
8	Pneumatic valve	2x 3/2-way valve (VUWS-LT...)	54
9	Blanking plug	For supply/exhaust ports (1, 3)	117
10	Standard manifold block extension module	For 3/2-way valves	113
11	Compact manifold block	For 3/2-way valves	113
12	H-rail mounting	For mounting on standard H-rails	117
13	Standard H-rail	Mounting rail to EN 60715	-
14	Separator	For creating pressure zones (in duct 1 and/or 3)	117

Pneumatic valves VUWS/valve manifold VTUS

Peripherals overview VUWS-LT, VUWS-L

Manifold block for 5/2- and 5/3-way valves

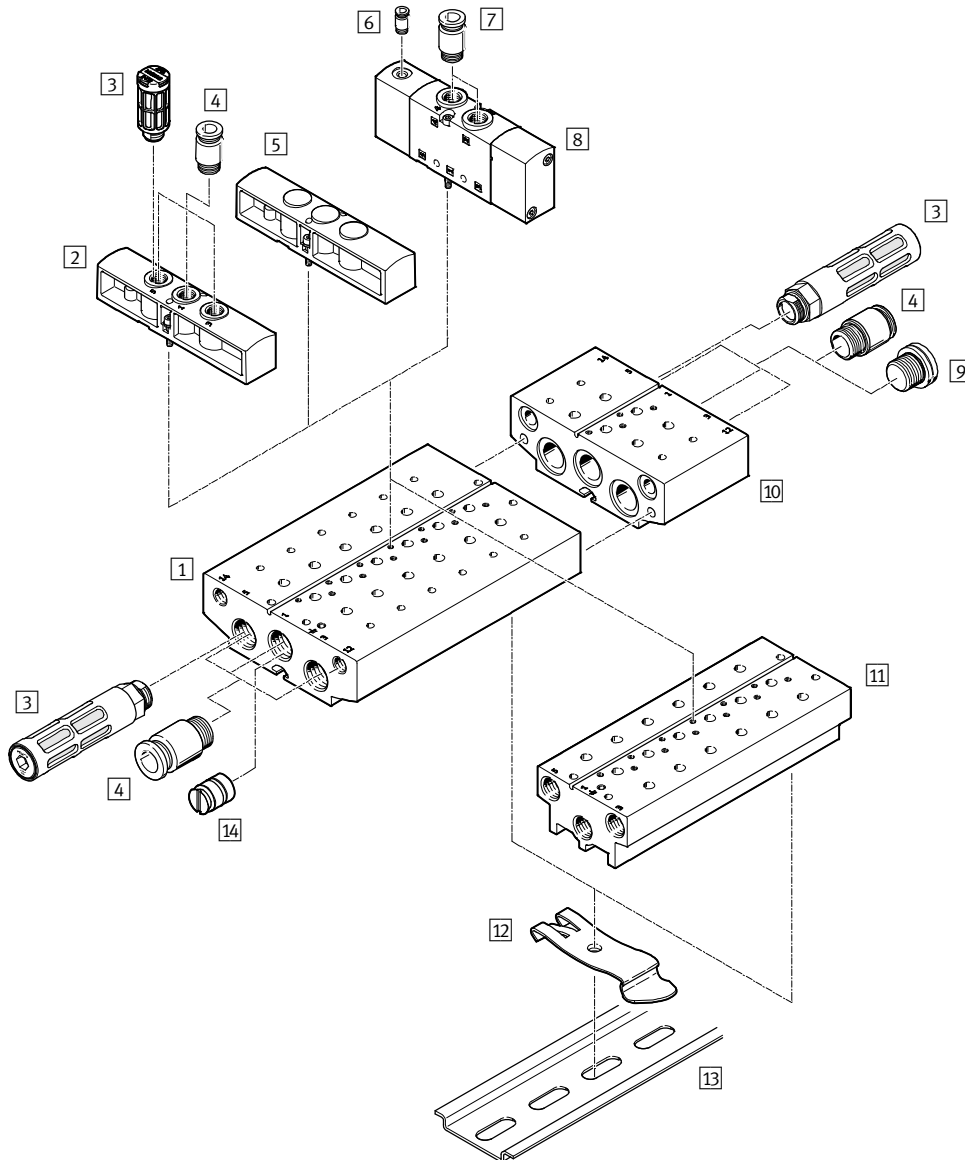

Accessories			
Description	Brief description	→ Page/Internet	
1	Standard manifold block	For 5/2- and 5/3-way valves	113
2	Supply plate	For 5/2- and 5/3-way valves	115
3	Silencer	For exhaust ports (5 and/or 3)	117
4	Push-in fitting	For supply/exhaust ports (1, 3, 5)	83
5	Blanking plate	VABB-B10-...	115
6	Push-in fitting	M5 for pilot air port	83
7	Push-in fitting	For working ports (2, 4)	83
8	Pneumatic valve	5/2-way, 5/3-way valve	61
9	Blanking plug	For supply/exhaust ports (1, 3, 5)	117
10	Standard manifold block extension module	For 5/2- and 5/3-way valves	113
11	Compact manifold block	For 5/2- and 5/3-way valves	113
12	H-rail mounting	For mounting on standard H-rails	117
13	Standard H-rail	Mounting rail to EN 60715	-
14	Separator	For creating pressure zones (in ducts 1, 3, 5)	117

Pneumatic valves VUWS/valve manifold VTUS

Peripherals overview VUWS-LT, VUWS-L

Supply manifold for mounting on both sides

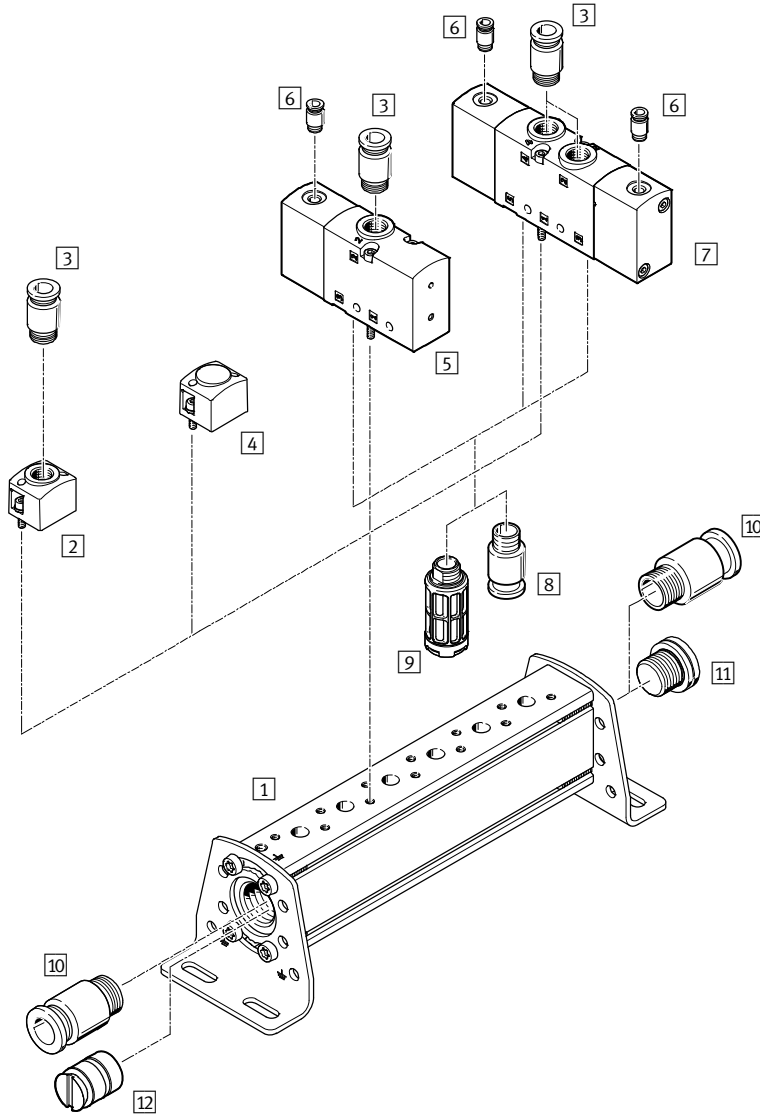

Accessories		
Description	Brief description	→ Page/Internet
1 Supply manifold	For mounting on both sides Mounting bracket can be adjusted through $\pm 30^\circ$	114
2 Supply plate	For supplying air (1) (VABF-B10-...-P1...)	115
3 Push-in fitting	For supplying air (1) for working ports (2, 4)	83
4 Blanking plate	VABB-B10-...	115
5 Pneumatic valve	3/2-way valve	82
6 Push-in fitting	M5 for pilot air port	83
7 Pneumatic valve	5/2-way, 5/3-way valve 2x 3/2-way valve (VUWS-LT...)	61 54
8 Push-in fitting	For exhaust ports (3, 5)	83
9 Silencer	For exhaust ports (3, 5)	117
10 Push-in fitting	For supplying air (1)	116
11 Blanking plug	For working port (duct 1)	117
12 Separator	For creating pressure zones (in duct 1)	117

Pneumatic valves VUWS/valve manifold VTUS

Peripherals overview VUWS-L, VUWS-LT

Supply manifold for mounting on one side

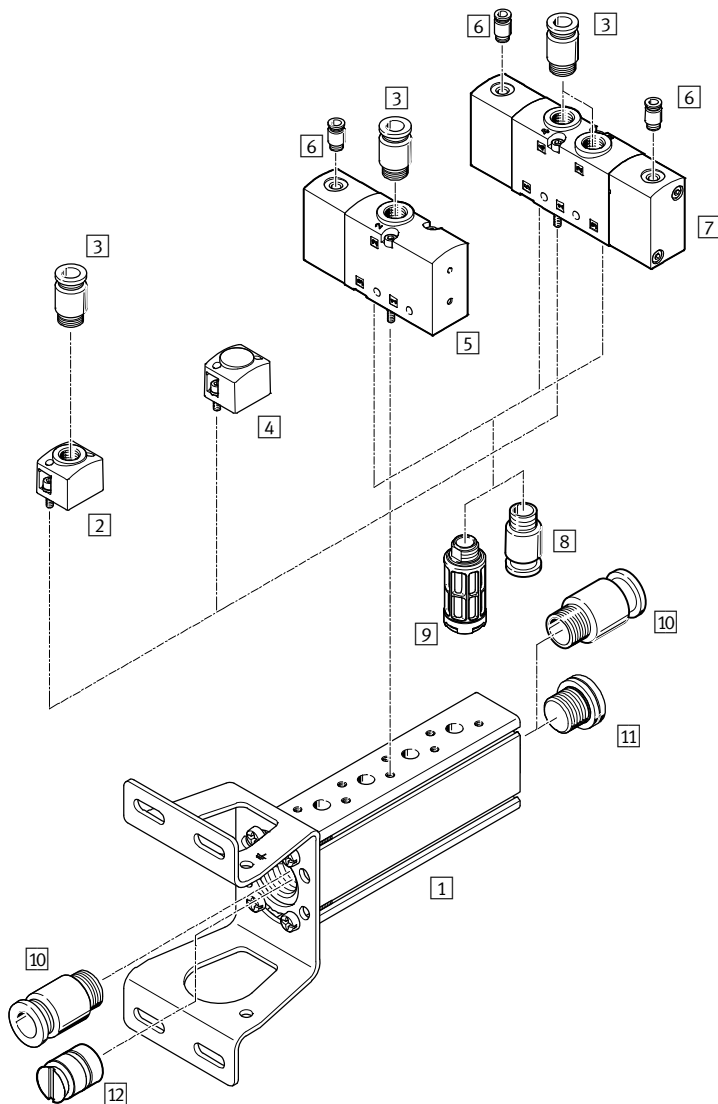

Accessories		
Description	Brief description	→ Page/Internet
1 Supply manifold	For mounting on one side Mounting bracket can be adjusted through ±30°	114
2 Supply plate	For supplying air (1) (VABF-B10...-P1...)	115
3 Push-in fitting	For supplying air (1) for working ports (2, 4)	83
4 Blanking plate	VABB-B10...	115
5 Pneumatic valve	3/2-way valve	82
6 Push-in fitting	M5 for pilot air port	83
7 Pneumatic valve	5/2-way, 5/3-way valve 2x 3/2-way valve (VUWS-LT...)	61 54
8 Push-in fitting	For exhaust ports (3, 5)	83
9 Silencer	For exhaust ports (3, 5)	117
10 Push-in fitting	For supplying air (1)	116
11 Blanking plug	For working port (duct 1)	117
12 Separator	For creating pressure zones (in duct 1)	117

Valve manifold VTUS

Technical data – Valve manifold

-  Flow rate
 - Size 20 – up to 700 l/min
 - Size 25 – up to 1300 l/min
 - Size 30 – up to 2300 l/min

-  Valve width
 - Size 20 – 21 mm
 - Size 25 – 26.5 mm
 - Size 30 – 31 mm



General technical data				
Size		20	25	30
Valve manifold configuration		Fixed grid		
Valve width [mm]		21	26.5	31
Valve design	VUWS-L	Piston spool	Piston spool	Piston spool
	VUWS-LT	Disc seat	Disc seat	Disc seat
Reset method for valves	VUWS-L	Pneumatic or mechanical spring		
	VUWS-LT	Mechanical spring		
Pneumatic spring		Internal or external		
Flow direction	VUWS-L	Reversible with restrictions		
	VUWS-LT	Non-reversible		
Suitable for vacuum	VUWS-L	Yes with restrictions		
	VUWS-LT	Yes with restrictions		
Type of control		Direct		
Manual override (MO)		None		
Lap	VUWS-L	Overlap		
	VUWS-LT	Underlap		
Sealing principle		Soft		
Max. no. of valve positions		16 (a maximum of 18 valve positions with extension for standard manifold block)		
Max. number of pressure zones		9		
Exhaust air function		With flow control		
Type of actuation		Pneumatic		
Standard nominal flow rate [qnN] [l/min]		600...700	1000...1300	1600...2300
Pilot air connection	Standard manifold block	12/14	G1/8	
	Compact manifold block	12/14	On the valve	
	Common supply manifold	12/14	On the valve	
Pilot exhaust air port		82/84	M5	
Mounting position		Any		
Materials				
Note on materials		RoHS compliant		
Information on materials - seals	VUWS-L	HNBR, NBR		
	VUWS-LT	HNBR, NBR, TPE-U(PU)		

Valve manifold VTUS

Technical data – Valve manifold

ATEX	
ATEX category for gas	II 3G
Type of ignition protection for gas	Ex ec IIC T4 X Gc
ATEX category for dust	II 3D
Type of ignition protection for dust	Ex tc IIIC T115°C X Dc
Explosion ambient temperature [°C]	-10°C ≤ Ta ≤ +60°C
CE marking (see declaration of conformity)	To EU Explosion Protection Directive (ATEX)

Operating and environmental conditions						
Valve design Size	Piston spool			Disc seat		
	20	25	30	20	25	30
Operating medium	Compressed air to ISO 8573-1:2010 [7:4:4]					
Pilot medium	Compressed air to ISO 8573-1:2010 [7:4:4]					
Note on operating/pilot medium	Lubricated operation possible (in which case lubricated operation will always be required)					
Operating pressure [bar]	-0.9 ... +10	-0.9 ... +10	-0.9 ... +10	-0.9 ... +10 (M32, T32)	-0.9 ... +10 (M32, T32)	-
	-	-	-	-	-	+1.0 ... +10 (32)
	-	-	-	+1.5 ... +10 (B52)	+1.5 ... +10 (B52)	+1.5 ... +10 (B52)
	+2.5 ... +10 (M32...-A, M32...-M, M52-A)	+2.5 ... +10 (M...-A, M52)	+2.5 ... +10 (M...-A)	+2.5 ... +10 (M52)	+2.5 ... +10 (M52)	+2.5 ... +10 (M52)
Pilot pressure [bar]	1.5 ... 10 (B52)	1.5 ... 10 (B52)	1.5 ... 10 (B52)	1.5 ... 10	1.5 ... 10 (B52)	1.5 ... 10 (B52)
	2.5 ... 10	2.5 ... 10	2.5 ... 10	2.5 ... 10 (M52)	2.5 ... 10	2.5 ... 10
Ambient temperature [°C]	-10 ... +60					
Temperature of medium [°C]	-10 ... +60					
Certification	c UL us - Recognized (OL)					
Corrosion resistance class CRC ¹⁾	2					

1) Corrosion resistance class CRC 2 to Festo standard FN 940070
Moderate corrosion stress. Indoor applications in which condensation may occur. External visible parts with primarily decorative requirements for the surface and which are in direct contact with the ambient atmosphere typical for industrial applications.

Valve manifold VTUS

Technical data

Dimensions

Download CAD data → www.festo.com

With 3/2-way valves, standard manifold rail

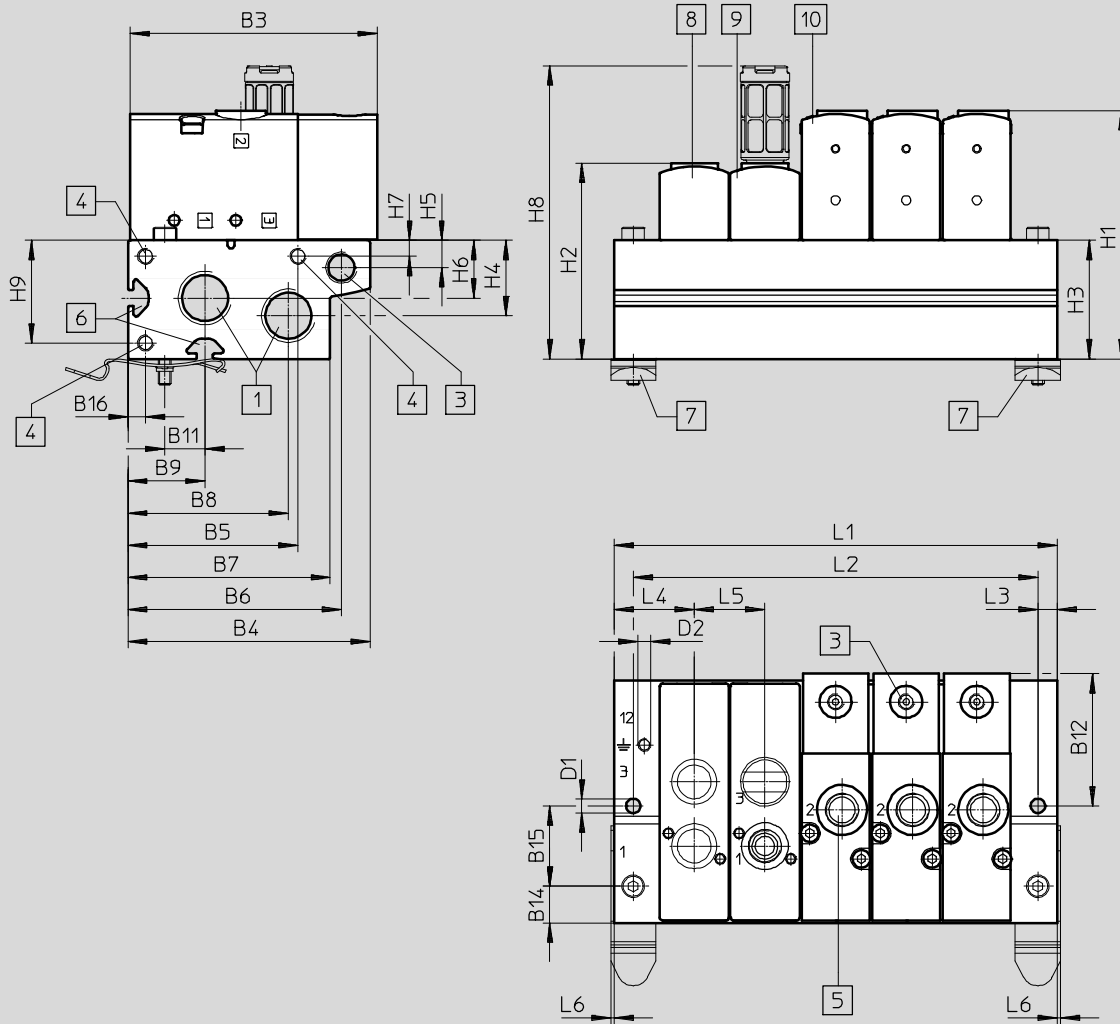

- | | | | |
|---|---|---|--|
| <p>1 Ports 1 and 3 (at both ends):
G3/8 for VTUS 20
G1/2 for VTUS 25
G3/4 for VTUS 30</p> <p>3 Port 12 on the manifold block at both ends: G1/8
Port 10 and 12 on the valve:
M5 for VTUS 20,
M5 for VTUS 25,
G1/8 for VTUS 30</p> | <p>4 Thread for extension module:
M5x15.5 for VTUS 20
M5x18 for VTUS 25
M5x18 for VTUS 30</p> <p>5 Port 2:
G1/8 for VTUS 20
G1/4 for VTUS 25
G3/8 for VTUS 30</p> | <p>6 Profile slot IPM-05, system 5</p> <p>7 H-rail mounting VAME-T-M4 for VTUS 20
VAME-T-M5 for VTUS 25
VAME-T-M6 for VTUS 30</p> <p>8 Blanking plate</p> | <p>9 Supply plate, ports 1 and 3:
G1/8 for VTUS 20
G1/4 for VTUS 25
G3/8 for VTUS 30</p> <p>10 3/2-way valve</p> |
|---|---|---|--|

-  - Note

Port 12 on the manifold rail (number 3 in the dimensional drawing) is not used when equipped with pneumatic valves.

Valve manifold VTUS

Technical data

Type	B3	B4	B5	B6	B7	B8	B9	B11	B12	B14	B15	B16
VTUS-20	77	75.5	53	66.5	63	50	24	12.5	41.2	11.5	25	5.5
VTUS-25	92	93	67.5	80.5	78	62	30	16	-	14	32	6
VTUS-30	109.2	108.2	79	93.2	94.7	75.7	36.2	19	55.5	17.2	38	6.5

Type	D1 Ø	D2	H1	H2	H3	H4	H5	H6	H7	H8	H9	L3	L4	L5	L6
VTUS-20	4.5	M4x6.5	77.4	61	37	23.5	8.5	18	5	91.4	32	6	25	22	1
VTUS-25	5.5	M4x9	95.5	71	45	25	9	22	5	123.4	39	6	29.8	27.5	1
VTUS-30	6.3	M5x11	118	91	61	35	9	28.5	6.5	170.1	54.5	7.2	34	32	-

Valve positions	2	3	4	5	6	7	8	9	10	
VTUS-20	L1 [mm]	72	94	116	138	160	182	204	226	248
	L2 [mm]	60	82	104	126	148	170	192	214	236
VTUS-25	L1 [mm]	87	114.5	142	169.5	197	224.5	252	279.5	307
	L2 [mm]	75	102.5	130	157.5	185	212.5	240	267.5	295
VTUS-30	L1 [mm]	100	132	164	196	228	260	292	324	356
	L2 [mm]	85	117	149	181	213	245	277	309	341

Valve manifold VTUS

Technical data – Valve manifold

Dimensions – Valve manifold

Download CAD data → www.festo.com

With 3/2-way valves, compact manifold rail

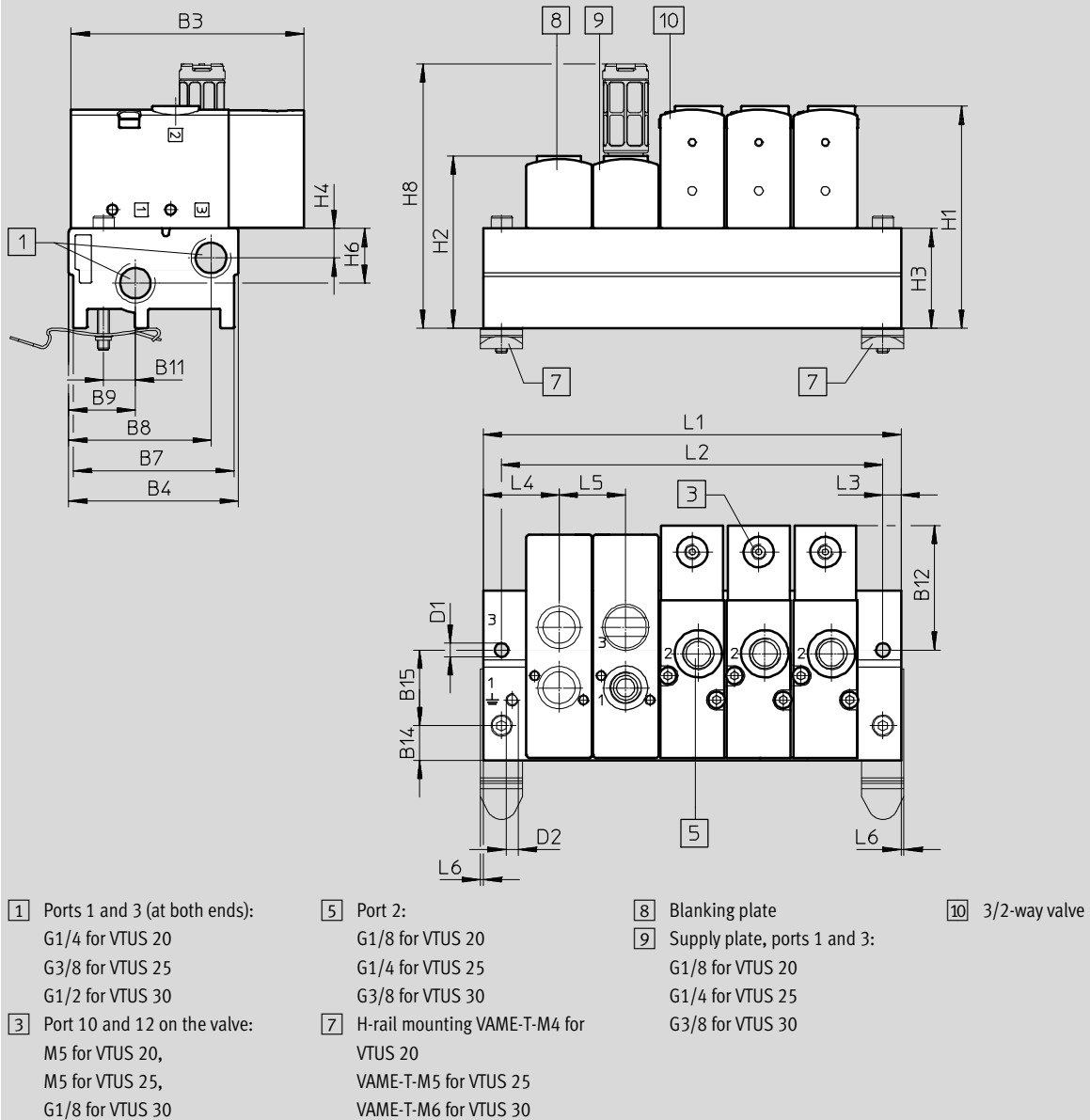

Valve manifold VTUS

Technical data – Valve manifold

Type	B3	B4	B7	B8	B9	B11	B12	B14	B15
VTUS-20	77	56.1	53.1	47	22	10.5	41.2	11.5	25
VTUS-25	92	70.3	67.3	58.8	30	16	47	14	32
VTUS-30	109.2	83	80	69.4	36	19	55.5	17	38

Type	D1 Ø	D2	H1	H2	H3	H4	H6	H8	L3	L4	L5	L6
VTUS-20	4.5	M4x6.5	73.4	57	33	9.7	18	87.4	6	25	22	1
VTUS-25	5.5	M4x9	84.5	60	34	13.5	20	112.4	6	29.8	27.5	1
VTUS-30	6.3	M5x11	99.5	72.5	42.5	17.5	26	151.6	7.5	38	32	-

Valve positions	2	3	4	5	6	7	8	9	10	
VTUS-20	L1 [mm]	72	94	116	138	160	182	204	226	248
	L2 [mm]	60	82	104	126	148	170	192	214	236
VTUS-25	L1 [mm]	87	114.5	142	169.5	197	224.5	252	279.5	307
	L2 [mm]	75	102.5	130	157.5	185	212.5	240	267.5	295
VTUS-30	L1 [mm]	100	132	164	196	228	260	292	324	356
	L2 [mm]	85	117	149	181	213	245	277	309	341

Valve manifold VTUS

Technical data – Valve manifold

Dimensions – Valve manifold

Download CAD data → www.festo.com

With 5/2-, 5/3- and 2x 3/2-way valves, standard manifold rail

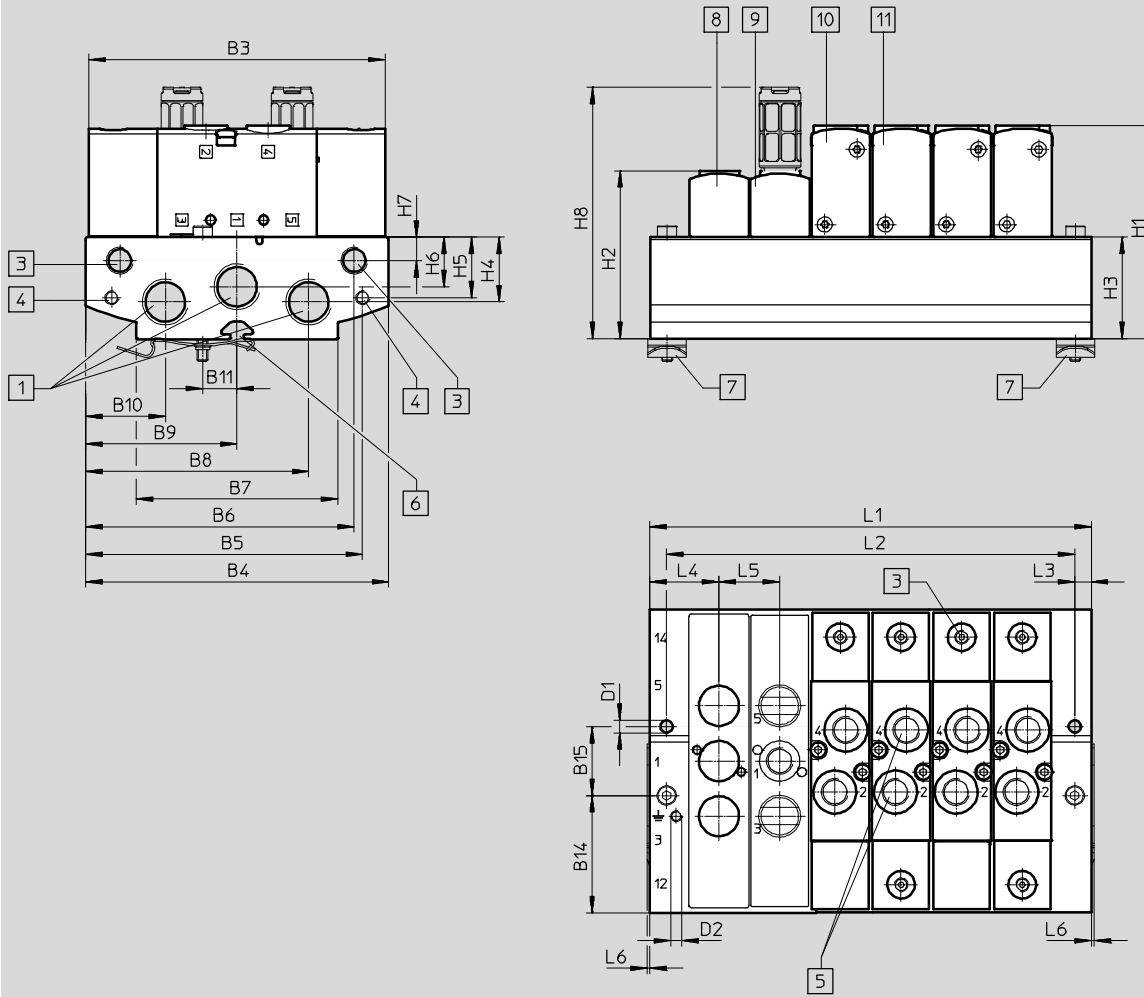

- | | | | |
|---|--|---|--|
| <p>1 Ports 1, 3 and 5 (at both ends):
G3/8 for VTUS 20
G1/2 for VTUS 25
G3/4 for VTUS 30</p> <p>3 Port 12 and 14 on the manifold block at both ends:
G1/8
Port 12 and 14 on the valve:
M5 for VTUS 20,
M5 for VTUS 25,
G1/8 for VTUS 30</p> | <p>4 Thread for extension module:
M5x15.5 for VTUS 20
M5x18 for VTUS 25
M5x18 for VTUS 30</p> <p>5 Ports 2 and 4: G1/8 for VTUS 20
G1/4 for VTUS 25
G3/8 for VTUS 30</p> | <p>6 Profile slot IPM-05, system 5</p> <p>7 H-rail mounting VAME-T-M4 for VTUS 20
VAME-T-M5 for VTUS 25
VAME-T-M6 for VTUS 30</p> | <p>9 Supply plate, ports 1, 3 and 5:
G1/8 for VTUS 20
G1/4 for VTUS 25
G3/8 for VTUS 30</p> <p>10 5/2-way valve, monostable</p> <p>11 5/2-way valve, bistable or 5/3-way valve or 2x 3/2-way valve</p> |
|---|--|---|--|

Note

Port 12 on the manifold rail (number 3 in the dimensional drawing) is not used when equipped with pneumatic valves.

Valve manifold VTUS

Technical data – Valve manifold

Type	B3	B4	B5	B6	B7	B8	B9	B10	B11	B14	B15
VTUS-20	107.4	110	100.5	97.5	73	81	55	29	12.5	42.5	25
VTUS-25	126	126	119	113.5	80	95	63	31	16	47	32
VTUS-30	149	144	137	129	104	111.5	72	32.5	19	53	38

Type	D1 Ø	D2	H1	H2	H3	H4	H5	H6	H7	H8	L3	L4	L5	L6
VTUS-20	4.5	M4x6.5	77.4	61	37	23.5	22	18	8.5	91.4	6	25	22	1
VTUS-25	5.5	M4x9	95.5	71	45	25	22	22	9	123.4	6	29.8	27.5	1
VTUS-30	6.3	M5x11	118	91	61	35	22	28.5	9	170.1	7.5	34	32	-

Valve positions	2	3	4	5	6	7	8	9	10	
VTUS-20	L1 [mm]	72	94	116	138	160	182	204	226	248
	L2 [mm]	60	82	104	126	148	170	192	214	236
VTUS-25	L1 [mm]	87	114.5	142	169.5	197	224.5	252	279.5	307
	L2 [mm]	75	102.5	130	157.5	185	212.5	240	267.5	295
VTUS-30	L1 [mm]	100	132	164	196	228	260	292	324	356
	L2 [mm]	85	117	149	181	213	245	277	309	341

Valve manifold VTUS

Technical data – Valve manifold

Dimensions – Valve manifold

Download CAD data → www.festo.com

With 5/2-, 5/3- and 2x 3/2-way valves, compact manifold rail

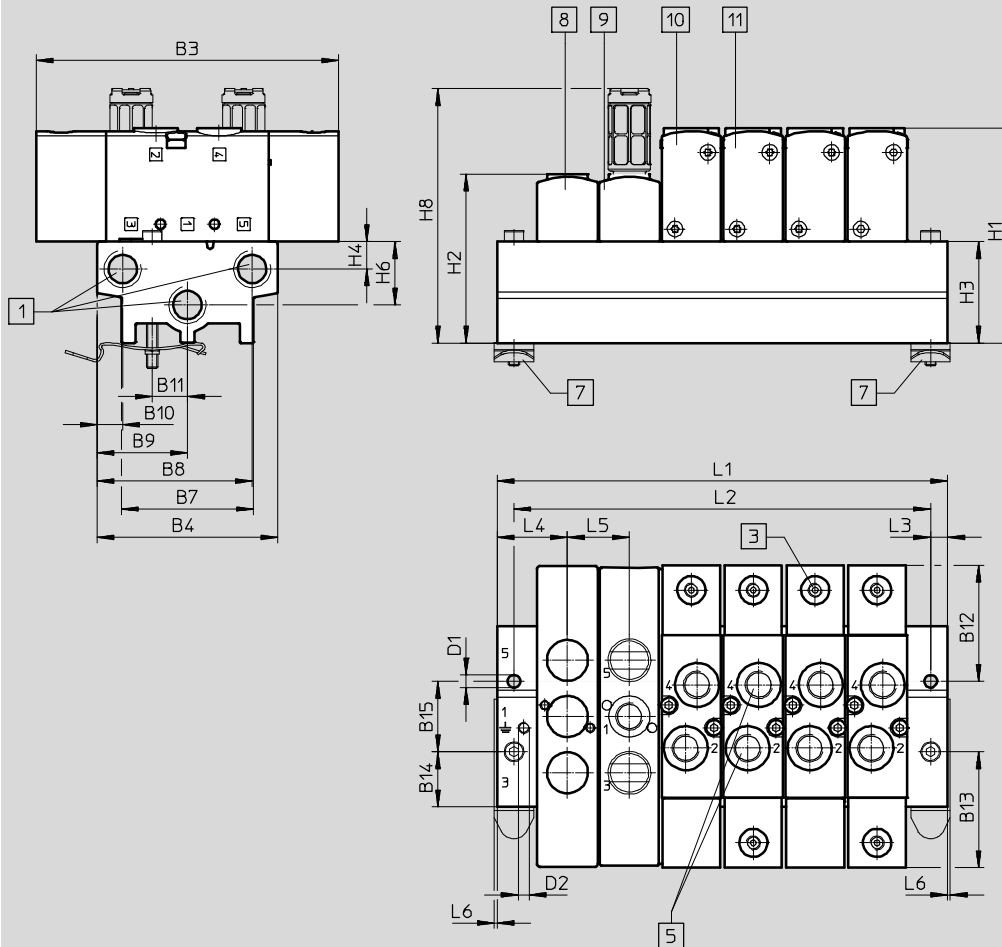

- | | | | |
|---|---|---|--|
| <p>1 Ports 1, 3 and 5 (at both ends):
G1/4 for VTUS 20
G3/8 for VTUS 25
G1/2 for VTUS 30</p> <p>3 Port 12 and 14 on the valve:
M5 for VTUS 20,
M5 for VTUS 25,
G1/8 for VTUS 30</p> | <p>5 Ports 2 and 4: G1/8 for VTUS 20
G1/4 for VTUS 25
G3/8 for VTUS 30</p> <p>7 H-rail mounting VAME-T-M4 for VTUS 20
VAME-T-M5 for VTUS 25
VAME-T-M6 for VTUS 30</p> | <p>8 Blanking plate</p> <p>9 Supply plate, ports 1, 3 and 5:
G1/8 for VTUS 20
G1/4 for VTUS 25
G3/8 for VTUS 30</p> | <p>10 5/2-way valve, monostable</p> <p>11 5/2-way valve, bistable or 5/3-way valve or 2x 3/2-way valve</p> |
|---|---|---|--|



Valve manifold VTUS

Technical data – Valve manifold

Type	B3	B4	B7	B8	B9	B10	B11	B12	B13	B14	B15
VTUS-20	107.4	64.2	47	55.1	32.1	9.1	12.5	41.2	41.2	19.6	25
VTUS-25	126	80.5	61.5	69	40.3	11.5	16	47	47	24.3	32
VTUS-30	149	94	77	80.4	47	13.6	19	55.5	55.5	28	38

Type	D1 Ø	D2	H1	H2	H3	H4	H6	H8	L3	L4	L5	L6
VTUS-20	4.5	M4x6.5	76.4	60	36	9.7	22.5	90.4	6	25	22	1
VTUS-25	5.5	M4x9	84.5	60	34	13.5	20	112.1	6	29.8	27.5	1
VTUS-30	6.3	M5x11	99.5	72.5	42.5	17.5	26	151.6	7.5	34	32	-

Valve positions	2	3	4	5	6	7	8	9	10	
VTUS-20	L1 [mm]	72	94	116	138	160	182	204	226	248
	L2 [mm]	60	82	104	126	148	170	192	214	236
VTUS-25	L1 [mm]	87	114.5	142	169.5	197	224.5	252	279.5	307
	L2 [mm]	75	102.5	130	157.5	185	212.5	240	267.5	295
VTUS-30	L1 [mm]	100	132	164	196	228	260	292	324	356
	L2 [mm]	85	117	149	181	213	245	277	309	341

Valve manifold VTUS

Technical data – Valve manifold

Dimensions – Supply manifold

Download CAD data → www.festo.com

Mounting on both sides

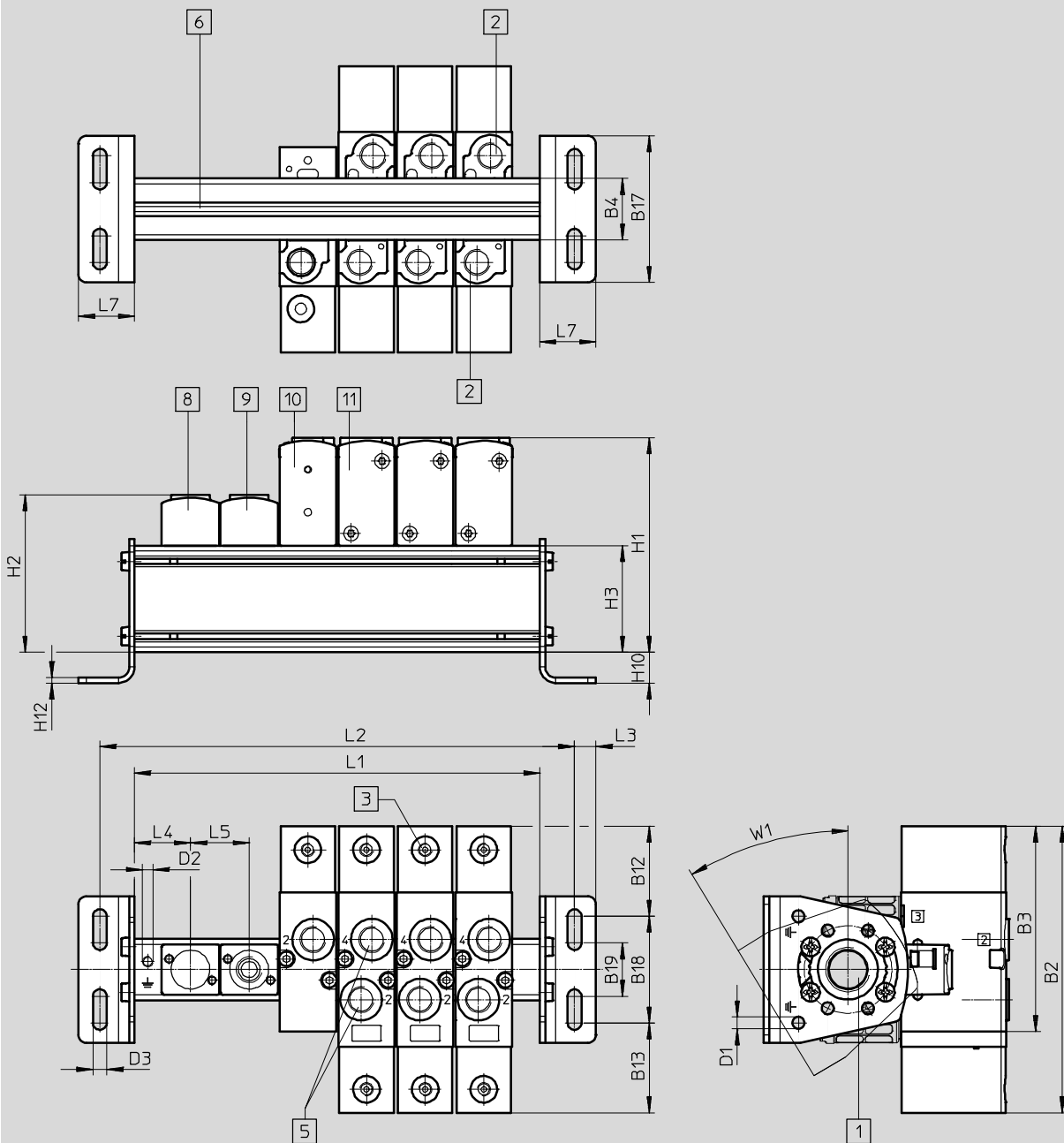

- 1 Port 1 (at both ends):
G3/8 for VTUS 20
G1/2 for VTUS 25
G3/4 for VTUS 30
- 2 Ports 3 and 5: G1/8 for VTUS 20
G1/4 for VTUS 25
G3/8 for VTUS 30

- 3 Port 12 and 14 on the valve:
M5 for VTUS 20,
M5 for VTUS 25,
G1/8 for VTUS 30
- 5 Ports 2 and 4:
G1/8 for VTUS 20
G1/4 for VTUS 25
G3/8 for VTUS 30
- 6 Profile slot IPM-05, system 5

- 8 Blanking plate
- 9 Supply plate, port 1:
G1/8 for VTUS 20,
G1/4 for VTUS 25
G3/8 for VTUS 30
- 10 3/2-way valve
- 11 5/2-way valve, bistable
or 5/3-way valve or
2x 3/2-way valve

- - Note
Mounting bracket can be adjusted
through ±30°

Valve manifold VTUS

Technical data – Valve manifold

Type	B2	B3	B4	B12	B13	B17	B18	B19	H1	H2	H3
VTUS-20	107.4	77	23	33.7	33.7	55	40	20	80.4	59	40
VTUS-25	126	92	28.7	33	33	75	60	35	102.5	78	52
VTUS-30	149	109.2	34	42	42	85	65	35	122	95	65

Type	H10	H12	D1 Ø	D2	D3 Ø	L3	L4	L5	L7	W1
VTUS-20	11.5	2	4.5	M4x6.5	5.2	9	21	22	22	31.3°
VTUS-25	18	2	4.5	M4x9	6.6	8	29.8	27.5	24	30°
VTUS-30	17.5	2.5	5.5	M5x11	8.6	9	34	32	26	28°

Valve positions	2	3	4	5	6	7	8	9	10	
VTUS-20	L1 [mm]	64	86	108	130	152	174	196	218	240
	L2 [mm]	90	112	134	156	178	200	222	244	266
VTUS-25	L1 [mm]	87	114.5	142	169.5	197	224.5	252	279.5	307
	L2 [mm]	119	156.5	174	201.5	229	256.5	284	311.5	339
VTUS-30	L1 [mm]	100	132	164	196	228	260	292	324	356
	L2 [mm]	134	166	198	230	262	294	326	358	390

Valve manifold VTUS

Technical data – Valve manifold

Dimensions – Supply manifold

Download CAD data → www.festo.com

Mounting on one side

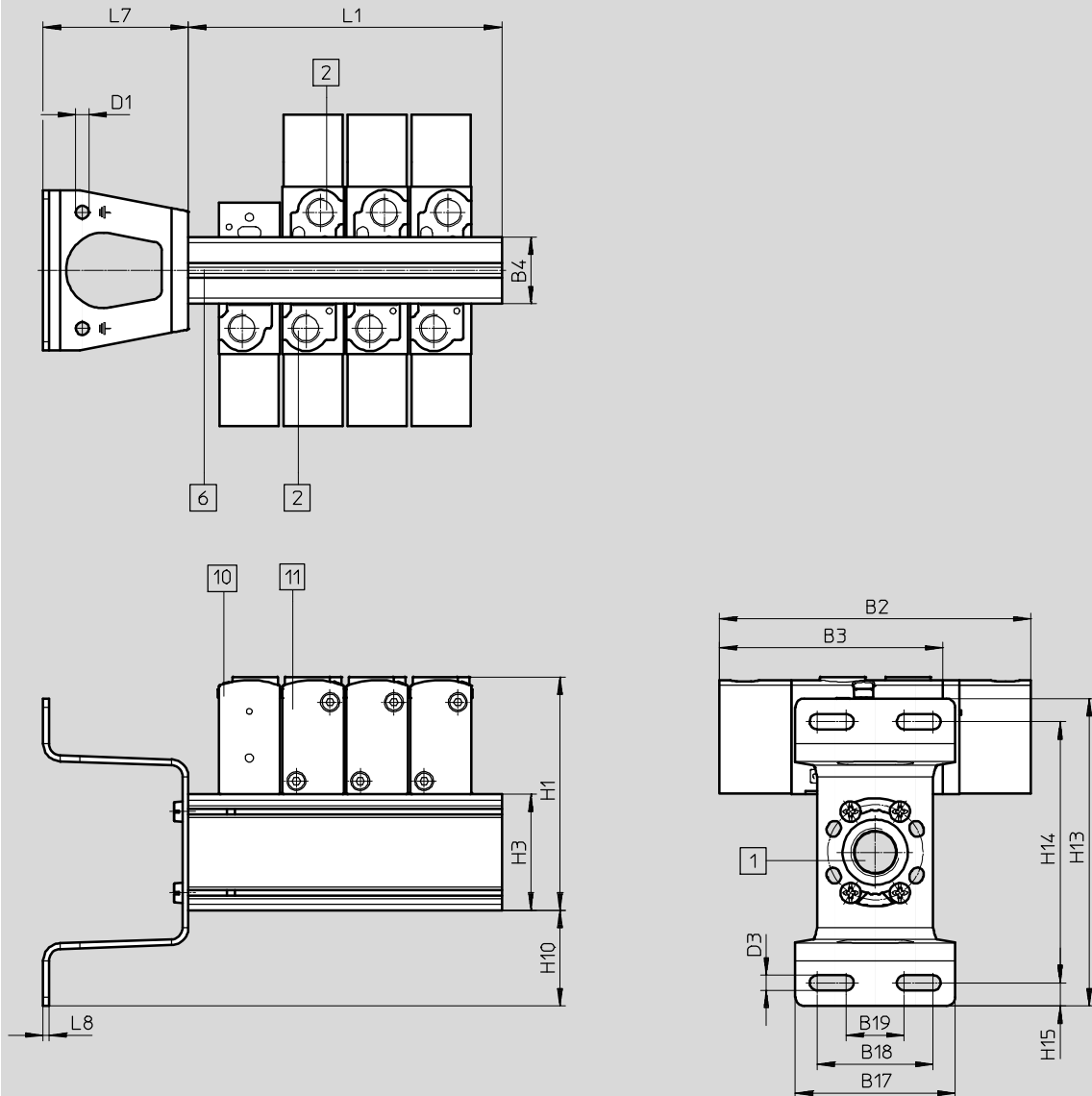

1 Port 1 (at both ends):
G3/8 for VTUS 20
G1/2 for VTUS 25
G3/4 for VTUS 30

2 Ports 3 and 5:
G1/8 for VTUS 20
G1/4 for VTUS 25
G3/8 for VTUS 30

6 Profile slot IPM-05, system 5

10 3/2-way valve
11 5/2-way valve, bistable
or 5/3-way valve or
2x 3/2-way valve

 Note
Mounting bracket can be adjusted
through ±30°

Valve manifold VTUS

Technical data – Valve manifold

Type	B2	B3	B4	B17	B18	B19
VTUS-20	107.4	77	23	55	40	20
VTUS-25	126	92	28.7	80	60	35
VTUS-30	149	109.2	34	85	65	35

Type	D1 Ø	D3 Ø	H1	H3	H10	H13	H14	H15	L7	L8
VTUS-20	4.5	5.2	80.4	40	33	107	89	8	50	2
VTUS-25	4.5	6.6	102.5	52	38	128	112	8	64	2
VTUS-30	5.5	8.6	122	65	38	146	128	9	74	2.5

Valve positions	2	3	4
VTUS-20 L1 [mm]	64	86	108
VTUS-25 L1 [mm]	87	114.5	142
VTUS-30 L1 [mm]	100	132	164

Pneumatic valves VUWS

Order code – Pneumatic valves

VUWS	-	L		-		
Type of directional control valve						
In-line valve		L				
Design principle						
Piston spool with sealing cartridge		-				
Poppet valve, soft seal		T				
Size						
Valve width	21 mm		20			
	26.5 mm		25			
	31 mm		30			
Valve functions						
3/2-way valve, normally closed					M32C	
3/2-way valve, normally open					M32U	
2x 3/2-way valve, normally closed					T32C	
2x 3/2-way valve, normally open					T32U	
2x 3/2-way valve, normally 1x open, 1x closed					T32H	
5/2-way valve, monostable					M52	
5/2-way valve, bistable					B52	
5/3-way valve, mid-position closed					P53C	
5/3-way valve, mid-position pressurised					P53U	
5/3-way valve, mid-position exhausted					P53E	

Exhausting	
-	Without fitting
QN	With fitting
U1	Silencer with metal housing
U3	Silencer with polymer housing
U5	Silencer with sintered housing
Pneumatic connection	
G18	Thread G 1/8
G14	Thread G 1/4
G38	Thread G 3/8
Q4	Push-in connector 4 mm
Q6	Push-in connector 6 mm
Q8	Push-in connector 8 mm
Q10	Push-in connector 10 mm
Q12	Push-in connector 12 mm
Type of reset	
-	None (for bistable valves)
A	Pneumatic spring
E	Pneumatic spring, external
M	Mechanical spring

Pneumatic valves VUWS-LT, size 20

Technical data

-  - Flow rate
Up to 600 l/min (±20%)

-  - Valve width
21 mm



General technical data								
Valve function	3/2-way valve			2x 3/2-way valve			5/2-way valve	
Order code for valves	M32C	M32U	T32C	T32U	T32H	M52	B52	
Valve width [mm]	21							
Design	Disc seat							
Pneumatic spring supply	Internal							
Type of control	Direct							
Manual override (MO)	None							
Flow direction	Non-reversible							
Overlap	Underlap							
Sealing principle	Soft							
Type of mounting	Optionally via through-holes ¹⁾ or on manifold rail							
Standard nominal flow rate qnN [l/min]	600	600	600	600	600	500	500	
Through-holes (nominal width) [mm]	5.2	5.2	5.2	5.2	5.2	5	5	
Product weight [g]	117	119	189	191	190	173	192	
Actuation type	Pneumatic							
Mounting position	Any							
Exhaust air function	With flow control option							
Venting hole	Not ducted							
Pneumatic connection	1, 2, 3	G1/8	G1/8	G1/8	G1/8	G1/8	G1/8	G1/8
	4, 5	-	-	G1/8	G1/8	G1/8	G1/8	G1/8
Pneumatic spring connection 12/14, 10	M5							

1) If several valves are to be screwed together via the through-holes to form a block, a minimum distance of 0.3 mm must be ensured by placing spacer discs between them.
2) With external pneumatic spring: 190 g, with internal pneumatic spring or mechanical spring: 178 g

Pneumatic valves VUWS-LT, size 20

Technical data

Technical data – 3/2-way valves			
Order code for valves		M32C	M32U
Normal position		Closed	Open
Stable position		Monostable	Monostable
Reset method		Mechanical spring	Mechanical spring
Switching times in [ms]	On	6	6
	Off	19	18
	Change-over	–	–

Technical data – 5/2-way valves			
Order code for valves		M52	B52
Stable position		Monostable	Bistable
Reset method		Mechanical spring	–
Switching times in [ms]	On	10	–
	Off	14	–
	Change-over	–	4

Technical data – 2x 3/2-way valves				
Order code for valves		T32C	T32U	T32H
Stable position		Monostable		
Reset method		Mechanical spring		
Switching times in [ms]	On	6	6	6
	Off	19	18	19

Safety characteristics	
Shock resistance	Shock test with severity level 2 to FN 942017-5 and EN 60068-2-27
Vibration resistance	Transport application test with severity level 2 to FN 942017-4 and EN 60068-2-6

Operating and environmental conditions					
Valve function		M32	M52	B52	T32
Operating medium		Compressed air to ISO 8573-1:2010 [7:4:4]			
Pilot medium		Compressed air to ISO 8573-1:2010 [7:4:4]			
Note about the operating/pilot medium		Lubricated operation possible (in which case lubricated operation will always be required)			
Operating pressure	[bar]	–0.9 ... +10	2.5 ... 10	1.5 ... 10	–0.9 ... +10
Pilot pressure	[bar]	1.5 ... 10	2.5 ... 10	1.5 ... 10	1.5 ... 10
Ambient temperature	[°C]	–5 ... +60			
Temperature of medium	[°C]	–5 ... +60			
Approval certificate		c UL us - Recognized (OL)			
Corrosion resistance class CRC ¹⁾		2			

1) Corrosion resistance class CRC 2 to Festo standard FN 940070
Moderate corrosion stress. Indoor applications in which condensation may occur. External visible parts with primarily decorative requirements for the surface and which are in direct contact with the ambient atmosphere typical for industrial applications.

Information on materials	
Housing	Die-cast aluminium (coated)
Seals	HNBR, NBR, TPE-U(PU)
Screws	Galvanised steel
Note on materials	RoHS-compliant

Pneumatic valves VUWS-LT, size 20

Technical data

Dimensions

Download CAD data → www.festo.com

3/2-way valve

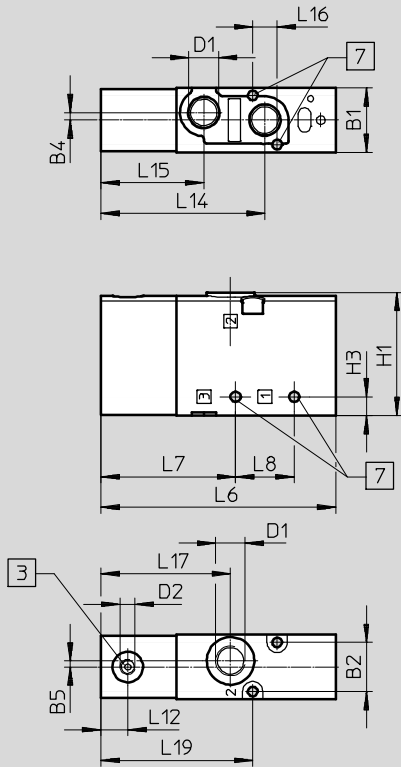

- 3 Connection 10 for pilot air (VUWS-LT20-M32U)
Connection 12 for pilot air (VUWS-LT20-M32C)
- 7 For retaining screw M3

Type	B1	B2	B4	B5	D1	D2	H1	H3
VUWS-LT20-M32-...-G18	21.1	16.1	2.5	2	G1/8	M5	40.4	6.2

Type	L6	L7	L8	L12	L14	L15	L16	L17	L19
VUWS-LT20-M32-...-G18	77	44.1	19.2	8.8	53.7	33.7	8	42.5	49.7

Pneumatic valves VUWS-LT, size 20

Technical data

Dimensions

Download CAD data → www.festo.com

5/2-way valve, monostable

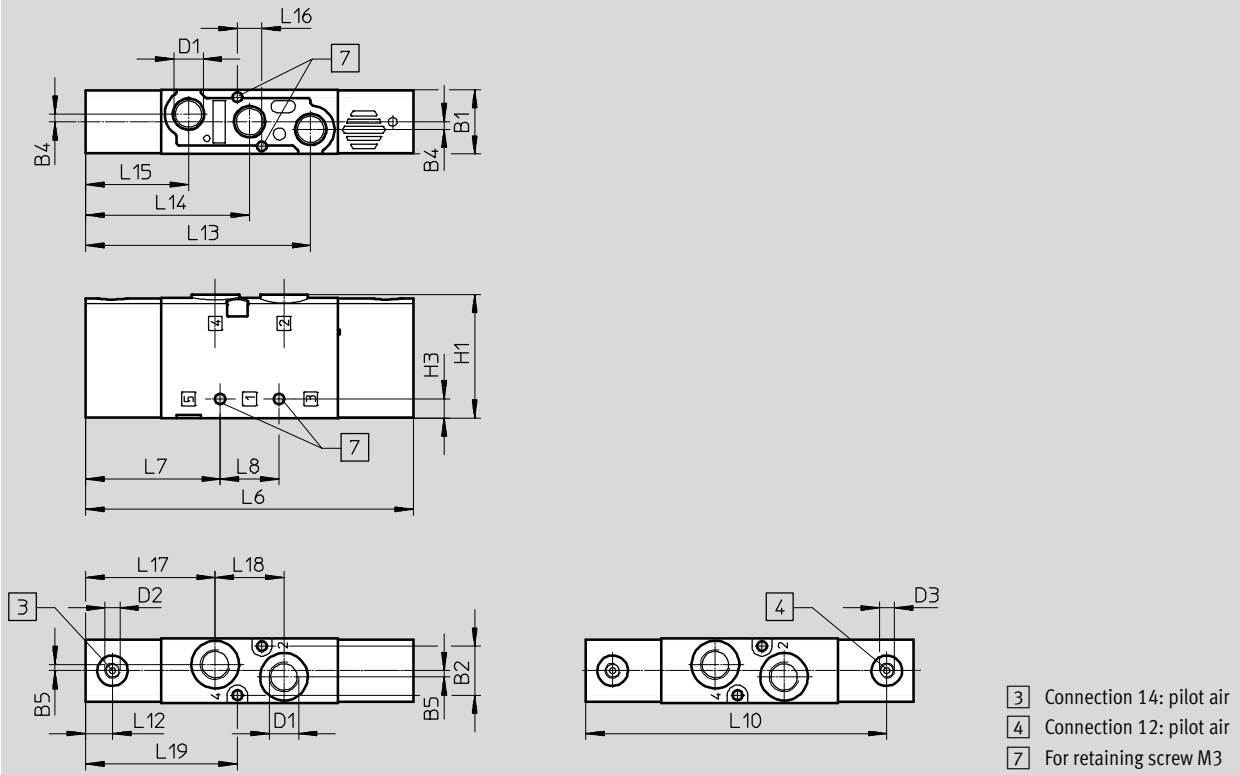

Type	B1	B2	B4	B5	D1	D2	D3	H1	H3	L6
VUWS-LT20-M52-M...-G18	21.1	16.1	2.5	2	G1/8	M5	-	40.4	6.2	107.4

Type	L10	L7	L8	L12	L13	L14	L15	L16	L17	L18	L19
VUWS-LT20-M52-M...-G18	-	44.1	19.2	8.8	73.7	53.7	33.7	8	42.5	22.5	49.7

Pneumatic valves VUWS-LT, size 20

Technical data

Dimensions

Download CAD data → www.festo.com

2x 3/2-way valve and 5/2-way valve, bistable

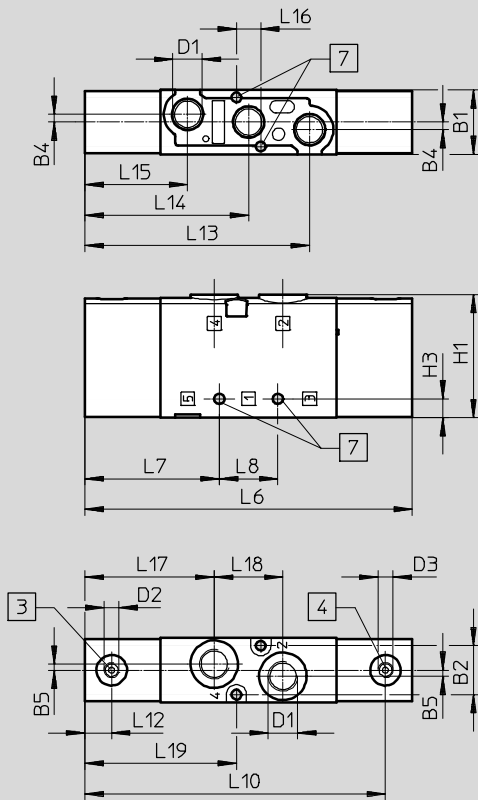

- 3 Connection 14: pilot air
- 4 Connection 12: pilot air
- 7 For retaining screw M3

Type	B1	B2	B4	B5	D1	D2	D3	H1	H3
VUWS-LT20-T32-...-M-G18	21.1	16.1	2.5	2	G1/8	M5	M5	40.4	6.2
VUWS-LT20-B52-G18									

Type	L6	L7	L8	L10	L12	L13	L14	L15	L16	L17	L18	L19
VUWS-L20-T32-...-M-G18	107.4	44.1	19.2	98.6	8.8	73.7	53.7	33.7	8	42.5	22.5	49.7
VUWS-LT20-B52-G18												

Pneumatic valves VUWS-LT, size 20

Technical data

Dimensions

Foot mounting

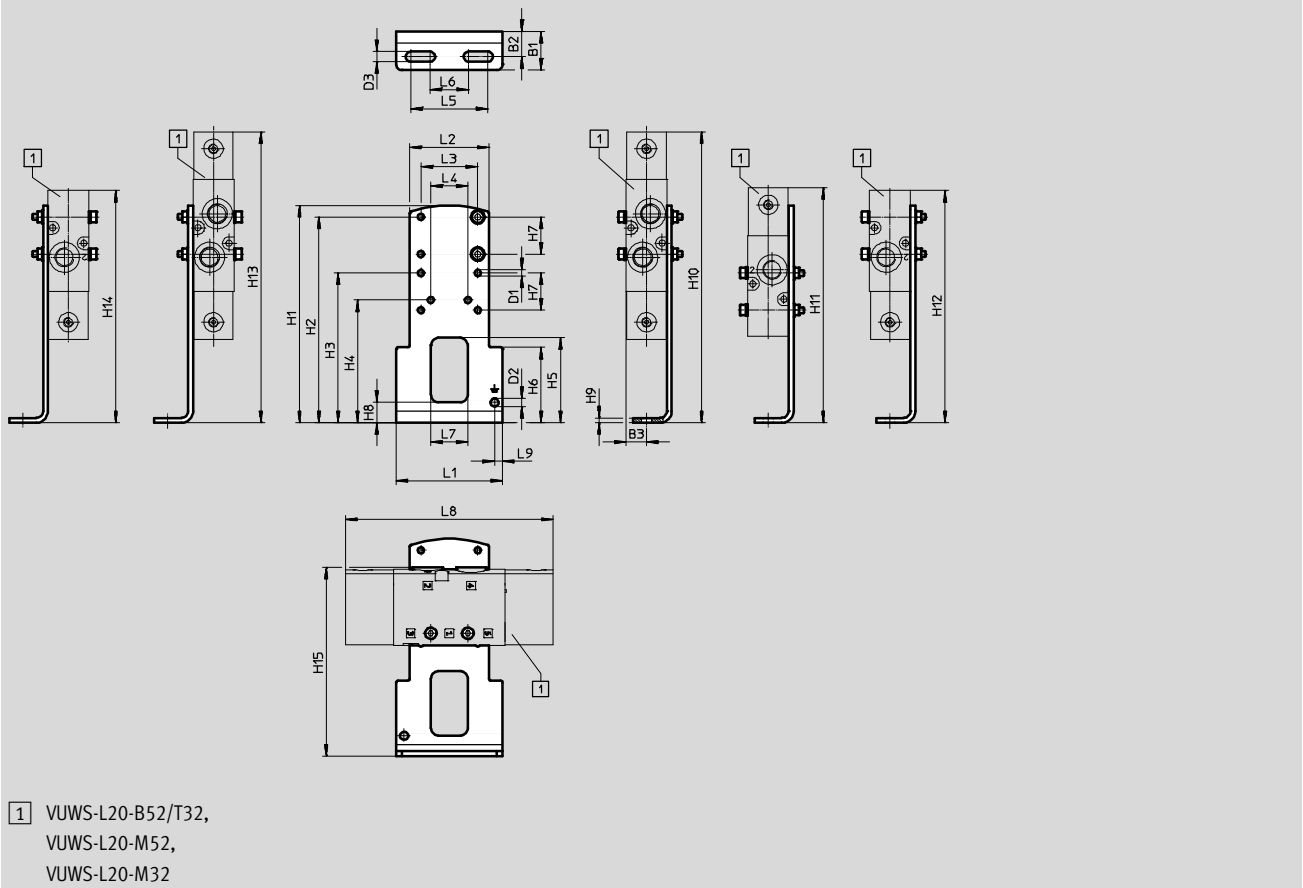

Type		B1	B2	B3	D1 ∅	D2 ∅	D3 ∅	H1	H2	H3	H4
VAME-B10-20-A	VUWS-LT20-B52/T32	20	13.1	10.6	3.2	4.2	5.2	112.5	106.5	77.5	63.5
	VUWS-L20-M52										
	VUWS-L20-M32										

Type		H5	H6	H7	H8	H9	H10	H11	H12	H13	H14
VAME-B10-20-A	VUWS-LT20-B52/T32	44	39	19.2	10.5	2.5	150.6	121.6	150.6	150.6	150.6
	VUWS-LT20-M52								120.2		
	VUWS-LT20-M32										

Type		H15	L1	L2	L3	L4	L5	L6	L7	L8	L9
VAME-B10-20-A	VUWS-LT20-B52/T32	97.7	55	41	29.4	19.2	40	20	19	107.4	4.1
	VUWS-LT20-M52									77	
	VUWS-LT20-M32										

Pneumatic valves VUWS-LT, size 20

Technical data

Dimensions

Wall mounting

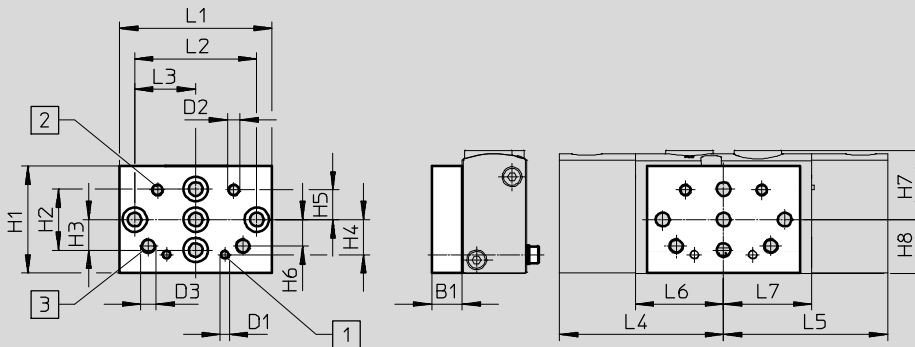

1 Mounting hole for size 20 2 Mounting hole for size 25 3 Mounting hole for size 30

Type		B1	D1	D2	D3	H1	H2	H3	H4	H5	H6
VAME-B10-20-W	VUWS-LT20-B52/T32	10	M3	M4	M5	35	20	10	11.5	9.7	8.7
	VUWS-LT20-M52										
	VUWS-LT20-M32										

Type		H7	H8	L1	L2	L3	L4	L5	L6	L7
VAME-B10-20-W	VUWS-LT20-B52/T32	22.7	17.7	50	40	20	53.7	53.7	28.9	28.9
	VUWS-LT20-M52									
	VUWS-LT20-M32									



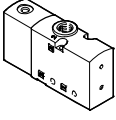
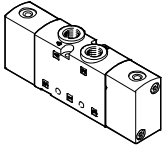
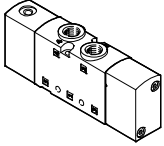

Pneumatic valves VUWS-LT, size 20

Ordering data – Pneumatic valves, size 20

Ordering data				
	Code	Valve function	Part No.	Type
3/2-way valve				
	Normally closed, monostable			
	M32C	Reset via mechanical spring, internal pilot air supply, flow direction not reversible	577525	VUWS-LT20-M32C-M-G18
	Normally open, monostable			
	M32U	Reset via pneumatic spring, internal pilot air supply, flow direction not reversible	577526	VUWS-LT20-M32U-M-G18
2x 3/2-way valve				
	Monostable, normally closed			
	T32C	Reset via mechanical spring, internal pilot air supply, flow direction not reversible	577529	VUWS-LT20-T32C-M-G18
	Monostable, normally open			
	T32U	Reset via mechanical spring, internal pilot air supply, flow direction not reversible	577531	VUWS-LT20-T32H-M-G18
	Monostable, 1x normally open, 1x normally closed			
T32H	Reset via mechanical spring, internal pilot air supply, flow direction not reversible	577530	VUWS-LT20-T32U-M-G18	
5/2-way valve				
	Monostable			
	M52-M	Reset via mechanical spring, internal pilot air supply, flow direction not reversible	577527	VUWS-LT20-M52-M-G18
	Bistable			
B52	Internal pilot air supply, flow direction not reversible	577528	VUWS-LT20-B52-G18	

Pneumatic valves VUWS-LT, size 20

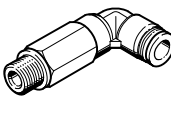
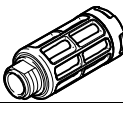
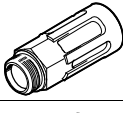

Accessories

Ordering data					
	Description		Part No.	Type	PU ¹⁾
Push-in fitting with internal hexagon					
	Connecting thread M5 for tubing O.D.	4 mm	153315	QSM-M5-4-I	10
	Connecting thread G1/8 for tubing O.D.	4 mm	186106	QS-G1/8-4-I	10
		4 mm	133008	QS-G1/8-4-I-100	100
		6 mm	186107	QS-G1/8-6-I	10
			133009	QS-G1/8-6-I-100	100
		8 mm	186109	QS-G1/8-8-I	10
			133010	QS-G1/8-8-I-100	100
Angled push-in fitting with external hexagon					
	Connecting thread G1/8 for tubing O.D.	4 mm	186116	QSL-G1/8-4	10
			132048	QSL-G1/8-4-100	100
		6 mm	186117	QSL-G1/8-6	10
			132049	QSL-G1/8-6-100	100
		8 mm	186119	QSL-G1/8-8	10
			132050	QSL-G1/8-8-50	50
Angled push-in fitting, long, with external hexagon					
	Connecting thread G1/8 for tubing O.D.	4 mm	186127	QSL-G1/8-4	10
			133015	QSL-G1/8-4-100	100
		6 mm	186128	QSL-G1/8-6	10
			133016	QSL-G1/8-6-100	100
		8 mm	186130	QSL-G1/8-8	10
			133017	QSL-G1/8-8-100	100
Silencers					
	With connecting thread G, polymer design	G1/8	2307	U-1/8	1
			534222	U-1/8-50	50
	With connecting thread G, metal design	G1/8	6841	U-1/8-B	1
	With connecting thread G, sintered design, long	G1/8	1205860	AMTE-M-LH-G18	20

1) Packaging unit

Pneumatic valves VUWS-LT, size 20

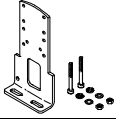
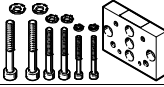
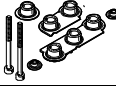
Accessories

Ordering data			
Description	Weight [g]	Part No.	Type
Foot mounting			
	Set for mounting valves, comprising: <ul style="list-style-type: none"> • Mounting bracket and • Screw set for mounting 	97	576412 VAME-B10-20-A
Wall mounting			
	Set for mounting valves for size 20, 25, 30, comprising: <ul style="list-style-type: none"> • Wall mounting and • Screw set for mounting 	53	576413 VAME-B10-20-W
Assortment of spare parts			
	Set comprising: <ul style="list-style-type: none"> • Seals and • Screws 	10	8026203 VAME-B10-20-MK
Inscription label			
	40 pieces in frame	-	565306 ASLR-C-E4

Pneumatic valves VUWS-LT, size 25

FESTO

Technical data

-  - Flow rate
Up to 1000 l/min (±20%)

-  - Valve width
26.5 mm



General technical data								
Valve function	3/2-way valve			2x 3/2-way valve			5/2-way valve	
Order code for valves	M32C	M32U	T32C	T32U	T32H	M52	B52	
Valve width [mm]	26.5							
Design	Disc seat							
Type of control	Direct							
Manual override (MO)	None							
Flow direction	Non-reversible							
Lap	Underlap							
Sealing principle	Soft							
Type of mounting	Optionally via through-holes or on manifold rail							
Standard nominal flow rate qnN [l/min]	1000							
Through-holes (nominal width) [mm]	6.9	6.6	6.9	6.9	6.9	6.6	6.6	
Product weight [g]	221	255	343	411	377	317	344	
Actuation type	Pneumatic							
Mounting position	Any							
Exhaust air function	With flow control							
Connection for breathing opening	Not ducted							
Pneumatic connection	1, 2, 3	G1/4	G1/4	G1/4	G1/4	G1/4	G1/4	G1/4
	4, 5	-	-	G1/4	G1/4	G1/4	G1/4	G1/4
Pneumatic spring connection 12/14, 10	M5							

Technical data – 3/2-way valves						
Order code for valves	M32C	M32U	T32C	T32U	T32H	
Normal position	Closed	Open	Closed	Open	1x closed, 1x open	
Stable position	Monostable					
Reset method	Mechanical spring					
Switching times [ms]	On	6	7	6	7	7
	Off	29	30	29	30	30

Pneumatic valves VUWS-LT, size 25

Technical data

Technical data – 5/2-way valves		
Order code for valves	M52	B52
Stable position	Monostable	Bistable
Reset method	Mechanical spring	–
Switching times [ms]	On	8
	Off	23
	Change-over	–
		6

Safety data	
Shock resistance	Shock test with severity level 2 to FN 942017-5 and EN 60068-2-27
Vibration resistance	Transport application test with severity level 2 to FN 942017-4 and EN 60068-2-6

Operating and environmental conditions				
Order code for valves	M32	T32	M52	B52
Operating medium	Compressed air to ISO 8573-1:2010 [7:4:4]			
Pilot medium	Compressed air to ISO 8573-1:2010 [7:4:4]			
Note on operating/pilot medium	Lubricated operation possible (in which case lubricated operation will always be required)			
Operating pressure [bar]	–0,9 ... 10	–0,9 ... 10	2.5 ... 10	1.5 ... 10
Pilot pressure [bar]	2.5 ... 10	2.5 ... 10	2.5 ... 10	1.5 ... 10
Ambient temperature [°C]	–5 ... +60	–5 ... +60	–10 ... +60	–10 ... +60
Temperature of medium [°C]	–5 ... +60	–5 ... +60	–10 ... +60	–10 ... +60
Certification	c UL us - Recognized (OL)			
Corrosion resistance ¹⁾	2			

1) Corrosion resistance class CRC 2 to Festo standard FN 940070
Moderate corrosion stress. Indoor applications in which condensation may occur. External visible parts with primarily decorative requirements for the surface and which are in direct contact with the ambient atmosphere typical for industrial applications.

Information on materials	
Housing	Die-cast aluminium (painted)
Seals	HNBR, NBR, TPE-U(PU)
Screws	Galvanised steel
Note on materials	RoHS compliant

Pneumatic valves VUWS-LT, size 25

Technical data

Dimensions

Download CAD data → www.festo.com

3/2-way valve

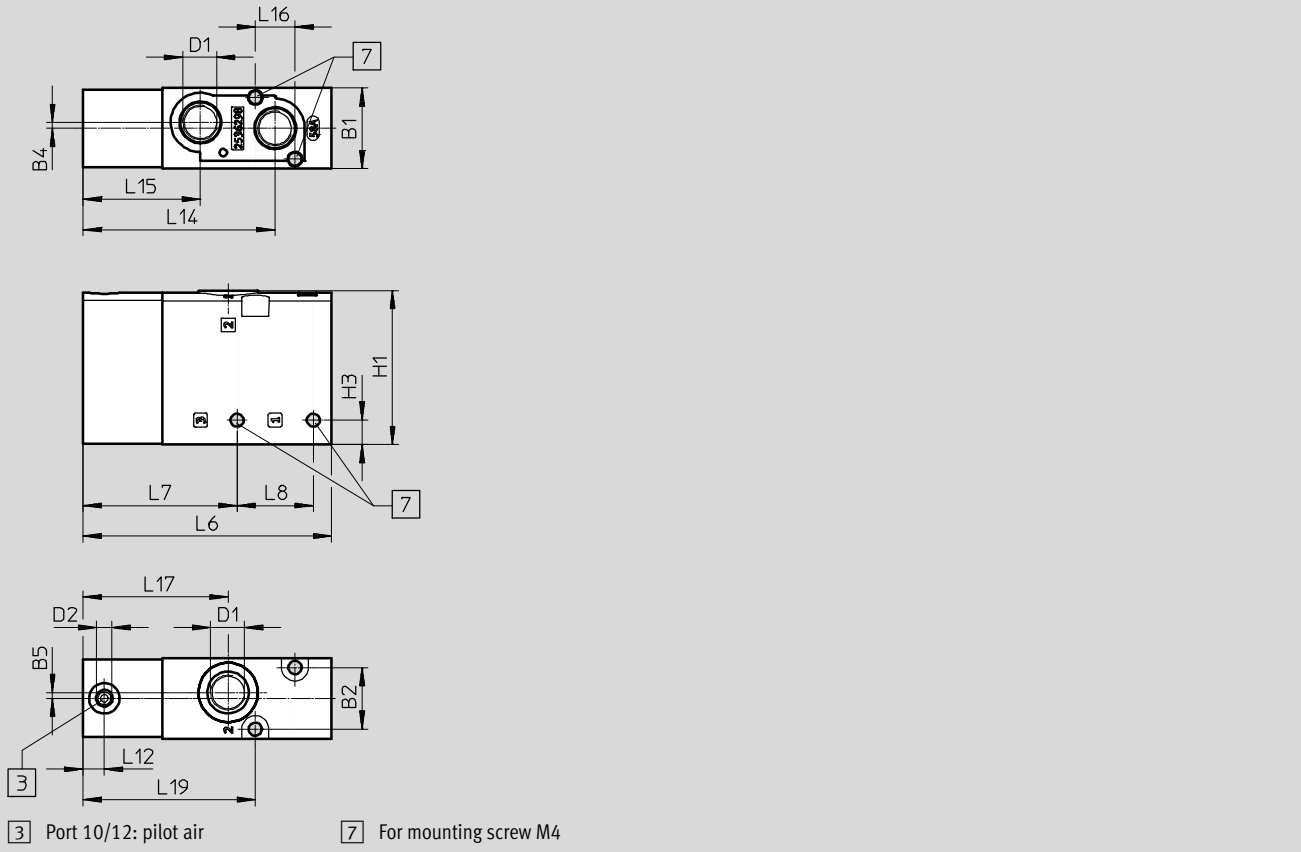

Type	B1	B2	B4	B5	D1	D2	H1	H3
VUWS-LT25-M32...-M-G14	26.5	20.2	1.9	1.9	G1/4	M5	50.5	8

Type	L6	L7	L8	L12	L14	L15	L16	L17	L19
VUWS-LT25-M32...-M-G14	81.6	50.5	25	7	63	38.5	13	47.6	56.5

Pneumatic valves VUWS-LT, size 25

Technical data

Dimensions

Download CAD data → www.festo.com

5/2-way valve, monostable

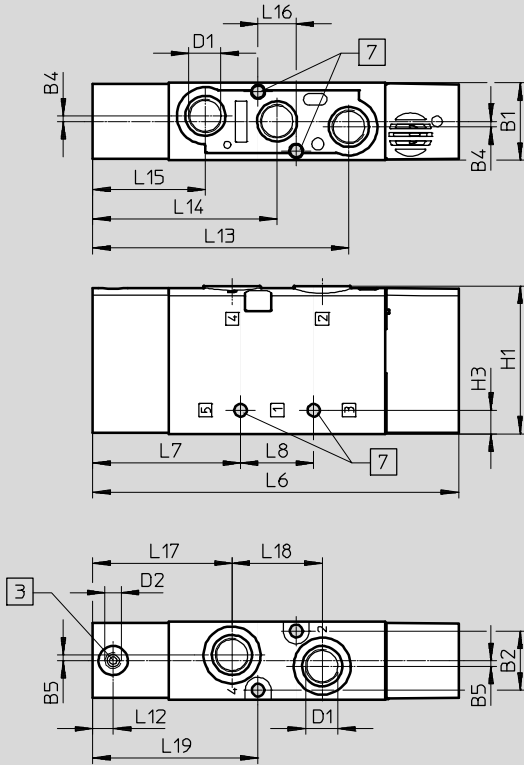

3 Port 14: pilot air 7 For mounting screw M4

Type	B1	B2	B4	B5	D1	D2	H1	H3
VUWS-LT25-M52-M-G14	26.5	20.2	1.9	1.9	G1/4	M5	50.5	8

Type	L6	L7	L8	L12	L13	L14	L15	L16	L17	L18	L19
VUWS-LT25-M52-M-G14	125	50.5	25	7	87.5	63	38.5	13	47.6	30.8	56.5

Pneumatic valves VUWS-LT, size 25

Technical data

Dimensions

Download CAD data → www.festo.com

2x 3/2-way valve and 5/2-way valve, bistable

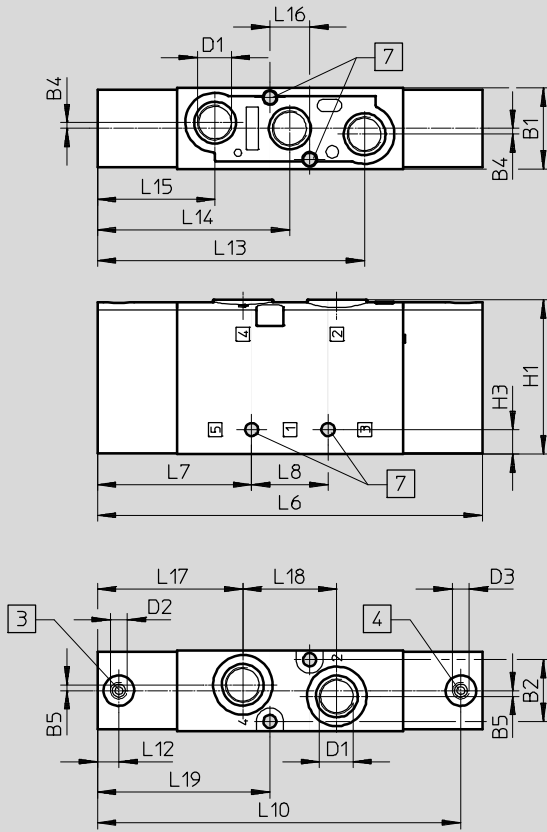

- 3 Port 14: pilot air
- 4 Port 12: pilot air
- 7 For mounting screw M4

Type	B1	B2	B4	B5	D1	D2	D3	H1	H3
VUWS-LT25-B52-G14	26,5	20,2	1,9	1,9	G1/4	M5	M5	50,5	8
VUWS-LT25-T32...-M-G14									

Type	L6	L7	L8	L10	L12	L13	L14	L15	L16	L17	L18	L19
VUWS-LT25-B52-G14	126	50,5	25	119	7	87,5	63	38,5	13	47,6	30,8	56,5
VUWS-LT25-T32...-M-G14												

Pneumatic valves VUWS-LT, size 25

Accessories

Dimensions

Download CAD data → www.festo.com

Foot mounting

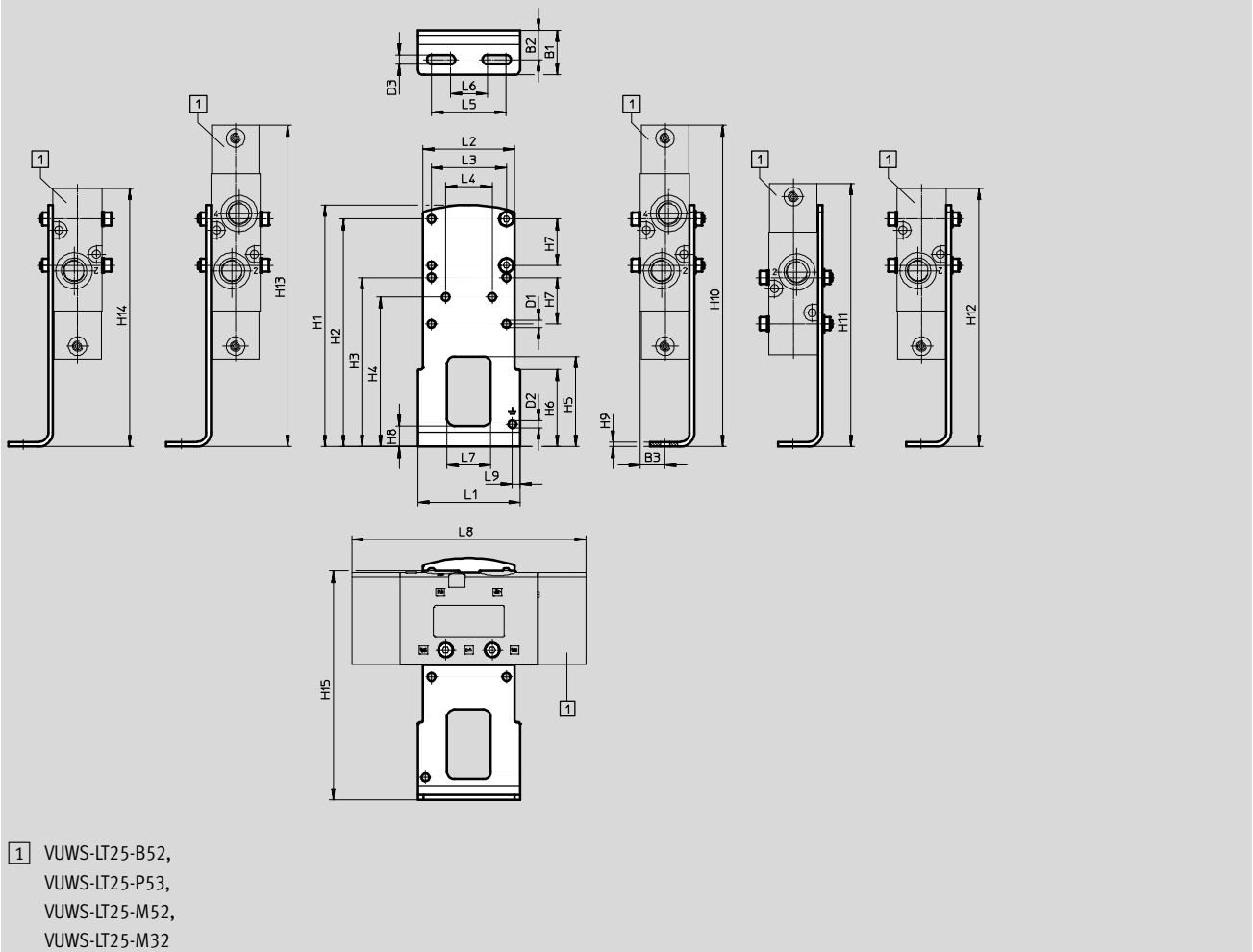

Type		B1	B2	B3	D1 ∅	D2 ∅	D3 ∅	H1	H2	H3	H4
VAME-B10-25-A	VUWS-LT25-B52/T32	24	15.8	13.3	4.2	4.2	5.2	130	122.5	91	80.5
	VUWS-LT25-M52										
	VUWS-LT25-M32										

Type		H5	H6	H7	H8	H9	H10	H11	H12	H13	H14
VAME-B10-25-A	VUWS-LT25-B52/T32	48.5	41.5	25	11	2.5	173	141.5	173	173	173
	VUWS-LT25-M52								172		172
	VUWS-LT25-M32								128.5		128.5

Type		H15	L1	L2	L3	L4	L5	L6	L7	L8	L9
VAME-B10-25-A	VUWS-LT25-B52/T32	123	55	49.4	40.4	25	40	20	23.5	126	4.1
	VUWS-LT25-M52									125	
	VUWS-LT25-M32									81.5	

Pneumatic valves VUWS-LT, size 25

Accessories

Dimensions Download CAD data → www.festo.com

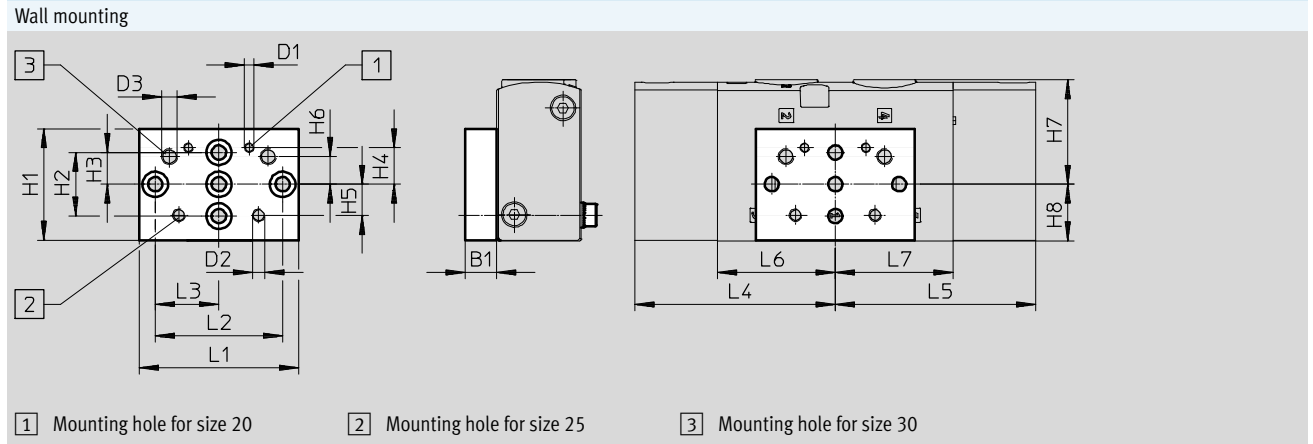

Type		B1	D1	D2	D3	H1	H2	H3	H4	H5	H6
VAME-B10-20-W	VUWS-LT25-B52/T32	10	M3	M4	M5	35	20	10	11.5	9.7	8.7
	VUWS-LT25-M52										
	VUWS-LT25-M32										

Type		H7	H8	L1	L2	L3	L4	L5	L6	L7
VAME-B10-20-W	VUWS-LT25-B52/T32	32.8	17.7	50	40	20	63	63	37	37
	VUWS-LT25-M52									
	VUWS-LT25-M32									





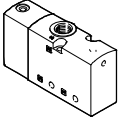
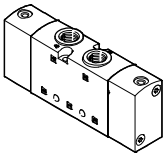
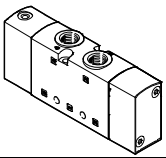
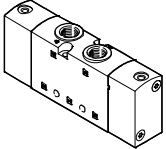

Pneumatic valves VUWS-LT, size 25

Accessories

Ordering data – Pneumatic valves				
	Code	Valve function	Part No.	Type
3/2-way valve				
	Normally closed, monostable			
	M32C-M	Reset via mechanical spring, internal pilot air supply, direction of flow not reversible	8035173	VUWS-LT25-M32C-M-G14
	Normally open, monostable			
	M32U-M	Reset via mechanical spring, internal pilot air supply, direction of flow not reversible	8035180	VUWS-LT25-M32U-M-G14
2x 3/2-way valve				
	Normally closed, monostable			
	T32C	Reset via mechanical spring, internal pilot air supply, direction of flow not reversible	8035201	VUWS-LT25-T32C-M-G14
	Normally open, monostable			
	T32U	Reset via mechanical spring, internal pilot air supply, direction of flow not reversible	8035208	VUWS-LT25-T32U-M-G14
Normally 1x open, 1x closed, monostable				
T32H	Reset via mechanical spring, internal pilot air supply, direction of flow not reversible	8035215	VUWS-LT25-T32H-M-G14	
5/2-way valve				
	Monostable			
	M52-M	Reset via mechanical spring, direction of flow not reversible	8035187	VUWS-LT25-M52-M-G14
	Bistable			
	B52	Direction of flow not reversible	8035194	VUWS-LT25-B52-G14

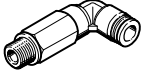
Pneumatic valves VUWS-LT, size 25

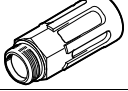

Accessories

Ordering data					
	Description		Part No.	Type	PU ¹⁾
Push-in fitting with internal hex					
	Connecting thread M5 for tubing O.D.	4 mm	153315	QSM-M5-4-I	10
	Connecting thread G1/4 for tubing O.D.	6 mm	186108	QS-G1/4-6-I	10
		8 mm	186110	QS-G1/4-8-I	10
		10 mm	186112	QS-G1/4-10-I	10
Angled push-in fitting with external hex					
	Connecting thread G1/4 for tubing O.D.	6 mm	186118	QSL-G1/4-6	10
			132051	QSL-G1/4-6-100	100
		8 mm	186120	QSL-G1/4-8	10
			132052	QSL-G1/4-8-50	50
		10 mm	186122	QSL-G1/4-10	10
			132053	QSL-G1/4-10-50	50
Angled push-in fitting, long, with external hex					
	Connecting thread G1/4 for tubing O.D.	6 mm	186129	QSL-L-G1/4-6	10
		8 mm	186131	QSL-L-G1/4-8	10
		10 mm	186133	QSL-L-G1/4-10	10
Silencers					
	With connecting thread G, polymer design	G1/4	2316	U-1/4	1
			534223	U-1/4-20	20
	With connecting thread G, metal design	G1/4	6842	U-1/4-B	1
	With connecting thread G, sintered design, long	G1/4	1205861	AMTE-M-LH-G14	20

1) Packaging unit

Pneumatic valves VUWS-LT, size 25

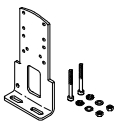
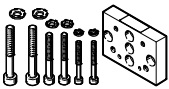
Accessories

Ordering data				
	Description	Weight [g]	Part No.	Type
Foot mounting				
	With screw set for attaching the valve to the foot mounting	130	2293485	VAME-B10-25-A
Wall mounting				
	With screw set for attaching the valve to the wall mounting	53	576413	VAME-B10-20-W
Set of spare parts				
	Set comprising seals and screws	12	8035636	VAME-B10-25-MK
Inscription label				
	40 pieces in frame	–	565306	ASLR-C-E4

Pneumatic valves VUWS-LT, size 30

Technical data

Flow rate
Up to 1800 l/min (±20%)

Valve width
31 mm



General technical data							
Valve function	3/2-way valve		2x 3/2-way valve			5/2-way valve	
Order code for valves	M32C	M32U	T32C	T32U	T32H	M52	B52
Valve width [mm]	31						
Design	Disc seat						
Type of control	Direct						
Manual override (MO)	None						
Flow direction	Non-reversible						
Overlap	Underlap						
Sealing principle	Soft						
Type of mounting	Optionally via through-holes or on manifold rail						
Standard nominal flow rate qnN [l/min]	1600	1600	1600	1600	1600	1800	1800
Through-holes (nominal width) [mm]	7.9	7.9	7.9	7.8	7.8	8.1	8.7
Product weight [g]	345	352	515	533	524	473	521
Actuation type	Pneumatic						
Mounting position	Optional						
Exhaust air function	With flow control option						
Connection for venting hole	Not ducted						
Pneumatic connection	1, 2, 3	G3/8	G3/8	G3/8	G3/8	G3/8	G3/8
	4, 5	-	-	G3/8	G3/8	G3/8	G3/8
Pneumatic spring connection	12/14, 10						
	G1/8						

Technical data – 3/2-way valves					
Order code for valves	M32C	M32U	T32C	T32U	T32H
Normal position	Closed	Open	Closed	Open	1x open, 1x closed
Stable position	Monostable				
Reset method	Mechanical spring				
Switching times in [ms]	On	11	12	12	12
	Off	37	45	37	45

Pneumatic valves VUWS-LT, size 30

Technical data

Technical data – 5/2-way valves			
Order code for valves	M52	B52	
Stable position	Monostable	Bistable	
Reset method	Mechanical spring	–	
Switching times in [ms]	On	17	–
	Off	77	–
	Change-over	–	13

Safety characteristics	
Shock resistance	Shock test with severity level 2 to FN 942017-5 and EN 60068-2-27
Vibration resistance	Transport application test with severity level 2 to FN 942017-4 and EN 60068-2-6

Operating and environmental conditions				
Order code for valves	M32	T32	M52	B52
Operating medium	Compressed air to ISO 8573-1:2010 [7:4:4]			
Pilot medium	Compressed air to ISO 8573-1:2010 [7:4:4]			
Note on the operating/pilot medium	Lubricated operation possible (in which case lubricated operation will always be required)			
Operating pressure [bar]	1 ... 10	1 ... 10	2.5 ... 10	1.5 ... 10
Pilot pressure [bar]	2.5 ... 10	2.5 ... 10	2.5 ... 10	1.5 ... 10
Ambient temperature [°C]	–10 ... +60			
Temperature of medium [°C]	–10 ... +60			
Approval certificate	c UL us - Recognized (OL)			
Corrosion resistance class CRC ¹⁾	2			

1) Corrosion resistance class CRC 2 to Festo standard FN 940070
Moderate corrosion stress. Indoor applications in which condensation may occur. External visible parts with primarily decorative requirements for the surface and which are in direct contact with the ambient atmosphere typical for industrial applications.

Information on materials				
Order code for valves	M32	T32	M52	B52
Housing	Die-cast aluminium (painted)			
Piston slide	POM		Wrought aluminium alloy	
Seals	HNBR, NBR, TPE-U(PU)			
Screws	Galvanised steel			
Note on materials	RoHS-compliant			

Pneumatic valves VUWS-LT, size 30

Technical data

Dimensions

Download CAD data → www.festo.com

3/2-way valve, normally closed/open

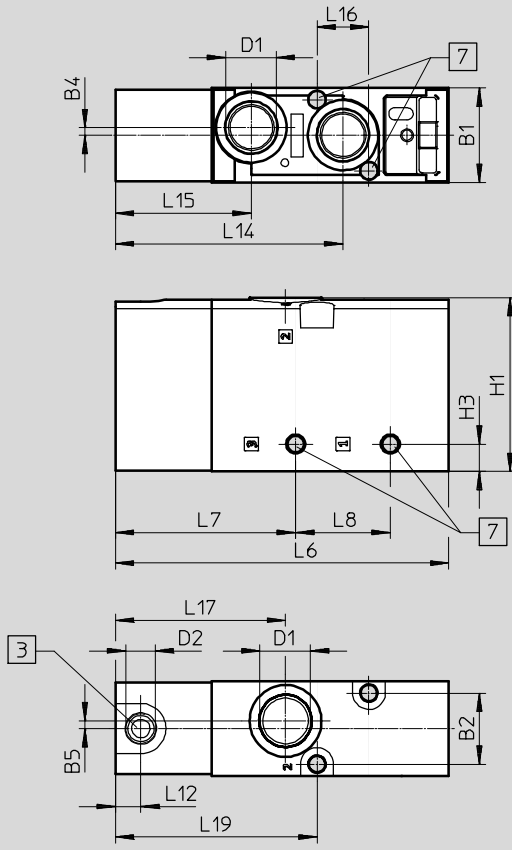

- 3 Connection 10: pilot air (...-M32U-...)
Connection 12: pilot air (...-M32C-...)
- 7 For retaining screw M5

Type	B1	B2	B4	B5	D1	D2	H1	H3
VUWS-LT30-M32...-G38	31	23.3	2.5	2.5	G3/8	G1/8	57	9

Type	L6	L7	L8	L12	L14	L15	L16	L17	L19
VUWS-LT30-M32...-G38	109.2	59	31	8.3	74.5	44.5	17	55.7	66

Pneumatic valves VUWS-LT, size 30

Technical data

Dimensions

Download CAD data → www.festo.com

5/2-way valve, monostable

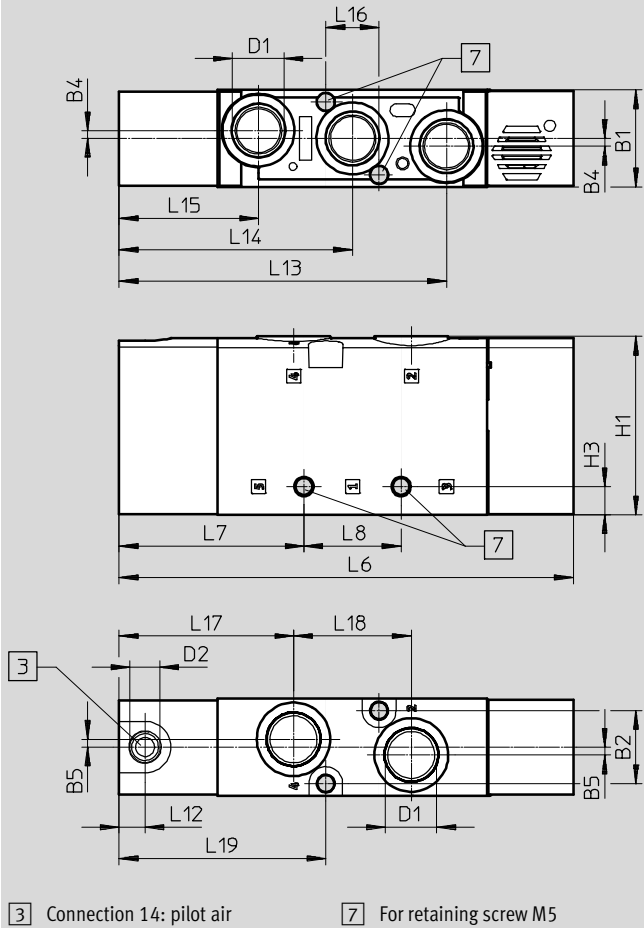

Type	B1	B2	B4	B5	D1	D2	H1	H3
VUWS-LT30-M52-...-G38	31	23.3	2.5	2.5	G3/8	G1/8	57	9

Type	L6	L7	L8	L12	L13	L14	L15	L16	L17	L18	L19
VUWS-LT30-M52-...-G38	145	59	31	8.3	104.5	74.5	44.5	17	55.7	37.6	66

Pneumatic valves VUWS-LT, size 30

Technical data

Dimensions

Download CAD data → www.festo.com

2x 3/2-way valve and 5/2-way valve, bistable

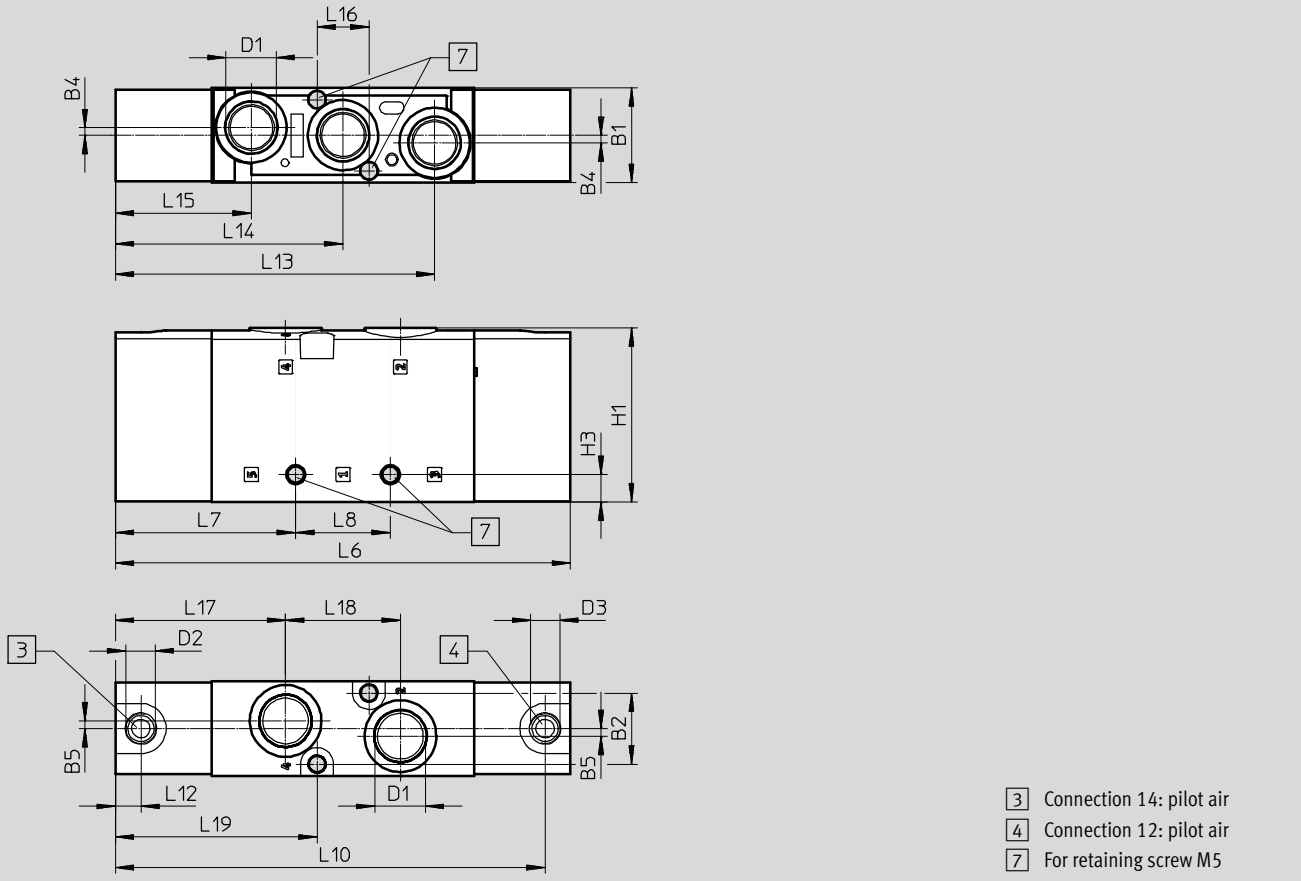

Type	B1	B2	B4	B5	D1	D2	D3	H1	H3
VUWS-LT30-B52-G38	31	23.3	2.5	2.5	G3/8	G1/8	G1/8	57	9
VUWS-LT30-T32-...-M-G38									

Type	L6	L7	L8	L10	L12	L13	L14	L15	L16	L17	L18	L19
VUWS-LT30-B52-G38	149	59	31	140.7	8.3	104.5	74.5	44.5	17	55.7	37.6	66
VUWS-LT30-T32-...-M-G38												

Pneumatic valves VUWS-LT, size 30

Accessories

FESTO

Dimensions

Foot mounting

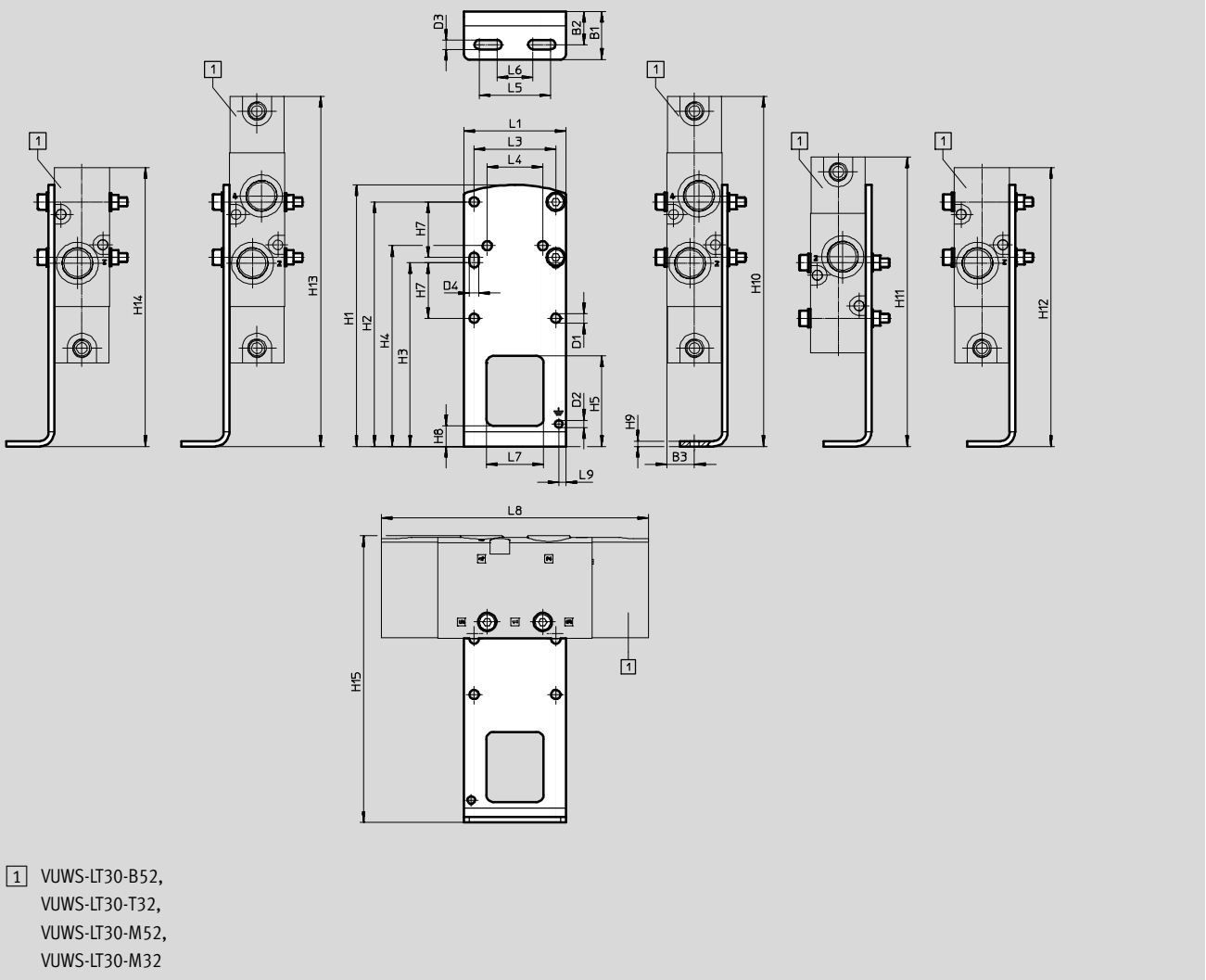

Type		B1	B2	B3	D1 ∅	D2 ∅	D3	D4	H1	H2	H3
VAME-B10-30-A	VUWS-LT30-B52/T32	26.8	18.5	15.5	5.2	4.2	5.2	5.2	146	136.5	102.5
	VUWS-LT30-M52										
	VUWS-LT30-M32										

Type		H4	H5	H7	H8	H9	H10	H11	H12	H13	H14
VAME-B10-30-A	VUWS-LT30-B52/T32	112	50.5	31	11.5	3	195.5	161.5	195.5	195.5	195.5
	VUWS-LT30-M52								191.5		191.5
	VUWS-LT30-M32								144		144

Type		H15	L1	L3	L4	L5	L6	L7	L8	L9
VAME-B10-30-A	VUWS-LT30-B52/T32	160	57	45.6	31	40	20	32	149	4.1
	VUWS-LT30-M52								145	
	VUWS-LT30-M32								97.5	

Pneumatic valves VUWS-LT, size 30

Accessories

Dimensions

Wall mounting

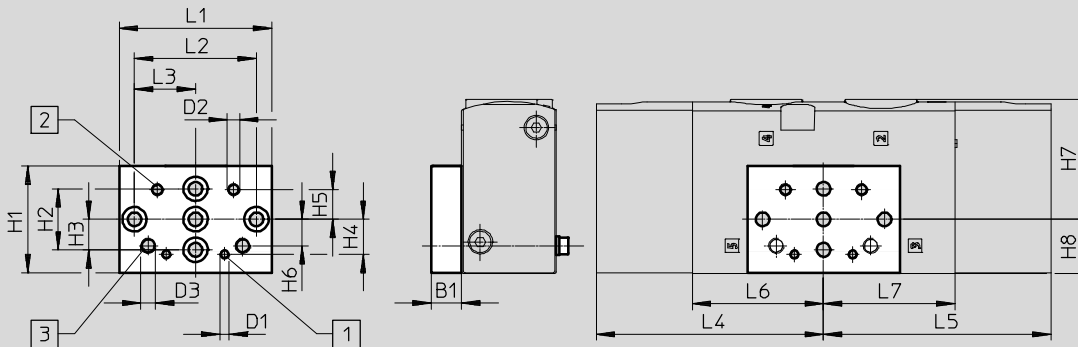

1 Mounting hole for size 20 2 Mounting hole for size 25 3 Mounting hole for size 30

Type		B1	D1	D2	D3	H1	H2	H3	H4	H5	H6
VAME-B10-20-W	VUWS-LT30-B52/T32	10	M3	M4	M5	35	20	10	11.5	9.7	8.7
	VUWS-LT30-M52										
	VUWS-LT30-M32										

Type		H7	H8	L1	L2	L3	L4	L5	L6	L7
VAME-B10-20-W	VUWS-LT30-B52/T32	39.3	17.7	50	40	20	74.5	74.5	43	43
	VUWS-LT30-M52							70.5		-
	VUWS-LT30-M32							23		-



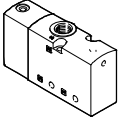
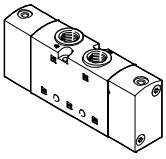
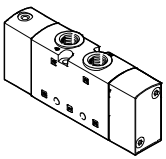
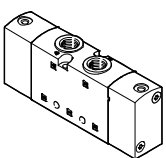

Pneumatic valves VUWS-LT, size 30

Accessories

Ordering data – Pneumatic valves				
	Code	Valve function	Part No.	Type
3/2-way valve				
	Normally closed, monostable			
	M32C-M	Reset via mechanical spring, internal pilot air supply, flow direction not reversible	8096574	VUWS-LT30-M32C-M-G38
	Normally open, monostable			
	M32U-M	Reset via mechanical spring, internal pilot air supply, flow direction not reversible	8096575	VUWS-LT30-M32U-M-G38
2x 3/2-way valve				
	Normally closed, monostable			
	T32C	Reset via mechanical spring, internal pilot air supply, flow direction not reversible	8036706	VUWS-LT30-T32C-M-G38
	Normally open, monostable			
	T32U	Reset via mechanical spring, internal pilot air supply, flow direction not reversible	8036713	VUWS-LT30-T32U-M-G38
1x normally open, 1x normally closed, monostable				
	T32H	Reset via mechanical spring, internal pilot air supply, flow direction not reversible	8036720	VUWS-LT30-T32H-M-G38
5/2-way valve				
	Monostable			
	M52-M	Reset via mechanical spring, internal pilot air supply, flow direction not reversible	8096576	VUWS-LT30-M52-M-G38
	Bistable			
	B52	Internal pilot air supply, flow direction not reversible	8096577	VUWS-LT30-B52-G38

Pneumatic valves VUWS-LT, size 30

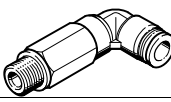
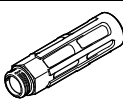

Accessories

Ordering data					
	Description		Part No.	Type	PU ¹⁾
Push-in fitting with internal hexagon					
	Connecting thread G1/8 for tubing O.D.	4 mm	186106	QS-G1/8-4-I	10
			133008	QS-G1/8-4-I-100	100
	Connecting thread G3/8 for tubing O.D.	6 mm	186107	QS-G1/8-6-I	10
			133009	QS-G1/8-6-I-100	100
		8 mm	186111	QS-G3/8-8-I	10
		10 mm	186113	QS-G3/8-10-I	10
12 mm	186114	QS-G3/8-12-I	10		
Angled push-in fitting with external hexagon					
	Connecting thread G3/8 for tubing O.D.	8 mm	186121	QSL-G3/8-8	10
			132055	QSL-G3/8-8-50	50
		10 mm	186123	QSL-G3/8-10	10
			132056	QSL-G3/8-10-20	20
		12 mm	186124	QSL-G3/8-12	10
			132057	QSL-G3/8-12-20	20
Angled push-in fitting, long, with external hexagon					
	Connecting thread G3/8 for tubing O.D.	8 mm	186132	QSL-L-G3/8-8	10
		10 mm	186134	QSL-L-G3/8-10	10
		12 mm	186135	QSL-L-G3/8-12	10
Silencers					
	With connecting thread G, metal design	G3/8	6843	U-3/8-B	1
	With connecting thread G, sintered design, long	G3/8	1205862	AMTE-M-LH-G38	10

1) Packaging unit

Pneumatic valves VUWS-LT, size 30

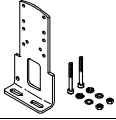
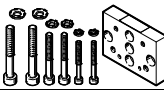
Accessories

Ordering data			
Description	Weight [g]	Part No.	Type
Foot mounting			
	Set for mounting valves, comprising: <ul style="list-style-type: none"> • Mounting bracket and • Screw set for mounting 	–	8026337 VAME-B10-30-A
Wall mounting			
	Set for mounting valves for size 20, 25, 30, comprising: <ul style="list-style-type: none"> • Wall mounting and • Screw set for mounting 	53	576413 VAME-B10-20-W
Assortment of spare parts			
	Set comprising: <ul style="list-style-type: none"> • Seals and • Screws 	–	8035637 VAME-B10-30-MK
Inscription label			
	40 pieces in frame	–	565306 ASLR-C-E4

Pneumatic valves VUWS-L, size 20

Technical data

-  - Flow rate
Up to 700 l/min (±20%)

-  - Valve width
21 mm



General technical data								
Valve function	3/2			5/2		5/3		
Order code for valves	M32C	M32U	M52	B52	P53C	P53U	P53E	
Valve width [mm]	21							
Design	Piston spool							
Pneumatic spring supply	Internal or external (external: identified by E in type code)							
Type of piloting	Direct							
Manual override (MO)	None							
Direction of flow	Reversible with restrictions							
Lap	Overlap							
Sealing principle	Soft							
Type of mounting	Optionally via through-holes ¹⁾ or on manifold rail							
Standard nominal flow rate qnN [l/min]	700		700		700	600	600	
Through-holes (nominal width) [mm]	5.7		5.7		5.0	4.8	4.5	
Product weight [g]	145		178/190 ²⁾	211	207	207	207	
Type of actuation	Pneumatic							
Mounting position	Any							
Exhaust air function	With flow control							
Venting hole	Not ducted							
Pneumatic connection	1, 2, 3	G1/8	G1/8	G1/8	G1/8	G1/8	G1/8	G1/8
	4, 5	-	-	G1/8	G1/8	G1/8	G1/8	G1/8
Pneumatic spring connection 12/14, 10	M5							

1) If several valves are to be screwed together via the through-holes to form a block, a minimum distance of 0.3 mm must be ensured by placing spacer discs between them.

2) With external pneumatic spring: 190 g, with internal pneumatic spring or mechanical spring: 178 g

Pneumatic valves VUWS-L, size 20

Technical data

Technical data – 3/2-way valves					
Order code for valves		M32C		M32U	
Normal position		Closed		Open	
Stable positions		Monostable		Monostable	
Reset method		Pneumatic spring	Mechanical spring (supported internally by pneumatic spring)	Pneumatic spring	Mechanical spring (supported internally by pneumatic spring)
Switching times [ms]	On	7	10	7	10
	Off	15	28	15	28
	Change-over	–	–	–	–

Technical data – 5/2-way valves				
Order code for valves		M52		B52
Stable position		Monostable		Bistable
Reset method		Pneumatic spring	Mechanical spring	–
Switching times [ms]	On	13	7	–
	Off	26	39	–
	Change-over	–	–	6

Technical data – 5/3-way valves					
Order code for valves		P53C		P53U	P53E
Stable position		Monostable			
Reset method		Mechanical spring			
Switching times [ms]	On	10	10	10	
	Off	44	43	46	
	Change-over	26	21	21	

Safety characteristics	
Resistance to shocks	Shock test with severity level 2 to FN 942017-5 and EN 60068-2-27
Vibration resistance	Transport application test with severity level 2 to FN 942017-4 and EN 60068-2-6

Operating and environmental conditions							
Valve function		M32 ... A M32 ... M	M32C-E M32U-E	M52-A	M52-E M52-M	B52	P53
Operating medium		Compressed air to ISO 8573-1:2010 [7:4:4]					
Pilot medium		Compressed air to ISO 8573-1:2010 [7:4:4]					
Note on operating/pilot medium		Lubricated operation possible (in which case lubricated operation will always be required)					
Operating pressure	[bar]	2.5 ... 10	–0.9 ... +10	2.5 ... 10	–0.9 ... +10	–0.9 ... +10	–0.9 ... +10
Pilot pressure	[bar]	2.5 ... 10	2.5 ... 10	2.5 ... 10	2.5 ... 10	1.5 ... 10	2.5 ... 10
Ambient temperature	[°C]	–10 ... +60					
Temperature of medium	[°C]	–10 ... +60					
Certification		c UL us - Recognized (OL)					
Corrosion resistance class CRC ¹⁾		2					

1) Corrosion resistance class CRC 2 to Festo standard FN 940070
Moderate corrosion stress. Indoor applications in which condensation may occur. External visible parts with primarily decorative requirements for the surface and which are in direct contact with the ambient atmosphere typical for industrial applications.

Pneumatic valves VUWS-L, size 20

Technical data

Information on materials	
Housing	Die-cast aluminium (painted)
Seals	HNBR, NBR
Piston spool	Wrought aluminium alloy (P53 types: high-alloy stainless steel)
Screws	Galvanised steel
Note on materials	RoHS compliant

Special features of pneumatic 3/2-way valves

Reset: mechanical spring

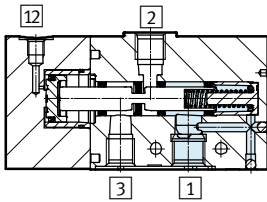

- Internal pneumatic spring
- Faster switch-off time
 - In the case of dual-pressure operation, the higher pressure must always be present at port 1
 - Pressure on port 2 not permitted

Reset: pneumatic spring

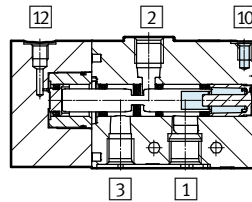

- External pneumatic spring
- Can be used as a bistable valve
 - Signal pressure depends on the pressure of the pneumatic spring
 - No impairment of the switching function caused by vacuum
 - Pressure is permitted on port 2

Pneumatic valves VUWS-L, size 20

Technical data

Dimensions

Download CAD data → www.festo.com

3/2-way valve, normally closed/open

3/2-way valve, normally closed/open, external pilot air

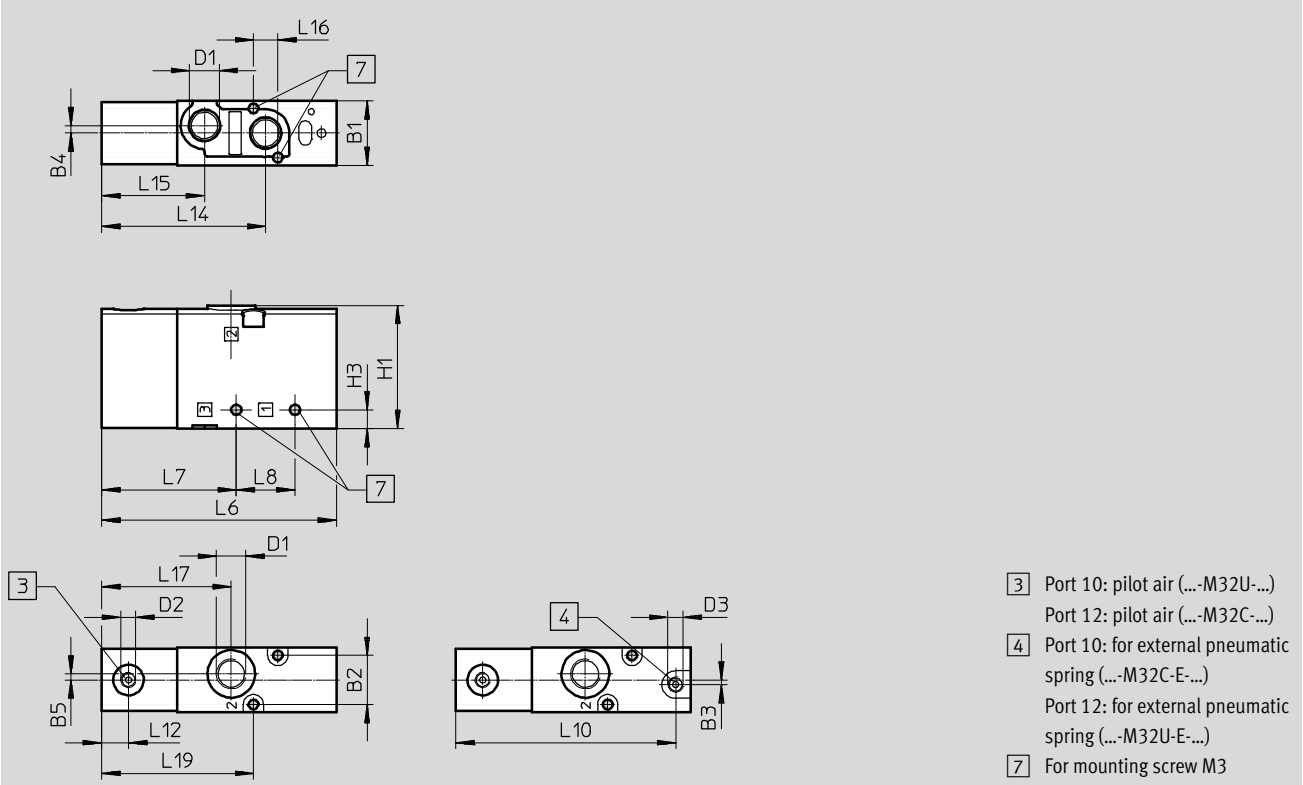

- 3 Port 10: pilot air (...-M32U-...)
Port 12: pilot air (...-M32C-...)
- 4 Port 10: for external pneumatic spring (...-M32C-E-...)
Port 12: for external pneumatic spring (...-M32U-E-...)
- 7 For mounting screw M3

Type	B1	B2	B3	B4	B5	D1	D2	D3	H1	H3
VUWS-L20-M32C-...-G18	21.1	16.1	-	2.5	2	G1/8	M5	-	40.4	6.2
VUWS-L20-M32U-...-G18			-					-		
VUWS-L20-M32C-E-...-G18			1.5					M5		
VUWS-L20-M32U-E-...-G18			1.5					M5		

Type	L6	L7	L8	L10	L12	L14	L15	L16	L17	L19
VUWS-L20-M32C-...-G18	77	44.1	19.2	-	8.8	53.7	33.7	8	42.5	49.7
VUWS-L20-M32U-...-G18				-						
VUWS-L20-M32C-E-...-G18				72						
VUWS-L20-M32U-E-...-G18				72						

Pneumatic valves VUWS-L, size 20

Technical data

Dimensions Download CAD data → www.festo.com

5/2-way valve, monostable, external pilot air 5/2-way valve, monostable

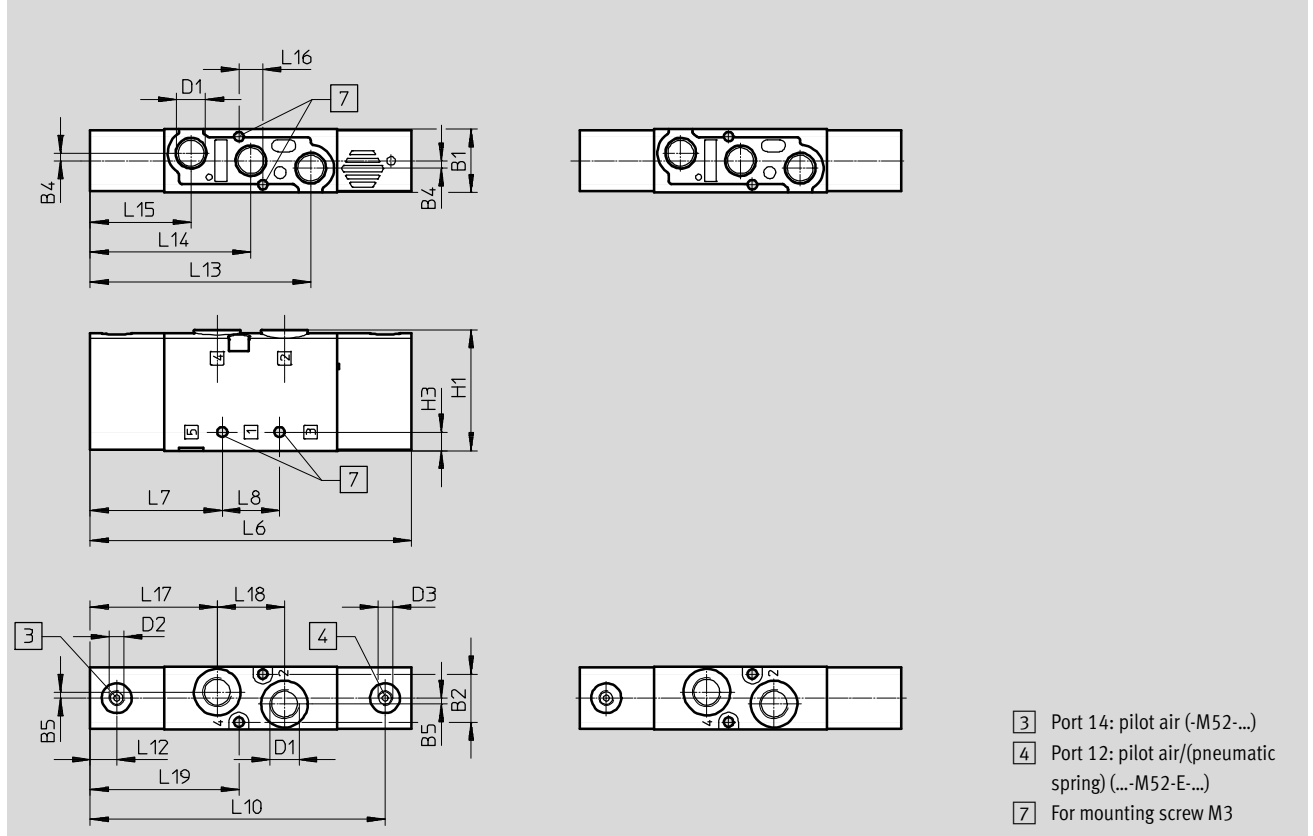

Type	B1	B2	B4	B5	D1	D2	D3	H1	H3
VUWS-L20-M52-...-G18	21.1	16.1	2.5	2	G1/8	M5	-	40.4	6.2
VUWS-L20-M52-E-G18					G1/8	M5	M5		

Type	L6	L7	L8	L10	L12	L13	L14	L15	L16	L17	L18	L19
VUWS-L20-M52-...-G18	107.4	44.1	19.2	-	8.8	73.7	53.7	33.7	8	42.5	22.5	49.7
VUWS-L20-M52-E-G18				98.6								

Pneumatic valves VUWS-L, size 20

Technical data

Dimensions

Download CAD data → www.festo.com

5/2-way valve, bistable, 5/3-way valve

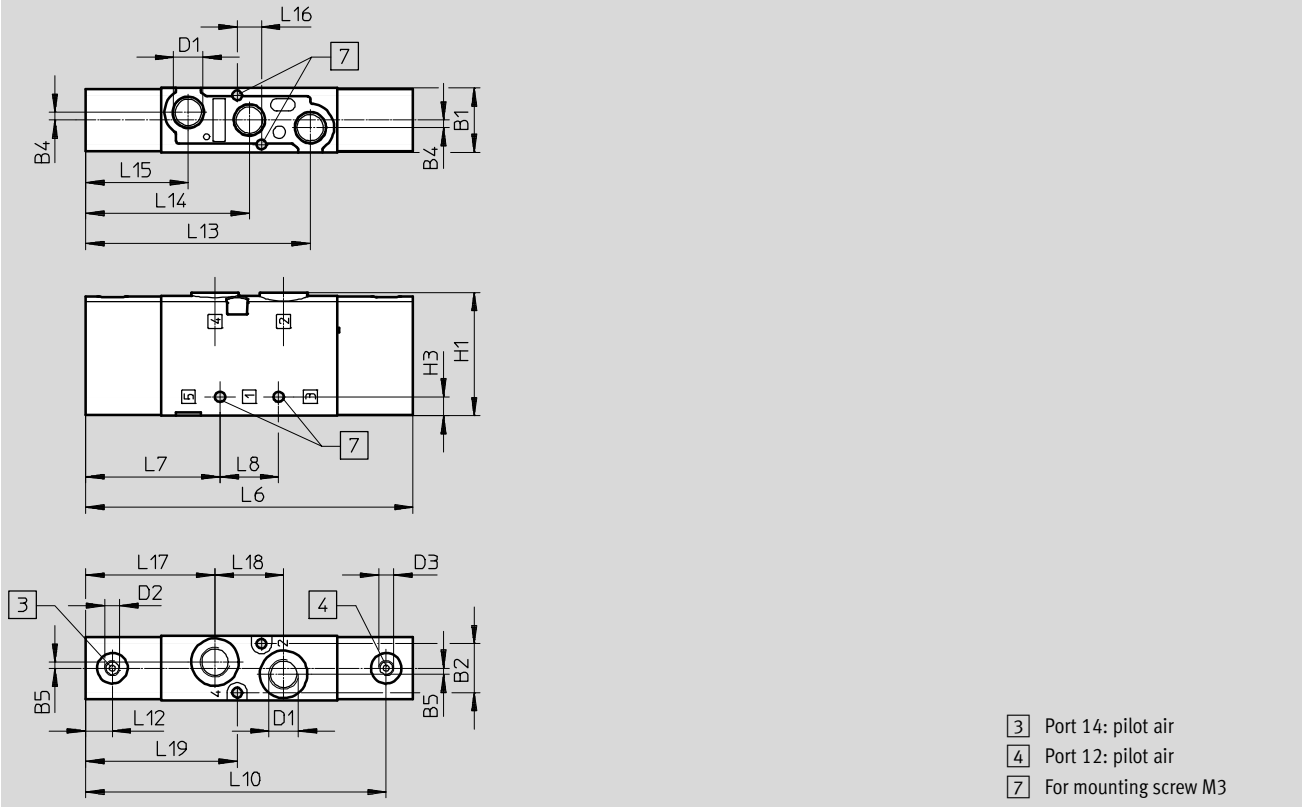

Type	B1	B2	B4	B5	D1	D2	D3	H1	H3
VUWS-L20-P53-...-M-G18	21.1	16.1	2.5	2	G1/8	M5	M5	40.4	6.2
VUWS-L20-B52-G18									

Type	L6	L7	L8	L10	L12	L13	L14	L15	L16	L17	L18	L19
VUWS-L20-P53-...-M-G18	107.4	44.1	19.2	98.6	8.8	73.7	53.7	33.7	8	42.5	22.5	49.7
VUWS-L20-B52-G18												

Pneumatic valves VUWS-L, size 20

Technical data

Dimensions

Foot mounting

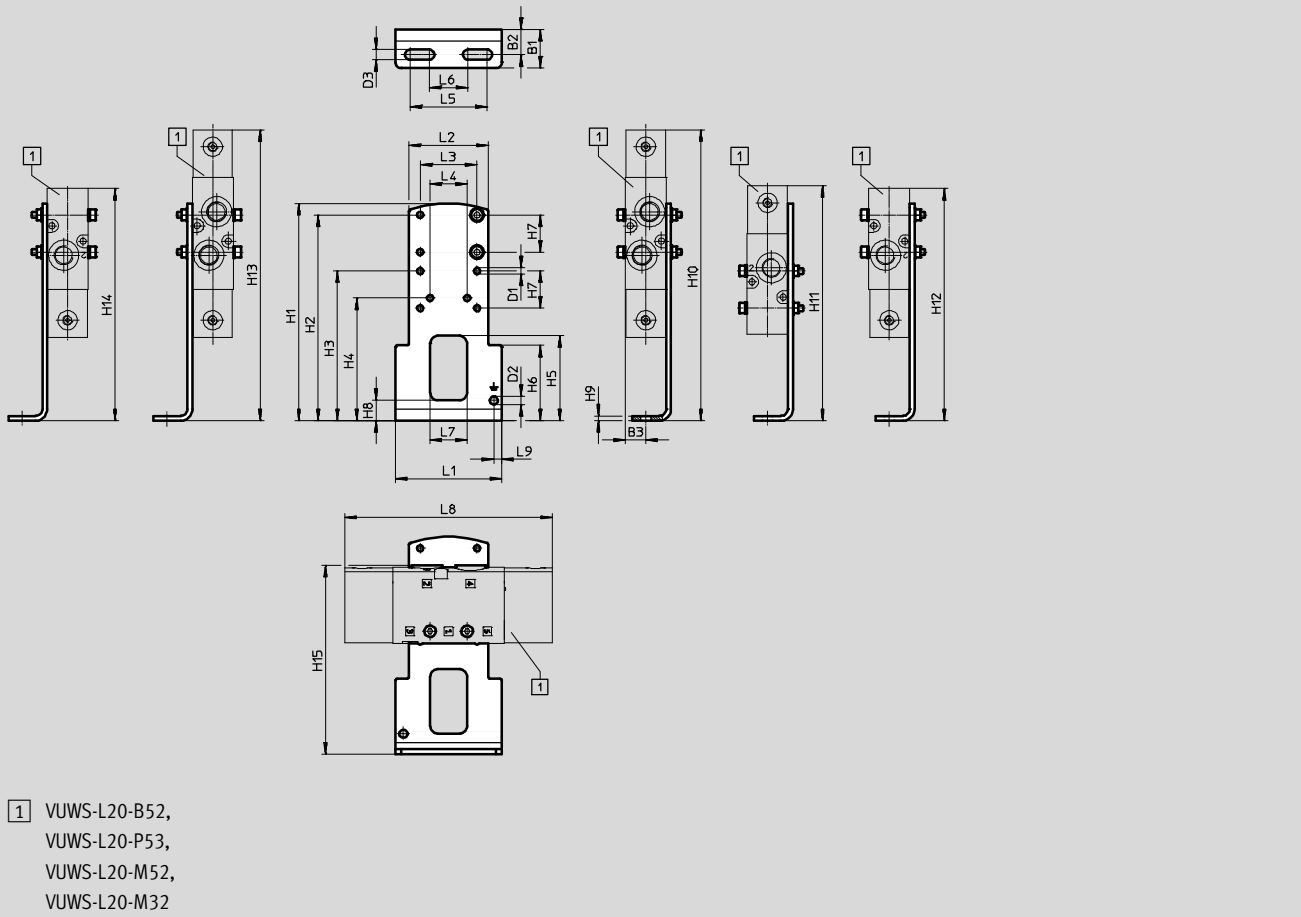

Type		B1	B2	B3	D1 Ø	D2 Ø	D3 Ø	H1	H2	H3	H4
VAME-B10-20-A	VUWS-L20-B52/P53	20	13.1	10.6	3.2	4.2	5.2	112.5	106.5	77.5	63.5
	VUWS-L20-M52										
	VUWS-L20-M32										

Type		H5	H6	H7	H8	H9	H10	H11	H12	H13	H14
VAME-B10-20-A	VUWS-L20-B52/P53	44	39	19.2	10.5	2.5	150.6	121.6	150.6	150.6	150.6
	VUWS-L20-M52										
	VUWS-L20-M32								120.2		120.2

Type		H15	L1	L2	L3	L4	L5	L6	L7	L8	L9
VAME-B10-20-A	VUWS-L20-B52/P53	97.7	55	41	29.4	19.2	40	20	19	107.4	4.1
	VUWS-L20-M52										
	VUWS-L20-M32									77	

Pneumatic valves VUWS-L, size 20

Technical data

Dimensions

Wall mounting

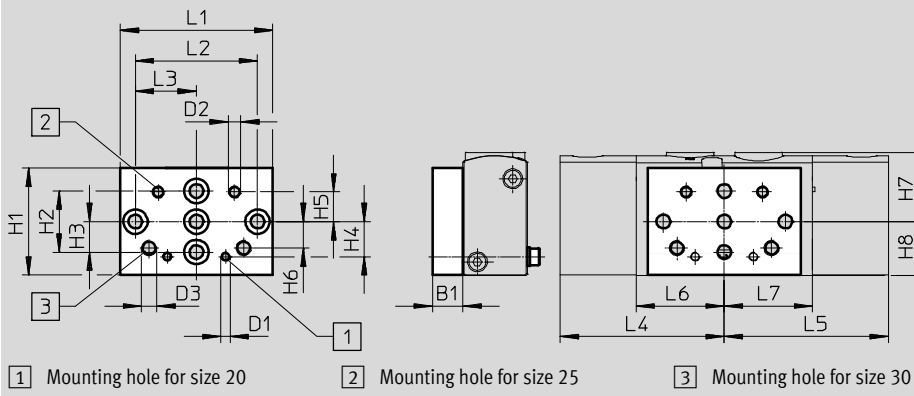

Type		B1	D1	D2	D3	H1	H2	H3	H4	H5	H6
VAME-B10-20-W	VUWS-L20-B52/P53	10	M3	M4	M5	35	20	10	11.5	9.7	8.7
	VUWS-L20-M52										
	VUWS-L20-M32										

Type		H7	H8	L1	L2	L3	L4	L5	L6	L7
VAME-B10-20-W	VUWS-L20-B52/P53	22.7	17.7	50	40	20	53.7	53.7	28.9	28.9
	VUWS-L20-M52									
	VUWS-L20-M32									



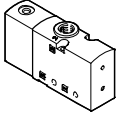
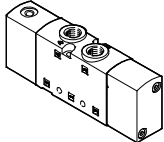
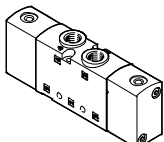

Pneumatic valves VUWS-L, size 20

Ordering data

Ordering data – Pneumatic valves				
	Code	Valve function	Part No.	Type
3/2-way valve				
	Normally closed, monostable			
	M32C-A	Pneumatic spring return, internal pneumatic spring, direction of flow not reversible	575669	VUWS-L20-M32C-A-G18
	M32C-E	Pneumatic spring return, external pneumatic spring, direction of flow reversible	575670	VUWS-L20-M32C-E-G18
	M32C-M	Mechanical spring return, supported by internal pneumatic spring, direction of flow not reversible	575671	VUWS-L20-M32C-M-G18
	Normally open, monostable			
	M32U-A	Pneumatic spring return, internal pneumatic spring, direction of flow not reversible	575672	VUWS-L20-M32U-A-G18
	M32U-E	Pneumatic spring return, external pneumatic spring, direction of flow reversible	575673	VUWS-L20-M32U-E-G18
	M32U-M	Mechanical spring return, supported by internal pneumatic spring, direction of flow not reversible	575674	VUWS-L20-M32U-M-G18
	5/2-way valve			
	Monostable			
	M52-A	Pneumatic spring return, internal pneumatic spring, direction of flow not reversible	575677	VUWS-L20-M52-A-G18
	M52-E	Pneumatic spring return, external pneumatic spring, direction of flow reversible	575678	VUWS-L20-M52-E-G18
	M52-M	Mechanical spring return, direction of flow reversible	575681	VUWS-L20-M52-M-G18
	Bistable			
	B52	Direction of flow reversible	575684	VUWS-L20-B52-G18
5/3-way valve				
	P53C	Closed, mechanical spring return, direction of flow reversible	575687	VUWS-L20-P53C-M-G18
	P53E	Exhausted, mechanical spring return, direction of flow reversible	575693	VUWS-L20-P53E-M-G18
	P53U	Pressurised, mechanical spring return, direction of flow reversible	575690	VUWS-L20-P53U-M-G18

Pneumatic valves VUWS-L, size 20

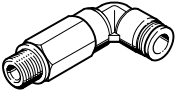
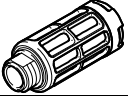
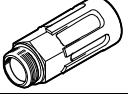

Accessories

Ordering data					
	Description		Part No.	Type	PU ¹⁾
Push-in fitting with internal hex					
	Connecting thread M5 for tubing O.D.	4 mm	153315	QSM-M5-4-I	10
	Connecting thread G1/8 for tubing O.D.	4 mm	186106	QS-G1/8-4-I	10
		4 mm	133008	QS-G1/8-4-I-100	100
		6 mm	186107	QS-G1/8-6-I	10
			133009	QS-G1/8-6-I-100	100
		8 mm	186109	QS-G1/8-8-I	10
			133010	QS-G1/8-8-I-100	100
Angled push-in fitting with external hex					
	Connecting thread G1/8 for tubing O.D.	4 mm	186116	QSL-G1/8-4	10
			132048	QSL-G1/8-4-100	100
		6 mm	186117	QSL-G1/8-6	10
			132049	QSL-G1/8-6-100	100
		8 mm	186119	QSL-G1/8-8	10
			132050	QSL-G1/8-8-50	50
Angled push-in fitting, long, with external hex					
	Connecting thread G1/8 for tubing O.D.	4 mm	186127	QSL-G1/8-4	10
			133015	QSL-G1/8-4-100	100
		6 mm	186128	QSL-G1/8-6	10
			133016	QSL-G1/8-6-100	100
		8 mm	186130	QSL-G1/8-8	10
			133017	QSL-G1/8-8-100	100
Silencers					
	With connecting thread G, polymer design	G1/8	2307	U-1/8	1
			534222	U-1/8-50	50
	With connecting thread G, metal design	G1/8	6841	U-1/8-B	1
	With connecting thread G, sintered design, long	G1/8	1205860	AMTE-M-LH-G18	20

1) Packaging unit

Pneumatic valves VUWS-L, size 20

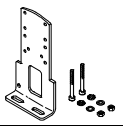
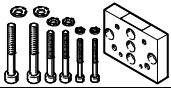
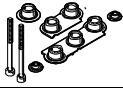
Accessories

Ordering data			
Description	Weight [g]	Part No.	Type
Foot mounting			
	Set for mounting valves, comprising: <ul style="list-style-type: none"> • Mounting bracket and • Screw set for mounting 	97	576412 VAME-B10-20-A
Wall mounting			
	Set for mounting valves for size 20, 25, 30, comprising: <ul style="list-style-type: none"> • Wall mounting and • Screw set for mounting 	53	576413 VAME-B10-20-W
Assortment of spare parts			
	Set comprising: <ul style="list-style-type: none"> • Seals and • Screws 	10	8026203 VAME-B10-20-MK
Inscription label			
	40 pieces in frame	-	565306 ASLR-C-E4

Pneumatic valves VUWS-L, size 25

Technical data

-  - Flow rate
Up to 1300 l/min (±20%)

-  - Valve width
26.5 mm



General technical data							
Valve function	3/2		5/2		5/3		
Order code for valves	M32C	M32U	M52	B52	P53C	P53U	P53E
Valve width [mm]	26.5						
Design	Piston spool						
Pneumatic spring supply	Internal or external (external: identified by E in type code)						
Type of pilot control	Direct						
Manual override (MO)	None						
Direction of flow	Reversible with restrictions (not reversible: identified by A in type code)						
Lap	Overlap						
Sealing principle	Soft						
Type of mounting	Optionally via through-holes ¹⁾ or on manifold rail						
Standard nominal flow rate qnN [l/min]	1000	1000	1300	1300	1200	1000	1000
Through-holes (nominal width) [mm]	6.3	6.3	6.9	6.9	6.5	6.3	6.3
Product weight [g]	268	268	330/360 ²⁾	363	364	364	364
Type of actuation	Pneumatic						
Mounting position	Any						
Exhaust air function	With flow control						
Venting hole	Not ducted						
Pneumatic connection	1, 2, 3	G1/4	G1/4	G1/4	G1/4	G1/4	G1/4
	4, 5	-	-	G1/4	G1/4	G1/4	G1/4
Pneumatic spring connection	12/14, 10	M5					

1) If several valves are to be screwed together via the through-holes to form a block, a minimum distance of 0.3 mm must be ensured by placing spacer discs between them.

2) With external pneumatic spring: 360 g, with internal pneumatic spring or mechanical spring: 330 g

Technical data – 3/2-way valves					
Order code for valves	M32C			M32U	
Normal position	Closed			Open	
Stable positions	Monostable			Monostable	
Reset method	Pneumatic spring		Mechanical spring		
Switching times [ms]	On	10	10	10	10
	Off	25	43	25	43
	Change-over	-	-	-	-

Pneumatic valves VUWS-L, size 25

Technical data

Technical data – 5/2-way valves			
Order code for valves		M52	B52
Stable position		Monostable	Bistable
Reset method		Pneumatic spring	Mechanical spring
Switching times [ms]	On	15	10
	Off	32	42
	Change-over	–	–
			10

Technical data – 5/3-way valves				
Order code for valves		P53C	P53U	P53E
Stable position		Monostable		
Reset method		Mechanical spring		
Switching times [ms]	On	13	13	13
	Off	65	65	65
	Change-over	30	30	30

Safety characteristics	
Resistance to shocks	Shock test with severity level 2 to FN 942017-5 and EN 60068-2-27
Vibration resistance	Transport application test with severity level 2 to FN 942017-4 and EN 60068-2-6

Operating and environmental conditions						
Valve function	M32 ... A	M32 ... E M32 ... M	M52-A	M52-E M52-M	B52	P53
Operating medium	Compressed air to ISO 8573-1:2010 [7:4:4]					
Pilot medium	Compressed air to ISO 8573-1:2010 [7:4:4]					
Note on operating/pilot medium	Lubricated operation possible (in which case lubricated operation will always be required)					
Operating pressure [bar]	2.5 ... 10	–0.9 ... +10	2.5 ... 10	–0.9 ... +10	–0.9 ... +10	–0.9 ... +10
Pilot pressure [bar]	2.5 ... 10	2.5 ... 10	2.5 ... 10	2.5 ... 10	1.5 ... 10	2.5 ... 10
Ambient temperature [°C]	–10 ... +60					
Temperature of medium [°C]	–10 ... +60					
Certification	c UL us - Recognized (OL)					
Corrosion resistance class CRC ¹⁾	2					

- 1) Corrosion resistance class CRC 2 to Festo standard FN 940070
Moderate corrosion stress. Indoor applications in which condensation may occur. External visible parts with primarily decorative requirements for the surface and which are in direct contact with the ambient atmosphere typical for industrial applications.

Information on materials	
Housing	Die-cast aluminium (painted)
Seals	HNBR, NBR
Piston spool	Wrought aluminium alloy
Screws	Galvanised steel
Note on materials	RoHS compliant

Pneumatic valves VUWS-L, size 25

Technical data

Dimensions

Download CAD data → www.festo.com

3/2-way valve, normally closed/open

3/2-way valve, normally closed/open, external pilot air

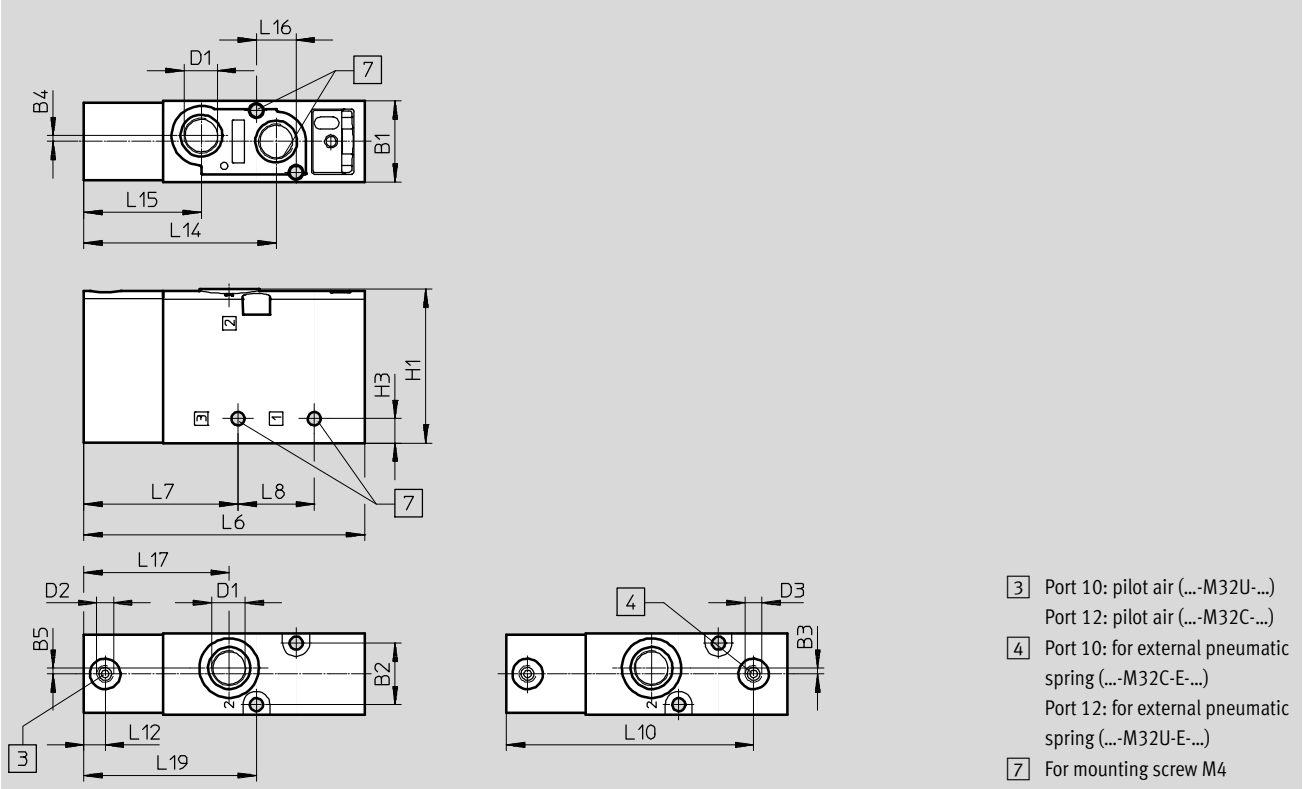

- 3 Port 10: pilot air (...-M32U-...)
Port 12: pilot air (...-M32C-...)
- 4 Port 10: for external pneumatic spring (...-M32C-E-...)
Port 12: for external pneumatic spring (...-M32U-E-...)
- 7 For mounting screw M4

Type	B1	B2	B3	B4	B5	D1	D2	D3	H1	H3
VUWS-L25-M32C-...-G14	26.5	20.2	1.9	1.9	1.9	G1/4	M5	-	50.5	8
VUWS-L25-M32U-...-G14								-		
VUWS-L25-M32C-E-...-G14								M5		
VUWS-L25-M32U-E-...-G14								M5		

Type	L6	L7	L8	L10	L12	L14	L15	L16	L17	L19
VUWS-L25-M32C-...-G14	92	50.5	25	-	7	63	38.5	13	47.6	56.5
VUWS-L25-M32U-...-G14				-						
VUWS-L25-M32C-E-...-G14				81						
VUWS-L25-M32U-E-...-G14				81						

Pneumatic valves VUWS-L, size 25

Technical data

Dimensions

Download CAD data → www.festo.com

5/2-way valve, monostable

5/2-way valve, monostable, external pilot air

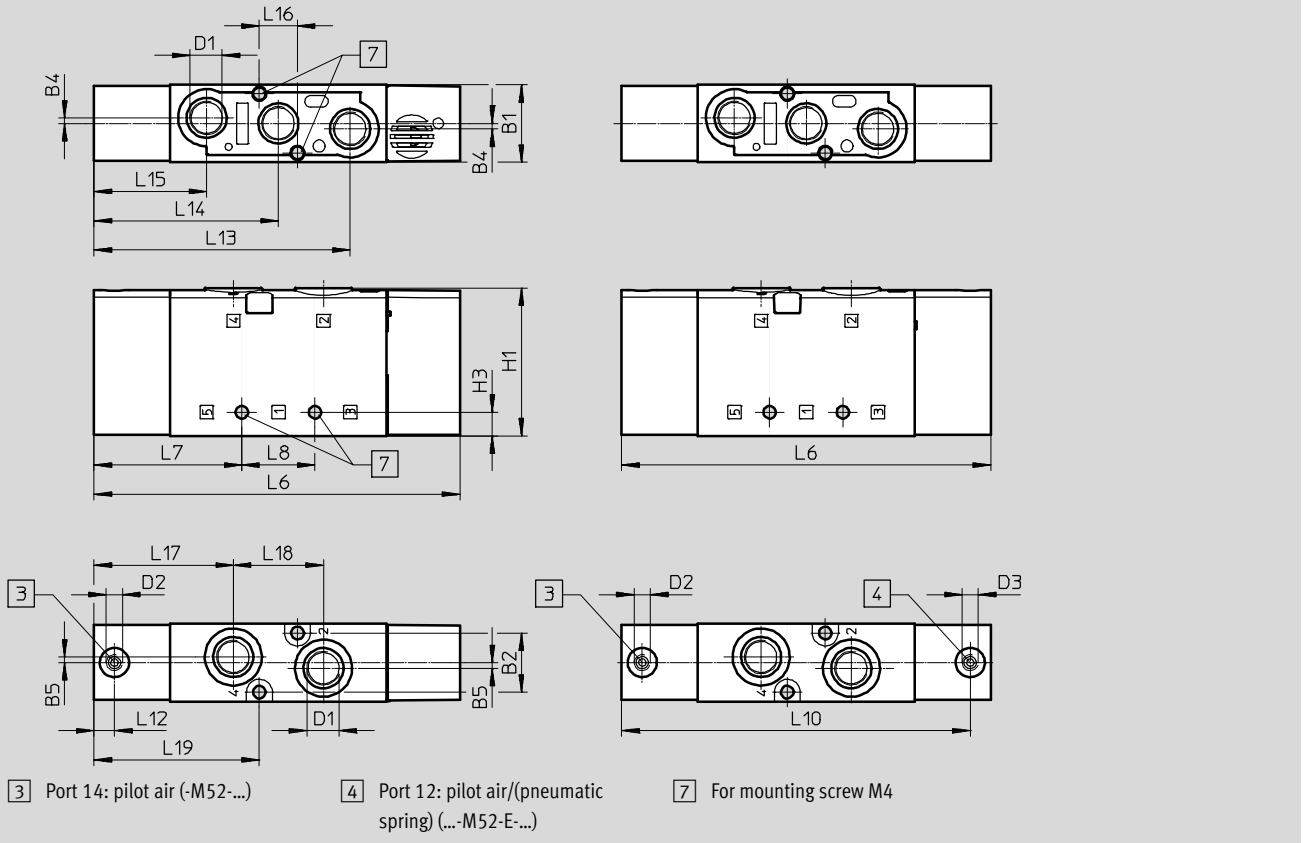

Type	B1	B2	B4	B5	D1	D2	D3	H1	H3
VUWS-L25-M52-...-G14	26.5	20.2	1.9	1.9	G1/4	M5	-	50.5	8
VUWS-L25-M52-E-G14							M5		

Type	L6	L7	L8	L10	L12	L13	L14	L15	L16	L17	L18	L19
VUWS-L25-M52-...-G14	125	50.5	25	-	7	87.5	63	38.5	13	47.6	30.8	56.5
VUWS-L25-M52-E-G14				119								

Pneumatic valves VUWS-L, size 25

Technical data

Dimensions

Download CAD data → www.festo.com

5/2-way valve, bistable, 5/3-way valve

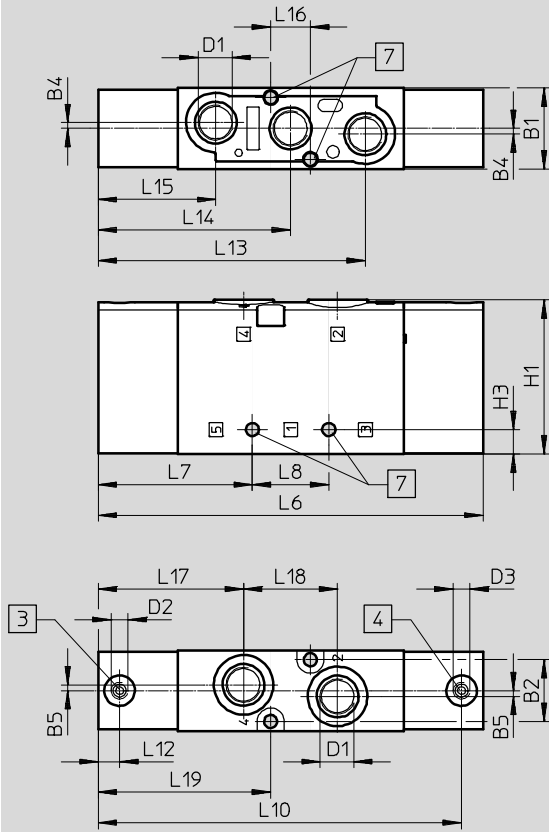

- 3 Port 14: pilot air
- 4 Port 12: pilot air
- 7 For mounting screw M4

Type	B1	B2	B4	B5	D1	D2	D3	H1	H3
VUWS-L25-P53-...-M-G14	26.5	20.2	1.9	1.9	G1/4	M5	M5	50.5	8
VUWS-L25-B52-G14									

Type	L6	L7	L8	L10	L12	L13	L14	L15	L16	L17	L18	L19
VUWS-L25-P53-...-M-G14	126	50.5	25	119	7	87.5	63	38.5	13	47.6	30.8	56.5
VUWS-L25-B52-G14												

Pneumatic valves VUWS-L, size 25

Technical data

Dimensions

Foot mounting

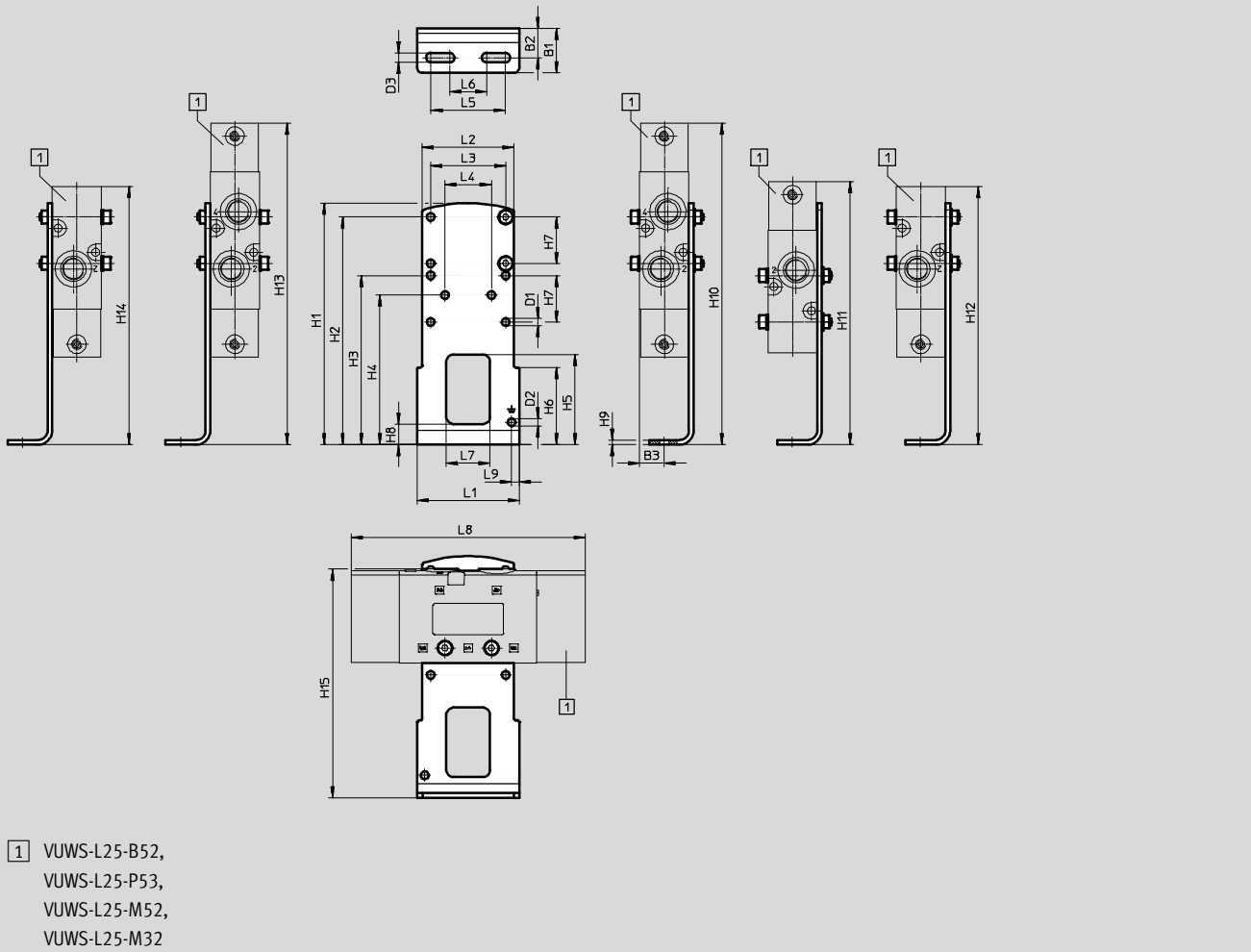

Type		B1	B2	B3	D1 ∅	D2 ∅	D3	H1	H2	H3	H4
VAME-B10-25-A	VUWS-L25-B52/P53	24	15.8	13.3	4.2	4.2	5.2	130	122.5	91	80.5
	VUWS-L25-M52-E										
	VUWS-L25-M52										
	VUWS-L25-M32										

Type		H5	H6	H7	H8	H9	H10	H11	H12	H13	H14	
VAME-B10-25-A	VUWS-L25-B52/P53	48.5	41.5	25	11	2.5	173	141.5	173	173	173	
	VUWS-L25-M52-E											
	VUWS-L25-M52								172			172
	VUWS-L25-M32								139			139

Type		H15	L1	L2	L3	L4	L5	L6	L7	L8	L9	
VAME-B10-25-A	VUWS-L25-B52/P53	123	55	49.4	40.4	25	40	20	23.5	126	4.1	
	VUWS-L25-M52-E											
	VUWS-L25-M52									125		
	VUWS-L25-M32									92		

Pneumatic valves VUWS-L, size 25

Technical data

Dimensions

Wall mounting

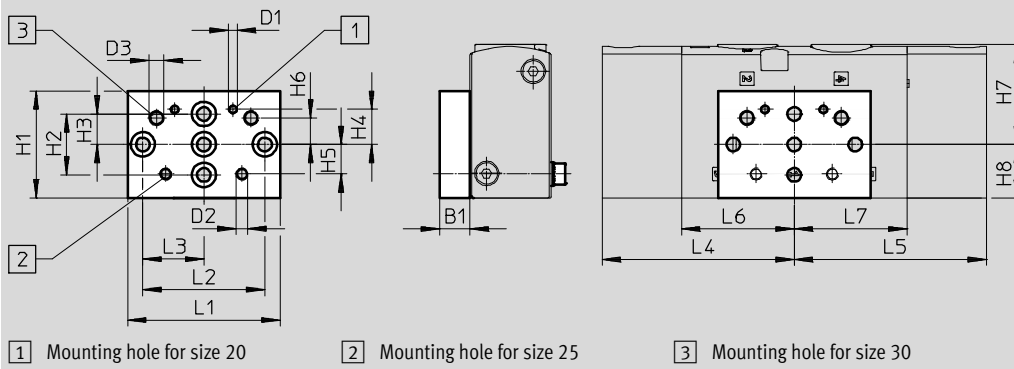

Type		B1	D1	D2	D3	H1	H2	H3	H4	H5	H6
VAME-B10-20-W	VUWS-L25-B52/P53	10	M3	M4	M5	35	20	10	11.5	9.7	8.7
	VUWS-L25-M52-E										
	VUWS-L25-M52										
	VUWS-L25-M32										

Type		H7	H8	L1	L2	L3	L4	L5	L6	L7		
VAME-B10-20-W	VUWS-L25-B52/P53	32.8	17.7	50	40	20	63	63	37	37		
	VUWS-L25-M52-E											
	VUWS-L25-M52										62	-
	VUWS-L25-M32										29	-



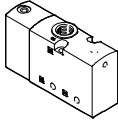
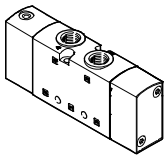
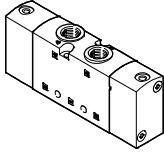

Pneumatic valves VUWS-L, size 25

Ordering data

Ordering data – Pneumatic valves				
	Code	Valve function	Part No.	Type
3/2-way valve				
	Normally closed, monostable			
	M32C-A	Pneumatic spring return, internal pneumatic spring, direction of flow not reversible	575483	VUWS-L25-M32C-A-G14
	M32C-E	Pneumatic spring return, external pneumatic spring, direction of flow reversible	575484	VUWS-L25-M32C-E-G14
	M32C-M	Mechanical spring return, direction of flow reversible	575485	VUWS-L25-M32C-M-G14
	Normally open, monostable			
	M32U-A	Pneumatic spring return, internal pneumatic spring, direction of flow not reversible	575498	VUWS-L25-M32U-A-G14
	M32U-E	Pneumatic spring return, external pneumatic spring, direction of flow reversible	575499	VUWS-L25-M32U-E-G14
M32U-M	Mechanical spring return, direction of flow reversible	575500	VUWS-L25-M32U-M-G14	
5/2-way valve				
	Monostable			
	M52-A	Pneumatic spring return, internal pneumatic spring, direction of flow not reversible	575507	VUWS-L25-M52-A-G14
	M52-E	Pneumatic spring return, external pneumatic spring, direction of flow reversible	575508	VUWS-L25-M52-E-G14
	M52-M	Mechanical spring return, direction of flow reversible	575515	VUWS-L25-M52-M-G14
	Bistable			
B52	Direction of flow reversible	575522	VUWS-L25-B52-G14	
5/3-way valve				
	P53C	Closed, mechanical spring return, direction of flow reversible	575529	VUWS-L25-P53C-M-G14
	P53E	Exhausted, mechanical spring return, direction of flow reversible	575543	VUWS-L25-P53E-M-G14
	P53U	Pressurised, mechanical spring return, direction of flow reversible	575536	VUWS-L25-P53U-M-G14

Pneumatic valves VUWS-L, size 25

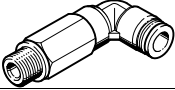
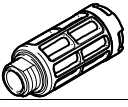
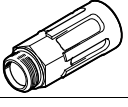

Accessories

Ordering data					
	Description		Part No.	Type	PU ¹⁾
Push-in fitting with internal hex					
	Connecting thread M5 for tubing O.D.	4 mm	153315	QSM-M5-4-I	10
	Connecting thread G1/4 for tubing O.D.	6 mm	186108	QS-G1/4-6-I	10
		8 mm	186110	QS-G1/4-8-I	10
		10 mm	186112	QS-G1/4-10-I	10
Angled push-in fitting with external hex					
	Connecting thread G1/4 for tubing O.D.	6 mm	186118	QSL-G1/4-6	10
			132051	QSL-G1/4-6-100	100
	8 mm	186120	QSL-G1/4-8	10	
		132052	QSL-G1/4-8-50	50	
	10 mm	186122	QSL-G1/4-10	10	
		132053	QSL-G1/4-10-50	50	
Angled push-in fitting, long, with external hex					
	Connecting thread G1/4 for tubing O.D.	6 mm	186129	QSL-L-G1/4-6	10
		8 mm	186131	QSL-L-G1/4-8	10
		10 mm	186133	QSL-L-G1/4-10	10
Silencers					
	With connecting thread G, polymer design	G1/4	2316	U-1/4	1
			534223	U-1/4-20	20
	With connecting thread G, metal design	G1/4	6842	U-1/4-B	1
	With connecting thread G, sintered design, long	G1/4	1205861	AMTE-M-LH-G14	20

1) Packaging unit

Pneumatic valves VUWS-L, size 25

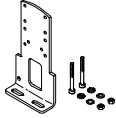
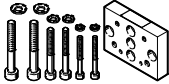
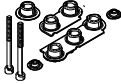
Accessories

Ordering data			
Description	Weight [g]	Part No.	Type
Foot mounting			
	Set for mounting valves, comprising: <ul style="list-style-type: none"> • Mounting bracket and • Screw set for mounting 	130	2293485 VAME-B10-25-A
Wall mounting			
	Set for mounting valves for size 20, 25, 30, comprising: <ul style="list-style-type: none"> • Wall mounting and • Screw set for mounting 	53	576413 VAME-B10-20-W
Assortment of spare parts			
	Set comprising: <ul style="list-style-type: none"> • Seals and • Screws 	12	8035636 VAME-B10-25-MK
Inscription label			
	40 pieces in frame	-	565306 ASLR-C-E4

Pneumatic valves VUWS-L, size 30

Technical data

-  - Flow rate
Up to 2300 l/min (±20%)

-  - Valve width
31 mm



General technical data								
Valve function	3/2			5/2		5/3		
Order code for valves	M32C	M32U	M52	B52	P53C	P53U	P53E	
Valve width [mm]	31							
Design	Piston spool							
Pneumatic spring supply	Internal or external (external: identified by E in type code)							
Type of pilot control	Direct							
Manual override (MO)	None							
Direction of flow	Reversible with restrictions (not reversible: identified by A in type code)							
Lap	Overlap							
Sealing principle	Soft							
Type of mounting	Optionally via through-holes ¹⁾ or on manifold rail							
Nominal flow rate qnN [l/min]	2300	2300	2300	2300	2000	1600	1600	
Through-holes (nominal width) [mm]	9.4	9.4	9.4	9.4	8.9	8.1	8.1	
Product weight [g]	394	394	487/546 ²⁾	545	542	542	542	
Type of actuation	Pneumatic							
Mounting position	Any							
Exhaust air function	With flow control							
Venting hole	Not ducted							
Pneumatic connection	1, 2, 3	G3/8	G3/8	G3/8	G3/8	G3/8	G3/8	G3/8
	4, 5	-	-	G3/8	G3/8	G3/8	G3/8	G3/8
Pneumatic spring connection 12/14, 10	G1/8							

1) If several valves are to be screwed together via the through-holes to form a block, a minimum distance of 0.3 mm must be ensured by placing spacer discs between them.

2) With external pneumatic spring: 546 g, with internal pneumatic spring or mechanical spring: 487 g

Technical data – 3/2-way valves							
Order code for valves	M32C-A		M32C-E	M32C-M	M32U-A	M32U-E	M32U-M
Normal position	Closed				Open		
Stable positions	Monostable				Monostable		
Reset method	Pneumatic spring			Mechanical spring	Pneumatic spring		Mechanical spring
Switching times [ms]	On	19	21	16	19	21	16
	Off	36	40	73	37	40	73

Pneumatic valves VUWS-L, size 30

Technical data

Technical data – 5/2-way valves			
Order code for valves		M52	B52
Stable position		Monostable	Bistable
Reset method		Pneumatic spring	Mechanical spring
Switching times [ms]	On	24	17
	Off	59	77
	Change-over	–	–
			13

Technical data – 5/3-way valves				
Order code for valves		P53C	P53U	P53E
Stable position		Monostable		
Reset method		Mechanical spring		
Switching times [ms]	On	19	19	19
	Off	98	98	98
	Change-over	41	41	41

Safety characteristics	
Resistance to shocks	Shock test with severity level 2 to FN 942017-5 and EN 60068-2-27
Vibration resistance	Transport application test with severity level 2 to FN 942017-4 and EN 60068-2-6

Operating and environmental conditions						
Valve function	M32 ... A M32 ... M	M32 ... E	M52-A	M52-E M52-M	B52	P53
Operating medium	Compressed air to ISO 8573-1:2010 [7:4:4]					
Pilot medium	Compressed air to ISO 8573-1:2010 [7:4:4]					
Note on operating/pilot medium	Lubricated operation possible (in which case lubricated operation will always be required)					
Operating pressure [bar]	–0.9 ... +10	–0.9 ... +10	2.5 ... 10	–0.9 ... +10	–0.9 ... +10	–0.9 ... +10
Pilot pressure [bar]	2.5 ... 10	2.5 ... 10	2.5 ... 10	2.5 ... 10	1.5 ... 10	2.5 ... 10
Ambient temperature [°C]	–10 ... +60					
Temperature of medium [°C]	–10 ... +60					
Certification	c UL us - Recognized (OL)					
Corrosion resistance class CRC ¹⁾	2					

- 1) Corrosion resistance class CRC 2 to Festo standard FN 940070
Moderate corrosion stress. Indoor applications in which condensation may occur. External visible parts with primarily decorative requirements for the surface and which are in direct contact with the ambient atmosphere typical for industrial applications.

Information on materials	
Housing	Die-cast aluminium (painted)
Seals	HNBR, NBR
Piston spool	Wrought aluminium alloy
Screws	Galvanised steel
Note on materials	RoHS compliant

Pneumatic valves VUWS-L, size 30

Technical data

Dimensions

Download CAD data → www.festo.com

3/2-way valve, normally closed/open

3/2-way valve, normally closed/open, external pilot air

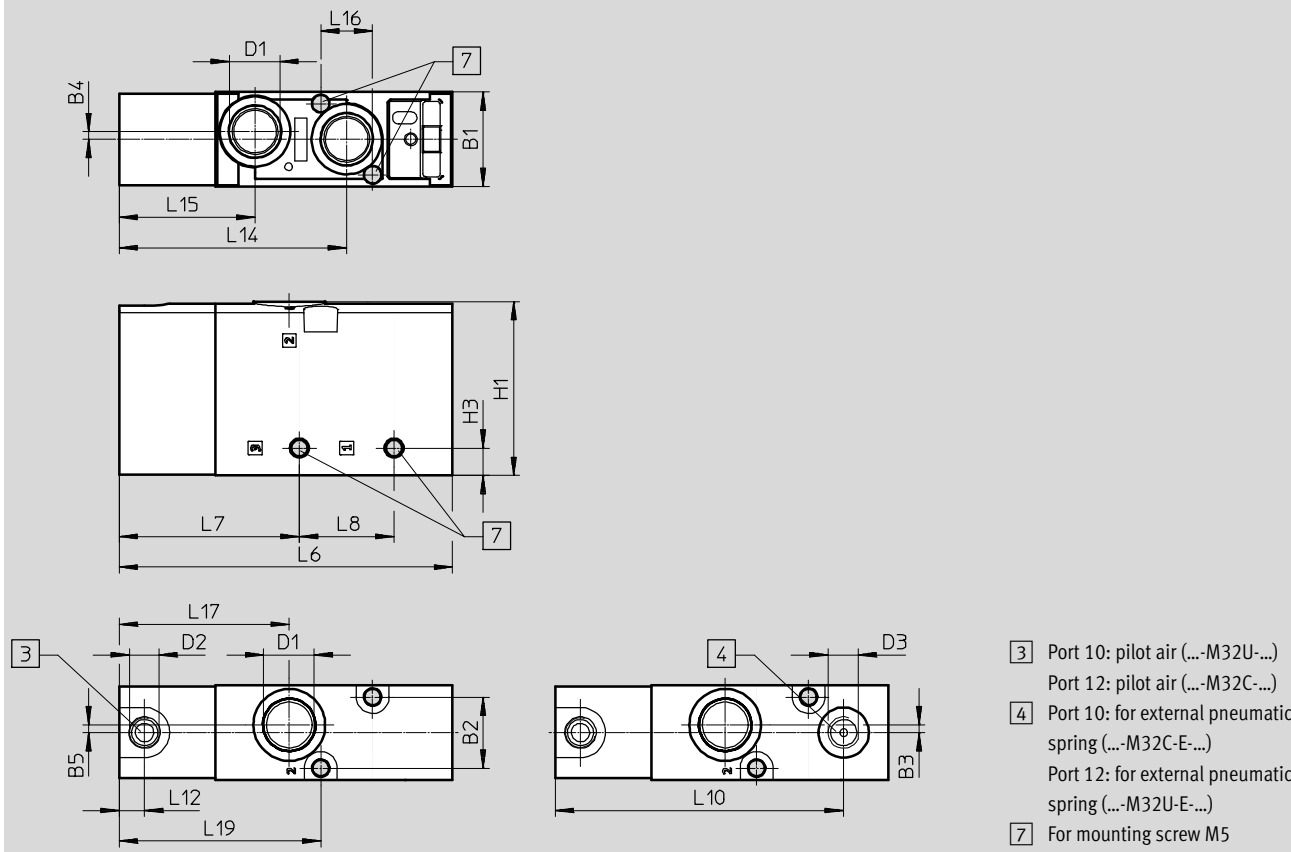

Type	B1	B2	B3	B4	B5	D1	D2	D3	H1	H3
VUWS-L30-M32C-...-G38	31	23.3	2.5	2.5	2.5	G3/8	G1/8	-	57	9
VUWS-L30-M32U-...-G38								-		
VUWS-L30-M32C-E-...-G38								G1/8		
VUWS-L30-M32U-E-...-G38								G1/8		

Type	L6	L7	L8	L10	L12	L14	L15	L16	L17	L19
VUWS-L30-M32C-...-G38	109.2	59	31	-	8.3	74.5	44.5	17	55.7	66
VUWS-L30-M32U-...-G38				-						
VUWS-L30-M32C-E-...-G38				94.5						
VUWS-L30-M32U-E-...-G38				94.5						

Pneumatic valves VUWS-L, size 30

Technical data

Dimensions

Download CAD data → www.festo.com

5/2-way valve, monostable

5/2-way valve, monostable, external pilot air

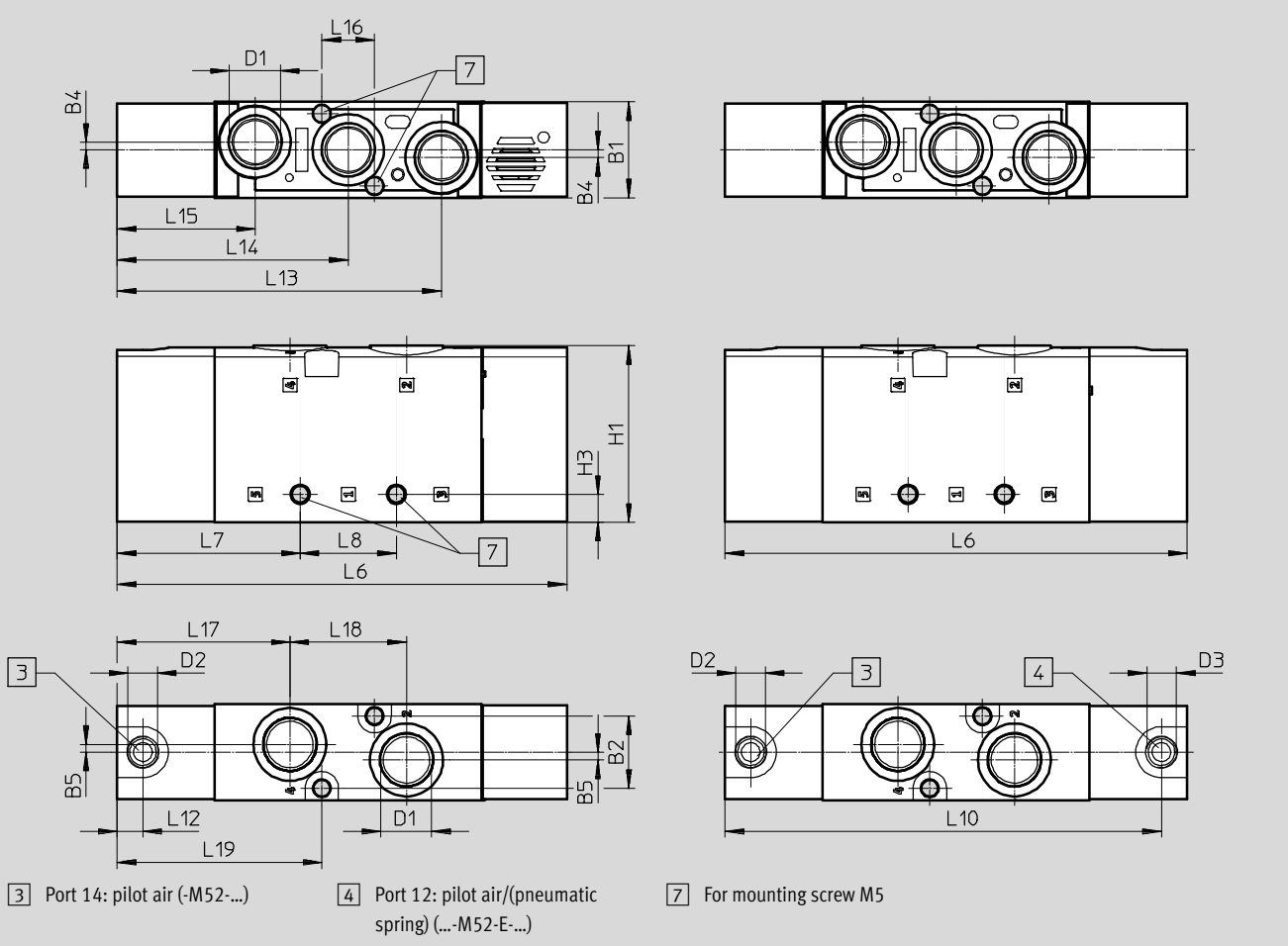

Type	B1	B2	B4	B5	D1	D2	D3	H1	H3
VUWS-L30-M52-...-G38	31	23.3	2.5	2.5	G3/8	G1/8	-	57	9
VUWS-L30-M52-E-G38							G1/8		

Type	L6	L7	L8	L10	L12	L13	L14	L15	L16	L17	L18	L19
VUWS-L30-M52-...-G38	145	59	31	-	8.3	104.5	74.5	44.5	17	55.7	37.6	66
VUWS-L30-M52-E-G38				140.7								

Pneumatic valves VUWS-L, size 30

Technical data

Dimensions

Download CAD data → www.festo.com

5/2-way valve, bistable, 5/3-way valve

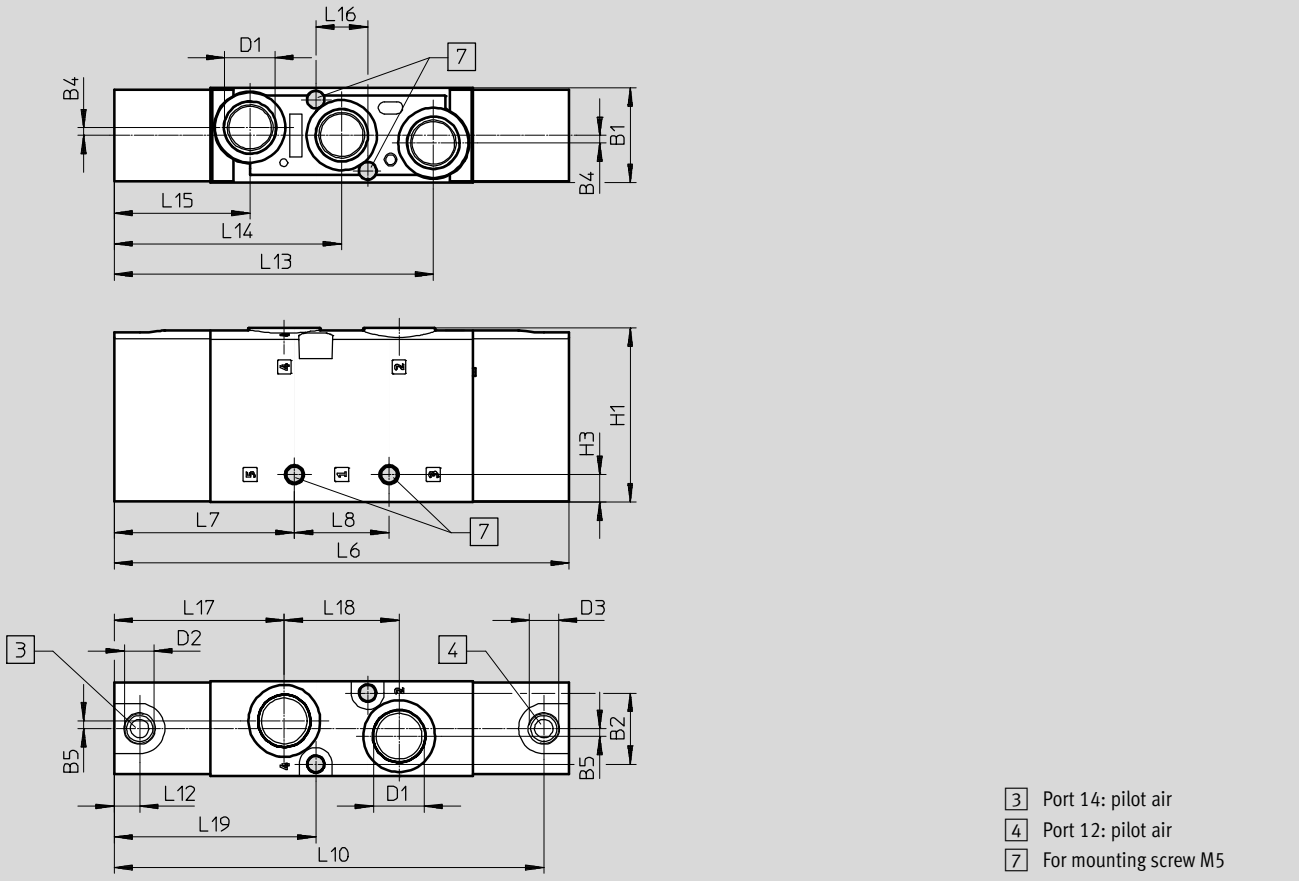

Type	B1	B2	B4	B5	D1	D2	D3	H1	H3
VUWS-L30-P53-...-M-G38	31	23.3	2.5	2.5	G3/8	G1/8	G1/8	57	9
VUWS-L30-B52-G38									

Type	L6	L7	L8	L10	L12	L13	L14	L15	L16	L17	L18	L19
VUWS-L30-P53-...-M-G38	149	59	31	140.7	8.3	104.5	74.5	44.5	17	55.7	37.6	66
VUWS-L30-B52-G38												

Pneumatic valves VUWS-L, size 30

Technical data

Dimensions

Foot mounting

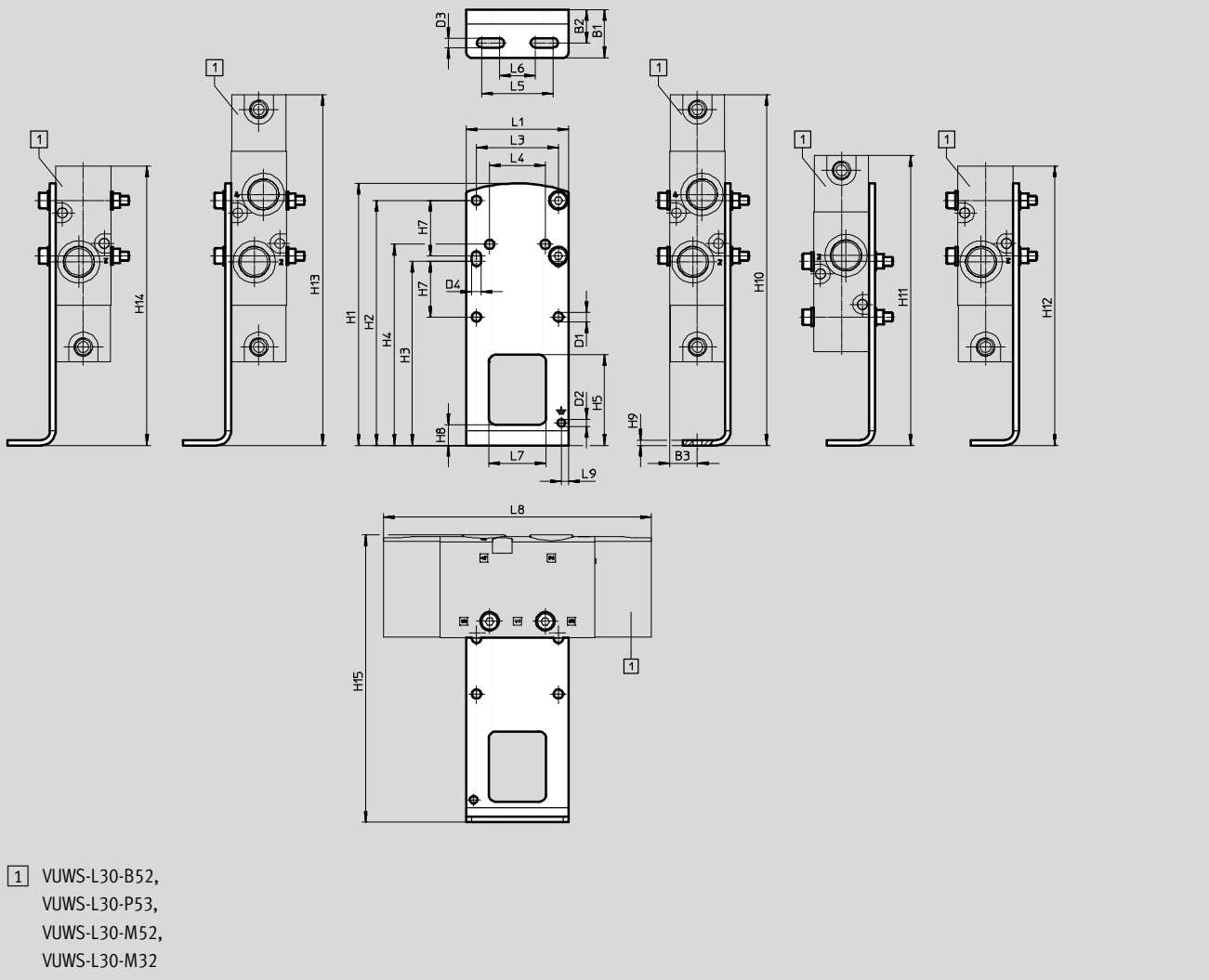

Type		B1	B2	B3	D1 Ø	D2 Ø	D3	D4	H1	H2	H3
VAME-B10-30-A	VUWS-L30-B52/P53	26.8	18.5	15.5	5.2	4.2	5.2	5.2	146	136.5	102.5
	VUWS-L30-M52-E										
	VUWS-L30-M52										
	VUWS-L30-M32										

Type		H4	H5	H7	H8	H9	H10	H11	H12	H13	H14
VAME-B10-30-A	VUWS-L30-B52/P53	112	50.5	31	11.5	3	195.5	161.5	195.5	195.5	195.5
	VUWS-L30-M52-E							197.2	191.5	191.5	155.7
	VUWS-L30-M52										
	VUWS-L30-M32										

Type		H15	L1	L3	L4	L5	L6	L7	L8	L9
VAME-B10-30-A	VUWS-L30-B52/P53	160	57	45.6	31	40	20	32	149	4.1
	VUWS-L30-M52-E								145	109.2
	VUWS-L30-M52									
	VUWS-L30-M32									

Pneumatic valves VUWS-L, size 30

Technical data

Dimensions

Wall mounting

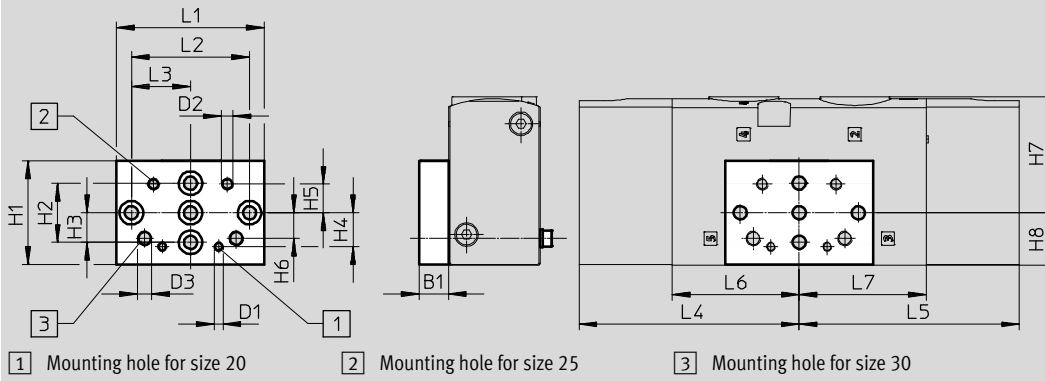

Type		B1	D1	D2	D3	H1	H2	H3	H4	H5	H6
VAME-B10-20-W	VUWS-L30-B52/P53	10	M3	M4	M5	35	20	10	11.5	9.7	8.7
	VUWS-L30-M52										
	VUWS-L30-M32										

Type		H7	H8	L1	L2	L3	L4	L5	L6	L7
VAME-B10-20-W	VUWS-L30-B52/P53	39.3	17.7	50	40	20	74.5	74.5	43	43
	VUWS-L30-M52									-
	VUWS-L30-M32									-



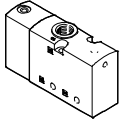
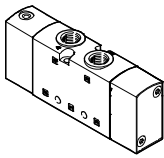
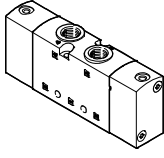

Pneumatic valves VUWS-L, size 30

Ordering data

Ordering data – Pneumatic valves				
	Code	Valve function	Part No.	Type
3/2-way valve				
	Normally closed, monostable			
	M32C-A	Pneumatic spring return, internal pneumatic spring, direction of flow not reversible	575576	VUWS-L30-M32C-A-G38
	M32C-E	Pneumatic spring return, external pneumatic spring, direction of flow reversible	575577	VUWS-L30-M32C-E-G38
	M32C-M	Mechanical spring return, direction of flow reversible	575578	VUWS-L30-M32C-M-G38
	Normally open, monostable			
	M32U-A	Pneumatic spring return, internal pneumatic spring, direction of flow not reversible	575591	VUWS-L30-M32U-A-G38
	M32U-E	Pneumatic spring return, external pneumatic spring, direction of flow reversible	575592	VUWS-L30-M32U-E-G38
	M32U-M	Mechanical spring return, direction of flow reversible	575593	VUWS-L30-M32U-M-G38
	5/2-way valve			
	Monostable			
	M52-A	Pneumatic spring return, internal pneumatic spring, direction of flow not reversible	575600	VUWS-L30-M52-A-G38
	M52-E	Pneumatic spring return, external pneumatic spring, direction of flow reversible	575601	VUWS-L30-M52-E-G38
	M52-M	Mechanical spring return, direction of flow reversible	575608	VUWS-L30-M52-M-G38
	Bistable			
B52	Direction of flow reversible	575615	VUWS-L30-B52-G38	
5/3-way valve				
	5/3-way valve			
	P53C	Closed, mechanical spring return, direction of flow reversible	575622	VUWS-L30-P53C-M-G38
	P53E	Exhausted, mechanical spring return, direction of flow reversible	575636	VUWS-L30-P53E-M-G38
	P53U	Pressurised, mechanical spring return, direction of flow reversible	575629	VUWS-L30-P53U-M-G38

Pneumatic valves VUWS-L, size 30

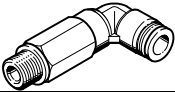
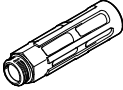

Accessories

Ordering data					
	Description		Part No.	Type	PU ¹⁾
Push-in fitting with internal hex					
	Connecting thread G1/8 for tubing O.D.	4 mm	186106	QS-G1/8-4-I	10
			133008	QS-G1/8-4-I-100	100
	Connecting thread G3/8 for tubing O.D.	6 mm	186107	QS-G1/8-6-I	10
			133009	QS-G1/8-6-I-100	100
		8 mm	186111	QS-G3/8-8-I	10
		10 mm	186113	QS-G3/8-10-I	10
	12 mm	186114	QS-G3/8-12-I	10	
Angled push-in fitting with external hex					
	Connecting thread G3/8 for tubing O.D.	8 mm	186121	QSL-G3/8-8	10
			132055	QSL-G3/8-8-50	50
	10 mm	186123	QSL-G3/8-10	10	
		132056	QSL-G3/8-10-20	20	
	12 mm	186124	QSL-G3/8-12	10	
		132057	QSL-G3/8-12-20	20	
Angled push-in fitting, long, with external hex					
	Connecting thread G3/8 for tubing O.D.	8 mm	186132	QSLL-G3/8-8	10
		10 mm	186134	QSLL-G3/8-10	10
		12 mm	186135	QSLL-G3/8-12	10
Silencers					
	With connecting thread G, metal design	G3/8	6843	U-3/8-B	1
	With connecting thread G, sintered design, long	G3/8	1205862	AMTE-M-LH-G38	10

1) Packaging unit

Pneumatic valves VUWS-L, size 30

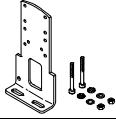
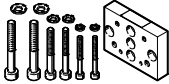
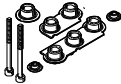
Accessories

Ordering data			
Description	Weight [g]	Part No.	Type
Foot mounting			
	Set for mounting valves, comprising: <ul style="list-style-type: none"> • Mounting bracket and • Screw set for mounting 	–	8026337 VAME-B10-30-A
Wall mounting			
	Set for mounting valves for size 20, 25, 30, comprising: <ul style="list-style-type: none"> • Wall mounting and • Screw set for mounting 	53	576413 VAME-B10-20-W
Set of spare parts			
	Set comprising: <ul style="list-style-type: none"> • Seals and • Screws 	–	8035637 VAME-B10-30-MK
Inscription label			
	40 pieces in frame	–	565306 ASLR-C-E4

Pneumatic valves VUWS/valve manifold VTUS

Order code – Manifold block

VABM	-	B10	-		-
Manifold assembly parts					
Manifold block		VABM			
Valve series					
VUWS		B10			
Valve width					
21 mm				20	
26.5 mm				25	
31 mm				30	
Connection type					
Supply manifold					-
Compact manifold block					S
Standard manifold block					E
Extension module for standard manifold block					EEE

	-		-		-	
Assembly						
E						Supply manifold for mounting at one end
-						Standard mounting
Port for valve function						
-						Manifold block for 5/2- and 5/3-way valves
P3						Manifold block for 3/2-way valves
P53						Supply manifold
Number of valve positions						
2 ... 10						2 to 10
Pneumatic connections 1, 3, 5						
G14						G 1/4
G38						G 3/8
G12						G 1/2
G34						G 3/4

Manifold block VABM

Technical data – Manifold block, size 20

-  Flow rate
Up to 700 l/min

-  Valve width
21 mm

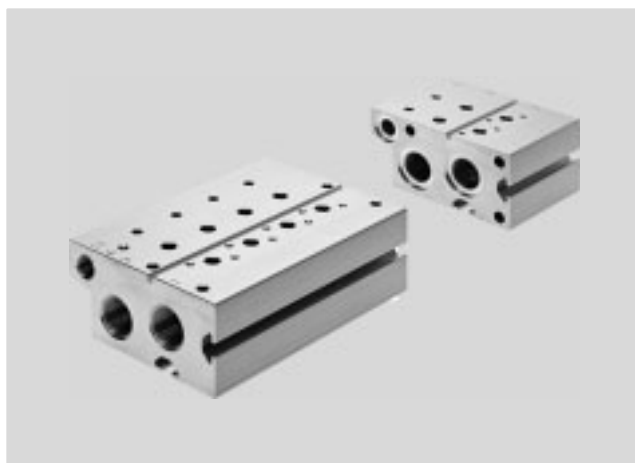

General technical data								
Valve function	Manifold block standard		Extension module for standard manifold block		Manifold block compact		Supply manifold	
	3/2	5/2, 5/3	3/2	5/2, 5/3	3/2	5/2, 5/3	On both sides	On one side
Valve function	3/2	5/2, 5/3	3/2	5/2, 5/3	3/2	5/2, 5/3	3/2, 5/2, 5/3	
Grid dimension [mm]	22							
Type of mounting	With through-hole						With mounting bracket	
Max. number of valve positions	10	10	2	2	10		10	4
Port 1	G3/8	G3/8	G3/8	G3/8	G1/4	G1/4	G3/8	G3/8
Port 3	G3/8	G3/8	G3/8	G3/8	G1/4	G1/4	–	–
Port 5	–	G3/8	–	G3/8	–	G1/4	–	–
Port 12	G1/8	G1/8	G1/8	G1/8	–	–	–	–
Port 14	–	G1/8	–	G1/8	–	–	–	–
CRC ¹⁾	2 ¹⁾							

1) Corrosion resistance class CRC 2 to Festo standard FN 940070
Moderate corrosion stress. Indoor applications in which condensation may occur. External visible parts with primarily decorative requirements for the surface and which are in direct contact with the ambient atmosphere typical for industrial applications.

Weight [g]									
Valve positions	2	3	4	5	6	7	8	9	10
Manifold block for 3/2-way valves, standard									
VABM-B10-20E-G38-...-P3	449	574	699	825	950	1075	1200	1326	1451
Manifold block, extension module for 3/2-way valves, standard									
VABM-B10-20EEE-G38-2-P3	324	–	–	–	–	–	–	–	–
Manifold block for 5/2- and 5/3-way valves, standard									
VABM-B10-20E-G38-...	680	866	1053	1239	1425	1612	1798	1985	2171
Manifold block, extension module for 5/2- and 5/3-way valves, standard									
VABM-B10-20EEE-G38-2	492	–	–	–	–	–	–	–	–
Manifold block for 3/2-way valves, compact									
VABM-B10-20S-G14-...-P3	280	360	441	521	601	681	762	842	922
Manifold block for 5/2- and 5/3-way valves, compact									
VABM-B10-20S-G14-...	344	439	535	630	726	821	917	1012	1108
Supply manifold for mounting on both sides									
VABM-B10-20-G38-...-P53	226	268	310	352	395	437	479	521	563
Supply manifold for mounting on one side									
VABM-B10-20-G38-...-P53-E	240	282	324	–	–	–	–	–	–

Information on materials	
Materials	Wrought aluminium alloy
Note on materials	RoHS compliant

Manifold block VABM

Technical data – Manifold block, size 20

Dimensions

Manifold block for 3/2-way valves, standard

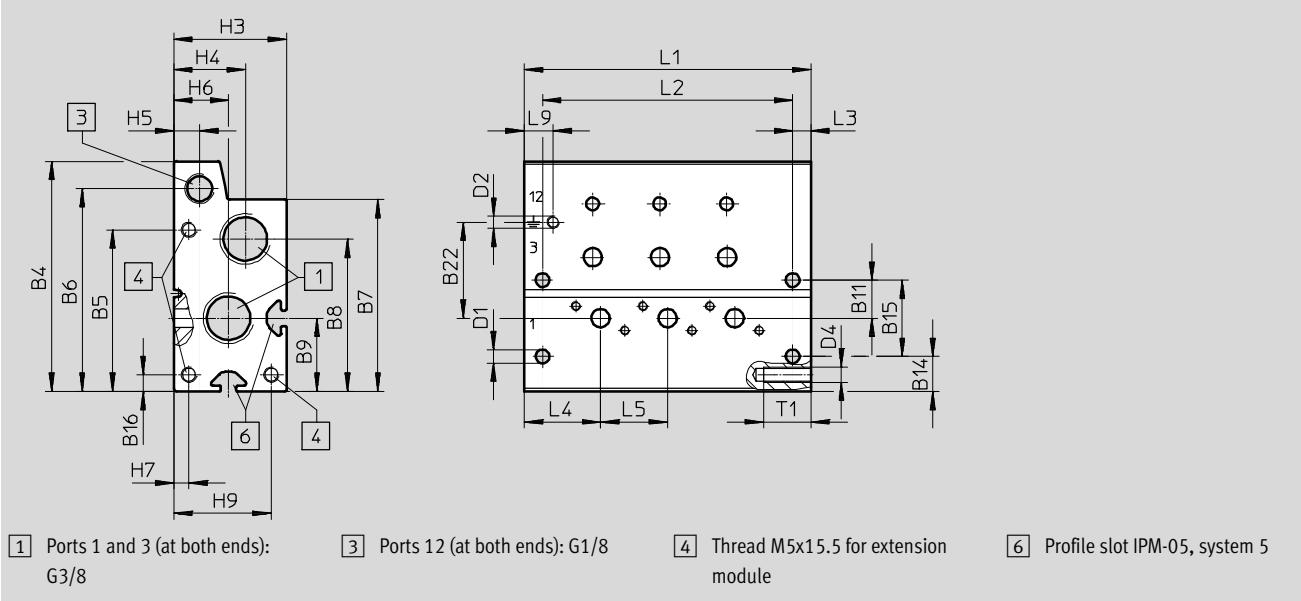

Type	B4	B5	B6	B7	B8	B9	B11	B14	B15	B16	B22
VABM-B10-20E-G38-...-P3	75.5	53	66.5	63	50	24	12.5	11.5	25	5.5	31.5

Type	D1 Ø	D2	D4	H3	H4	H5	H6	H7	H9	L3	L4	L5	L9	T1
VABM-B10-20E-G38-...-P3	4.5	M4x6.5	M5	37	23.5	8.5	18	5	32	6	25	22	9.5	15.5

Valve positions	2	3	4	5	6	7	8	9	10
L1 [mm]	72	94	116	138	160	182	204	226	248
L2 [mm]	60	82	104	126	148	170	192	214	236

Manifold block VABM

Technical data – Manifold block, size 20

Dimensions

Manifold block, extension module for 3/2-way valves, standard

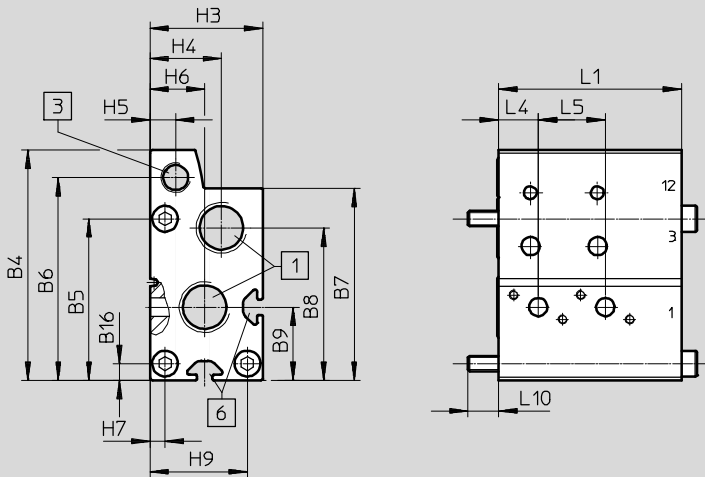

- 1 Ports 1 and 3: threaded port G3/8 at one end
- 3 Threaded port 12: G1/8 at one end
- 6 Profile slot IPM-05, system 5

Type	B4	B5	B6	B7	B8	B9	B16	H3	H4	H5	H6	H7	H9	L4	L5	L10
VABM-B10-20EEE-G38-2-P3	75.5	53	66.5	63	50	24	5.5	37	23.5	8.5	18	5	32	13	22	10

Valve positions	2
L1 [mm]	60

Manifold block VABM

Technical data – Manifold block, size 20

Dimensions

Manifold block for 5/2- and 5/3-way valves, standard

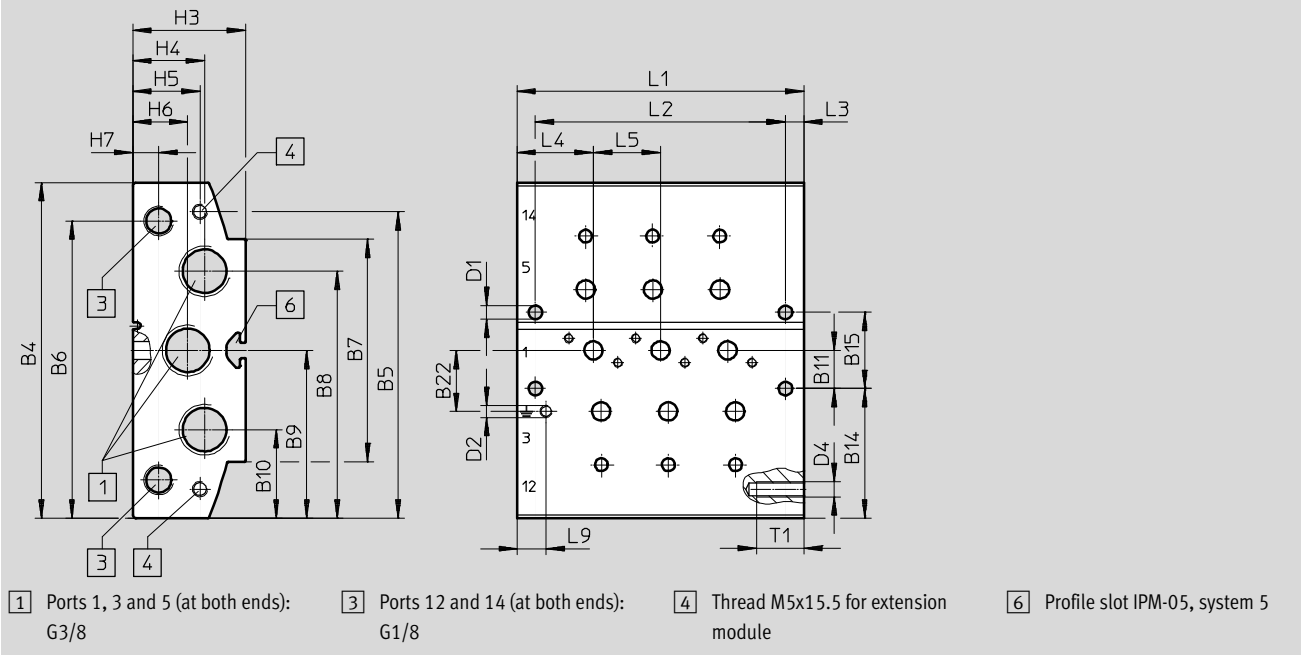

Type	B4	B5	B6	B7	B8	B9	B10	B11	B14	B15	B22
VABM-B10-20E-G38-...	110	100.5	97.5	73	81	55	29	12.5	42.5	25	20

Type	D1 Ø	D2	D4	H3	H4	H5	H6	H7	L3	L4	L5	L9	T1
VABM-B10-20E-G38-...	4.5	M4x6.5	M5	37	23.5	22	18	8.5	6	25	22	9.5	15.5

Valve positions	2	3	4	5	6	7	8	9	10
L1 [mm]	72	94	116	138	160	182	204	226	248
L2 [mm]	60	82	104	126	148	170	192	214	236

Manifold block VABM

Technical data – Manifold block, size 20

Dimensions

Manifold block, extension module for 5/2- and 5/3-way valves, standard

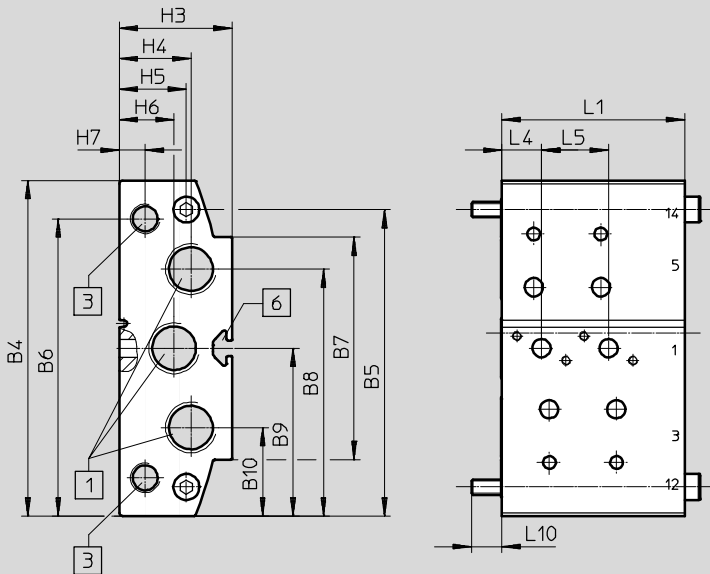

- 1 Ports 1, 3 and 5: threaded port G3/8 at one end
- 3 Threaded ports 12 and 14: G1/8 at one end
- 6 Profile slot IPM-05, system 5

Type	B4	B5	B6	B7	B8	B9	B10	H3	H4	H5	H6	H7	L4	L5	L10
VABM-B10-20EEE-G38-2	110	100.5	97.5	73	81	55	29	37	23.5	22	18	8.5	13	22	10

Valve positions	2
L1 [mm]	60

Manifold block VABM

Technical data – Manifold block, size 20

Dimensions

Manifold block for 3/2-way valves, compact

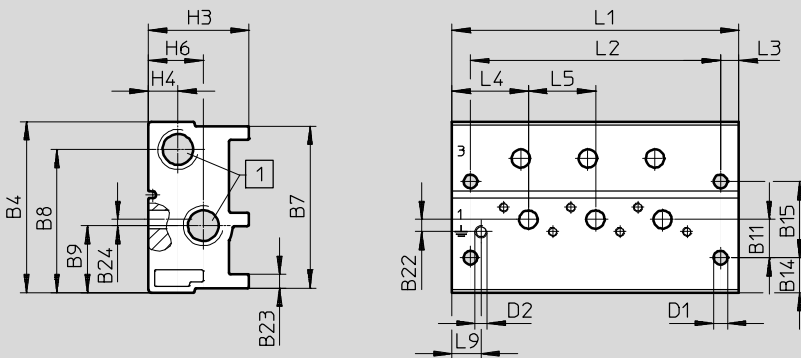

1 Ports 1 and 3 (at both ends):
G1/4

Type	B4	B7	B8	B9	B11	B14	B15	B22	B23	B24
VABM-B10-20S-G14-...-P3	56.1	53.1	47.1	22	12.5	11.5	25	4	5	2

Type	D1 Ø	D2	H3	H4	H6	L3	L4	L5	L9
VABM-B10-20S-G14-...-P3	4.5	M4x6.5	33	9.7	18	6	25	22	9.5

Valve positions	2	3	4	5	6	7	8	9	10
L1 [mm]	72	94	116	138	160	182	204	226	248
L2 [mm]	60	82	104	126	148	170	192	214	236

Dimensions

Manifold block for 5/2- and 5/3-way valves, compact

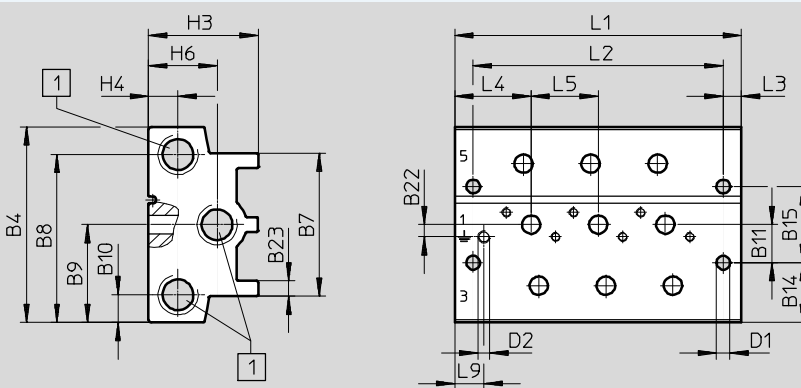

1 Ports 1, 3 and 5 (at both ends):
G1/4

Type	B4	B7	B8	B9	B10	B11	B14	B15	B22	B23
VABM-B10-20S-G14-...	64.2	47	55.1	32.1	9.1	12.5	149.6	25	4	5

Type	D1 Ø	D2	H3	H4	H6	L3	L4	L5	L9
VABM-B10-20S-G14-...	4.5	M4x6.5	36	9.7	22.5	6	25	22	9.5

Valve positions	2	3	4	5	6	7	8	9	10
L1 [mm]	72	94	116	138	160	182	204	226	248
L2 [mm]	60	82	104	126	148	170	192	214	236

Manifold block VABM

Technical data – Manifold block, size 20

Dimensions

Supply manifold, mounting on both sides

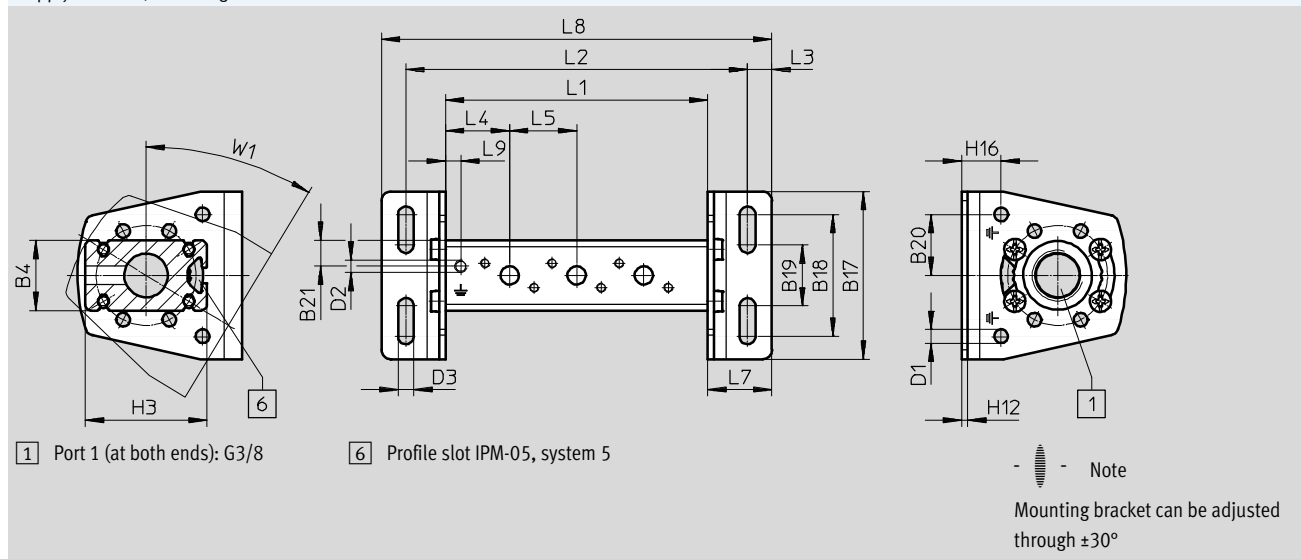

Type	B4	B17	B18	B19	B20	B21	D1 \varnothing	D2	D3 \varnothing	H3	H12	H16	L3	L4	L5	L7	L9	W1
VABM-B10-20-G38-...-P53	23	55	40	20	20	8.5	4.5	M4x6.5	5.2	40	2	13	9	21	22	22	5	31.3°

Valve positions	2	3	4	5	6	7	8	9	10
L1 [mm]	64	86	108	130	152	174	196	218	240
L2 [mm]	90	112	134	156	178	200	222	244	266
L8 [mm]	106	128	150	172	194	216	238	260	282

Dimensions

Supply manifold, mounting on one side

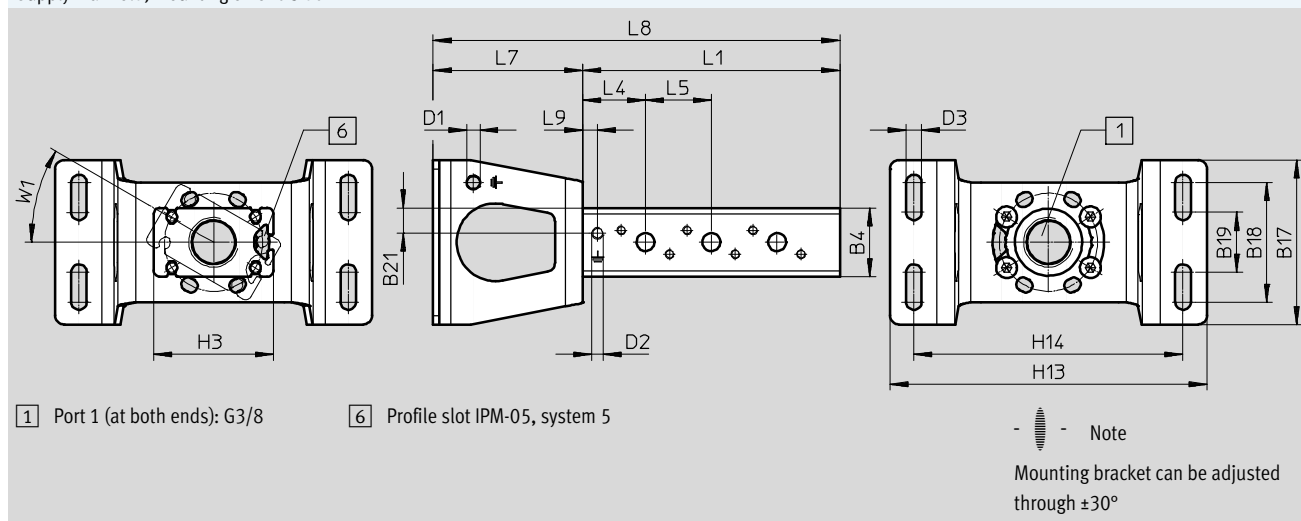







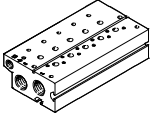

Type	B4	B17	B18	B19	B21	D1 \varnothing	D2	D3 \varnothing	H3	H13	H14	L4	L5	L7	L9	W1
VABM-B10-20-G38-...-P53-E	23	55	40	20	8.5	4.5	M4x6.5	5.2	40	106	90	21	22	50	5	30°

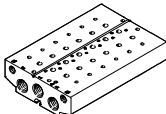
Valve positions	2	3	4
L1 [mm]	64	86	108
L8 [mm]	114	136	158

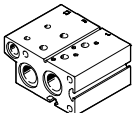
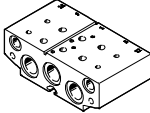
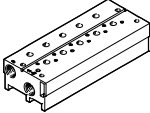
Manifold block VABM

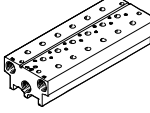
Ordering data – Manifold block, size 20

Ordering data				
Description	Valve positions	Part No.	Type	
Standard manifold block				
 <p>For 3/2-way valves, incl. seals and screws for mounting valves</p> <p>-  - Note Blanking plugs for sealing the supply ports (1, 3 and 14) at one end are included in the scope of delivery.</p>	2	576441	VABM-B10-20E-G38-2-P3	
	3	576442	VABM-B10-20E-G38-3-P3	
	4	576443	VABM-B10-20E-G38-4-P3	
	5	576444	VABM-B10-20E-G38-5-P3	
	6	576445	VABM-B10-20E-G38-6-P3	
	7	576446	VABM-B10-20E-G38-7-P3	
	8	576447	VABM-B10-20E-G38-8-P3	
	9	576448	VABM-B10-20E-G38-9-P3	
	10	576449	VABM-B10-20E-G38-10-P3	
	 <p>For 5/2 and 5/3-way valves, incl. seals and screws for valve assembly</p> <p>-  - Note Blanking plugs for sealing the supply ports (1, 3, 5, 12 and 14) at one end are included in the scope of delivery.</p>	2	576339	VABM-B10-20E-G38-2
3		576340	VABM-B10-20E-G38-3	
4		576341	VABM-B10-20E-G38-4	
5		576342	VABM-B10-20E-G38-5	
6		576343	VABM-B10-20E-G38-6	
7		576344	VABM-B10-20E-G38-7	
8		576345	VABM-B10-20E-G38-8	
9		576346	VABM-B10-20E-G38-9	
10		576347	VABM-B10-20E-G38-10	
Manifold block, extension module for standard manifold block				
 <p>For 3/2-way valves, incl. seals and screws for valve assembly</p>	2	576490	VABM-B10-20EEE-G38-2-P3	
 <p>For 5/2 and 5/3-way valves, incl. seals and screws for valve assembly</p>	2	576489	VABM-B10-20EEE-G38-2	
Compact manifold block				
 <p>For 3/2-way valves, incl. seals and screws for mounting valves</p> <p>-  - Note Blanking plugs for sealing the supply ports (1 and 3) at one end are included in the scope of delivery.</p>	2	576465	VABM-B10-20S-G14-2-P3	
	3	576466	VABM-B10-20S-G14-3-P3	
	4	576467	VABM-B10-20S-G14-4-P3	
	5	576468	VABM-B10-20S-G14-5-P3	
	6	576469	VABM-B10-20S-G14-6-P3	
	7	576470	VABM-B10-20S-G14-7-P3	
	8	576471	VABM-B10-20S-G14-8-P3	
	9	576472	VABM-B10-20S-G14-9-P3	
	10	576473	VABM-B10-20S-G14-10-P3	
	 <p>For 5/2 and 5/3-way valves, incl. seals and screws for valve assembly</p> <p>-  - Note Blanking plugs for sealing the supply ports (1, 3 and 5) at one end are included in the scope of delivery.</p>	2	576417	VABM-B10-20S-G14-2
3		576418	VABM-B10-20S-G14-3	
4		576419	VABM-B10-20S-G14-4	
5		576420	VABM-B10-20S-G14-5	
6		576421	VABM-B10-20S-G14-6	
7		576422	VABM-B10-20S-G14-7	
8		576423	VABM-B10-20S-G14-8	
9		576424	VABM-B10-20S-G14-9	
10		576425	VABM-B10-20S-G14-10	

Manifold block VABM

Ordering data – Manifold block, size 20

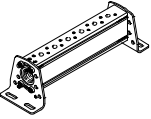
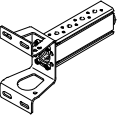



Ordering data			
Description	Valve positions	Part No.	Type
Supply manifold			
 <p>For mounting on both sides, incl. seals and screws for mounting valves</p>	2	576363	VABM-B10-20-G38-2-P53
	3	576364	VABM-B10-20-G38-3-P53
	4	576365	VABM-B10-20-G38-4-P53
	5	576366	VABM-B10-20-G38-5-P53
	6	576367	VABM-B10-20-G38-6-P53
	7	576368	VABM-B10-20-G38-7-P53
	8	576369	VABM-B10-20-G38-8-P53
	9	576370	VABM-B10-20-G38-9-P53
	10	576371	VABM-B10-20-G38-10-P53
	 <p>For mounting on one side, incl. seals and screws for valve assembly</p>	2	576414
3		576415	VABM-B10-20-G38-3-P53-E
4		576416	VABM-B10-20-G38-4-P53-E

-  - Note

Blanking plug for sealing the supply port (1) at one end included in the scope of delivery.

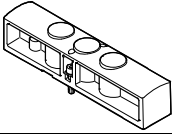
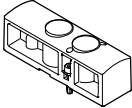

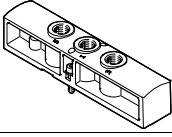
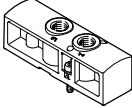

Manifold block VABM

Accessories – Manifold block, size 20

Ordering data				
Description		Weight [g]	Part No.	Type
Blanking plate				
	For valve position on manifold block for 5/2-, 5/3-way valves	78	576410	VABB-B10-20-E
	For valve position on manifold block for 3/2-way valves	56	576411	VABB-B10-20-E-P3
	For valve position on supply manifold	13	576409	VABB-B10-20-A
Supply plate				
	For valve position on manifold block for 5/2-, 5/3-way valves	78	576492	VABF-B10-20-P1A4-G18
	For valve position on manifold block for 3/2-way valves	56	576493	VABF-B10-20-P1A4-G18-P3
Supply plate				
	For valve position on supply manifold	13	576491	VABF-B10-20-P1-G18

Manifold block VABM





Accessories – Manifold block, size 20

Ordering data					
	Description		Part No.	Type	PU ¹⁾
Push-in fitting with external hex					
	Connecting thread M5 for tubing O.D.	12 mm	186350	QS-G1/4-12	10
	Connecting thread G3/8 for tubing O.D.	16 mm	186347	QS-G3/8-16	1
Push-in fitting with internal hex					
	Connecting thread M5 for tubing O.D.	4 mm	153315	QSM-M5-4-I	10
	Connecting thread G1/8 for tubing O.D.	4 mm	186106	QS-G1/8-4-I	10
			133008	QS-G1/8-4-I-100	100
		6 mm	186107	QS-G1/8-6-I	10
			133009	QS-G1/8-6-I-100	100
		8 mm	186109	QS-G1/8-8-I	10
			133010	QS-G1/8-8-I-100	100
	Connecting thread G1/4 for tubing O.D.	8 mm	186110	QS-G1/4-8-I	10
		10 mm	186112	QS-G1/4-10-I	10
	Connecting thread G3/8 for tubing O.D.	8 mm	186111	QS-G3/8-8-I	10
		10 mm	186113	QS-G3/8-10-I	10
		12 mm	186114	QS-G3/8-12-I	10
Angled push-in fitting with external hex					
	Connecting thread G1/8 for tubing O.D.	4 mm	186116	QSL-G1/8-4	10
			132048	QSL-G1/8-4-100	100
		6 mm	186117	QSL-G1/8-6	10
			132049	QSL-G1/8-6-100	100
		8 mm	186119	QSL-G1/8-8	10
			132050	QSL-G1/8-8-50	50
	Connecting thread G1/4 for tubing O.D.	8 mm	186120	QSL-G1/4-8	10
			132052	QSL-G1/4-8-50	50
		10 mm	186122	QSL-G1/4-10	10
			132053	QSL-G1/4-10-50	50
		12 mm	186351	QSL-G1/4-12	10
			132054	QSL-G1/4-12-20	20
	Connecting thread G3/8 for tubing O.D.	8 mm	186121	QSL-G3/8-8	10
			132055	QSL-G3/8-8-50	50
		10 mm	186123	QSL-G3/8-10	10
132056			QSL-G3/8-10-20	20	
12 mm		186124	QSL-G3/8-12	10	
		132057	QSL-G3/8-12-20	20	
Angled push-in fitting with external hex					
	Connecting thread G1/8 for tubing O.D.	4 mm	186116	QSL-G1/8-4	10
			132048	QSL-G1/8-4-100	100
		6 mm	186117	QSL-G1/8-6	10
			132049	QSL-G1/8-6-100	100
		8 mm	186119	QSL-G1/8-8	10
			132050	QSL-G1/8-8-50	50

1) Packaging unit

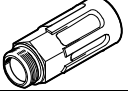
Manifold block VABM

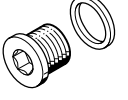
Accessories – Manifold block, size 20

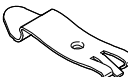
Ordering data					
	Description	Part No.	Type	PU ¹⁾	
Silencer					
	With connecting thread G, polymer design	G1/8	2307	U-1/8	1
			534222	U-1/8-50	50
		G1/4	2316	U-1/4	1
			534223	U-1/4-20	20
		G3/8	534224	U-3/8-20	20
			With connecting thread G, metal design	G1/8	6841
G1/4	6842			U-1/4-B	1
G3/8	6843			U-3/8-B	1
	With connecting thread G, sintered design, long	G1/4	1205861	AMTE-M-LH-G14	20
		G3/8	1205862	AMTE-M-LH-G38	10
Blanking plug					
	With connecting thread G	G1/8	3568	B-1/8	10
			534213	B-1/8-100	100
		G1/4	3569	B-1/4	10
			534214	B-1/4-50	50
		G3/8	3570	B-3/8	10
			534215	B-3/8-20	20
Separator					
	For creating pressure zones	G1/4	569996	VABD-10-B	1
		G3/8	574483	VABD-14-B	1
H-rail mounting					
	For size 20, for mounting on standard H-rails TH 35-7.5 or TH 35-15 to EN 60715	569998	VAME-T-M4	2	

1) Packaging unit

Manifold block VABM

Technical data – Manifold block, size 25

-  Flow rate
Up to 1300 l/min

-  Valve width
26.5 mm

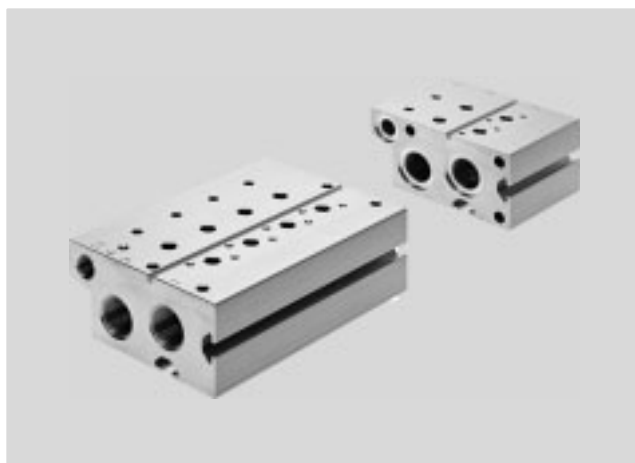

General technical data									
	Manifold block standard		Extension module for standard manifold block		Manifold block compact		Supply manifold		
							On both sides	On one side	
For valves	3/2	5/2, 5/3	3/2	5/2, 5/3	3/2	5/2, 5/3	3/2, 5/2, 5/3		
Grid dimension [mm]	27.5								
Type of mounting	With through-hole						With mounting bracket		
Maximum number of valve positions	10	10	2	2	10	10	10	4	
Port 1	G1/2	G1/2	G1/2	G1/2	G3/8	G3/8	G1/2	G1/2	
Port 3	G1/2	G1/2	G1/2	G1/2	G3/8	G3/8	-	-	
Port 5	-	G1/2	-	G1/2	-	G3/8	-	-	
Port 12	G1/8	G1/8	G1/8	G1/8	-	-	-	-	
Port 14	-	G1/8	-	G1/8	-	-	-	-	
CRC ¹⁾	2 ¹⁾								

1) Corrosion resistance class CRC 2 to Festo standard FN 940070
Moderate corrosion stress. Indoor applications in which condensation may occur. External visible parts with primarily decorative requirements for the surface and which are in direct contact with the ambient atmosphere typical for industrial applications.

Weight [g]									
Valve positions	2	3	4	5	6	7	8	9	10
Manifold block for 3/2-way valves, standard									
VABM-B10-25E-...G12-...-P3	726	960	1194	1428	1662	1896	2130	2364	2598
Manifold block, extension module for 3/2-way valves, standard									
VABM-B10-25EEE-G12-2-P3	340	-	-	-	-	-	-	-	-
Manifold block for 5/2- and 5/3-way valves, standard									
VABM-B10-25E-...G12-...	927	1224	1521	1818	2115	2412	2709	3006	3303
Manifold block, extension module for 5/2- and 5/3-way valves, standard									
VABM-B10-25EEE-G12-2	258	-	-	-	-	-	-	-	-
Manifold block for 3/2-way valves, compact									
VABM-B10-25S-...G38-...-P3	369	488	607	726	845	964	1083	1202	1321
Manifold block for 5/2- and 5/3-way valves, compact									
VABM-B10-25S-...G38-...	438	579	720	861	1002	1143	1284	1425	1566
Supply manifold for mounting on both sides									
VABM-B10-25-...G12-...-P53	258	340	422	504	586	668	750	832	914
Supply manifold for mounting on one side									
VABM-B10-25-G12-...-P53-E	258	340	422	-	-	-	-	-	-

Information on materials	
Materials	Wrought aluminium alloy
Note on materials	RoHS compliant

Manifold block VABM

Technical data – Manifold block, size 25

Dimensions

Manifold block for 3/2-way valves, standard

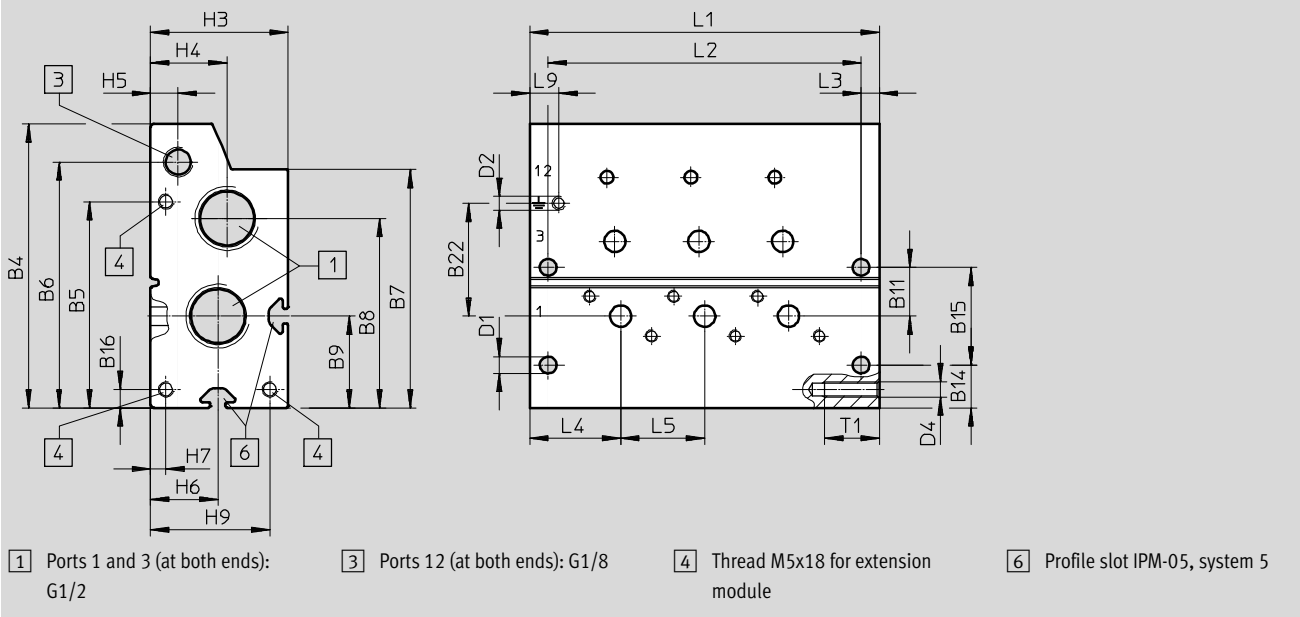

Type	B4	B5	B6	B7	B8	B9	B11	B14	B15	B16	B22
VABM-B10-25-E-...G12-...-P3	93	67.5	80.5	78	62	30	16	14	32	6	37

Type	D1 Ø	D2	D4	H3	H4	H5	H6	H7	H9	L3	L4	L5	L9	T1
VABM-B10-25-E-...G12-...-P3	5.5	M4x9	M5	45	25	9	22	5	39	6	29.8	27.5	9.5	18

Valve positions	2	3	4	5	6	7	8	9	10
L1 [mm]	87	114.5	142	169.5	197	224.5	252	279.5	307
L2 [mm]	75	102.5	130	157.5	185	212.5	240	267.5	295

Manifold block VABM

Technical data – Manifold block, size 25

Dimensions

Manifold block, extension module for 3/2-way valves, standard

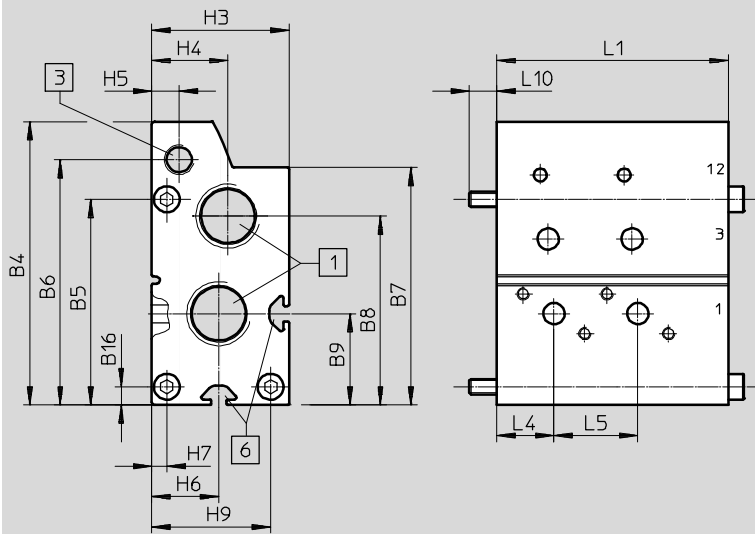

- 1 Ports 1 and 3: threaded port G1/2 at one end
- 3 Threaded port 12: G1/8 at one end
- 6 Profile slot IPM-05, system 5

Type	B4	B5	B6	B7	B8	B9	B16	H3	H4	H5	H6	H7	H9	L4	L5	L10
VABM-B10-25EEE-G12-2-P3	93	67.5	80.5	78	62	30	6	45	25	9	22	5	39	18.8	27.5	9

Valve positions	2
L1 [mm]	76

Manifold block VABM

Technical data – Manifold block, size 25

Dimensions

Manifold block for 5/2- and 5/3-way valves, standard

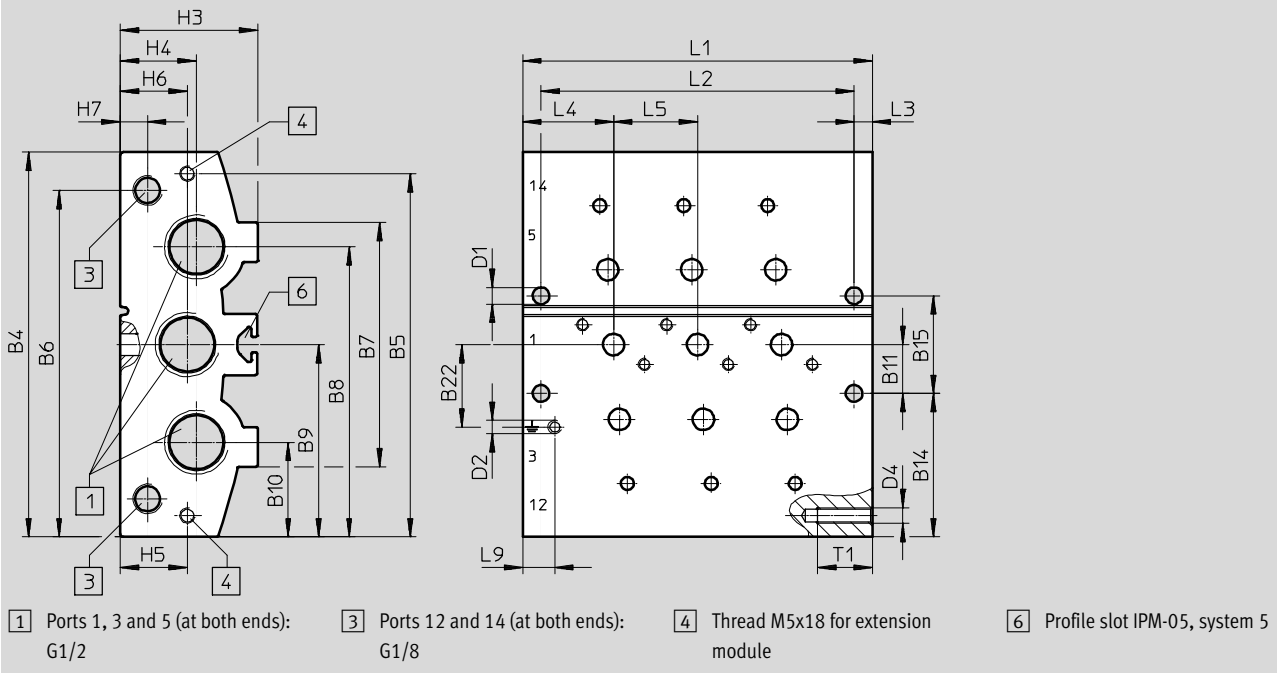

Type	B4	B5	B6	B7	B8	B9	B10	B11	B14	B15	B22
VABM-B10-25E-...-G12-...	126	119	113.5	80	95	63	31	16	47	32	27

Type	D1 Ø	D2	D4	H3	H4	H5	H6	H7	L3	L4	L5	L9	T1
VABM-B10-25E-...-G12-...	5.5	M4x9	M5	45	25	22	22	9	6	29.8	27.5	10.5	18

Valve positions	2	3	4	5	6	7	8	9	10
L1 [mm]	87	114.5	142	169.5	197	224.5	252	279.5	307
L2 [mm]	75	102.5	130	157.5	185	212.5	240	267.5	295

Manifold block VABM

Technical data – Manifold block, size 25

Dimensions

Manifold block, extension module for 5/2- and 5/3-way valves, standard

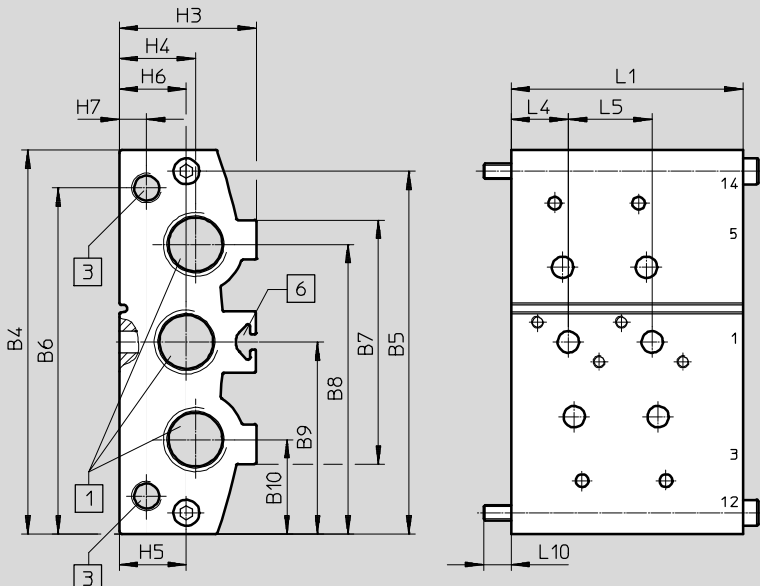

- 1 Ports 1, 3 and 5: threaded port G1/2 at one end
- 3 Threaded ports 12 and 14: G1/8 at one end
- 6 Profile slot IPM-05, system 5

Type	B4	B5	B6	B7	B8	B9	B10	H3	H4	H5	H6	H7	L4	L5	L10
VABM-B10-20EEE-G12-2	126	119	113.5	80	95	63	31	45	25	22	22	9	18.8	27.5	9

Valve positions	2
L1 [mm]	76

Manifold block VABM

Technical data – Manifold block, size 25

Dimensions

Manifold block for 3/2-way valves, compact

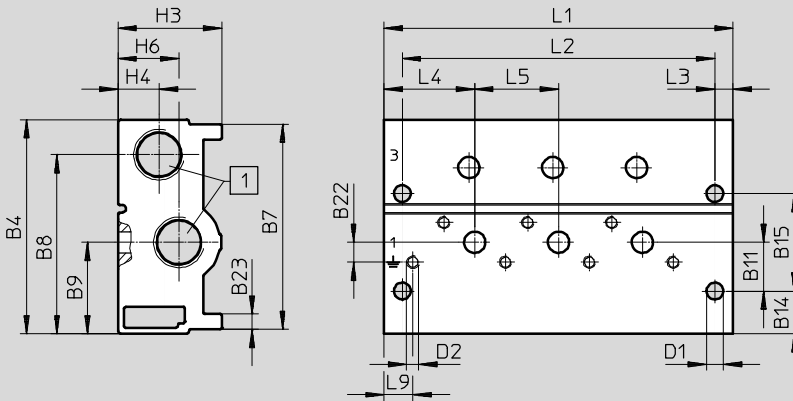

1 Ports 1 and 3 (at both ends):
G3/8

Type	B4	B7	B8	B9	B11	B14	B15	B22	B23
VABM-B10-25S-...G38-...-P3	70.3	67.3	58.8	30	16	14	32	6.5	5

Type	D1 Ø	D2	H3	H4	H6	L3	L4	L5	L9
VABM-B10-25S-...G38-...-P3	5.5	M4x9	34	13.5	20	6	29.8	27.5	9.5

Valve positions	2	3	4	5	6	7	8	9	10
L1 [mm]	87	114.5	142	169.5	197	224.5	252	279.5	307
L2 [mm]	75	102.5	130	157.5	185	212.5	240	267.5	295

Manifold block VABM

Technical data – Manifold block, size 25

Dimensions

Manifold block for 5/2- and 5/3-way valves, compact

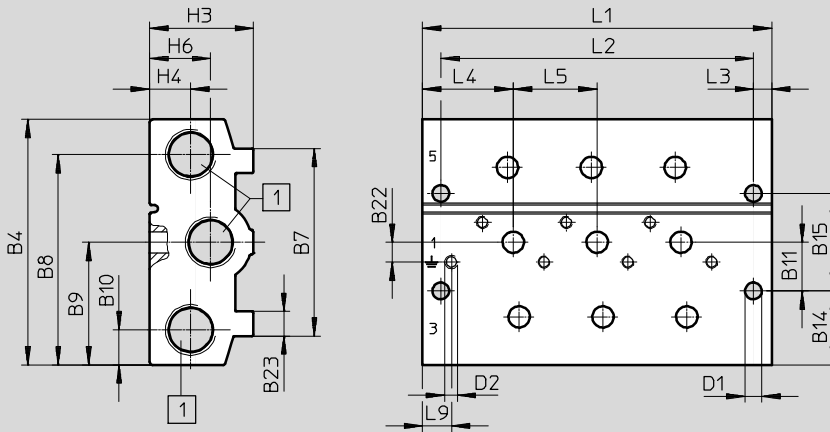

1 Ports 1, 3 and 5 (at both ends):
G3/8

Type	B4	B7	B8	B9	B10	B11	B14	B15	B22	B23
VABM-B10-25S-...G38-...	80.5	61.5	69	40.3	11.5	16	24.3	32	6.5	8

Type	D1 Ø	D2	H3	H4	H6	L3	L4	L5	L9
VABM-B10-25S-...G38-...	5.5	M4x9	34	13.5	20	6	29.8	27.5	9.5

Valve positions	2	3	4	5	6	7	8	9	10
L1 [mm]	87	114.5	142	169.5	197	224.5	252	279.5	307
L2 [mm]	75	102.5	130	157.5	185	212.5	240	267.5	295

Manifold block VABM

Technical data – Manifold block, size 25

Dimensions

Supply manifold, mounting on both sides

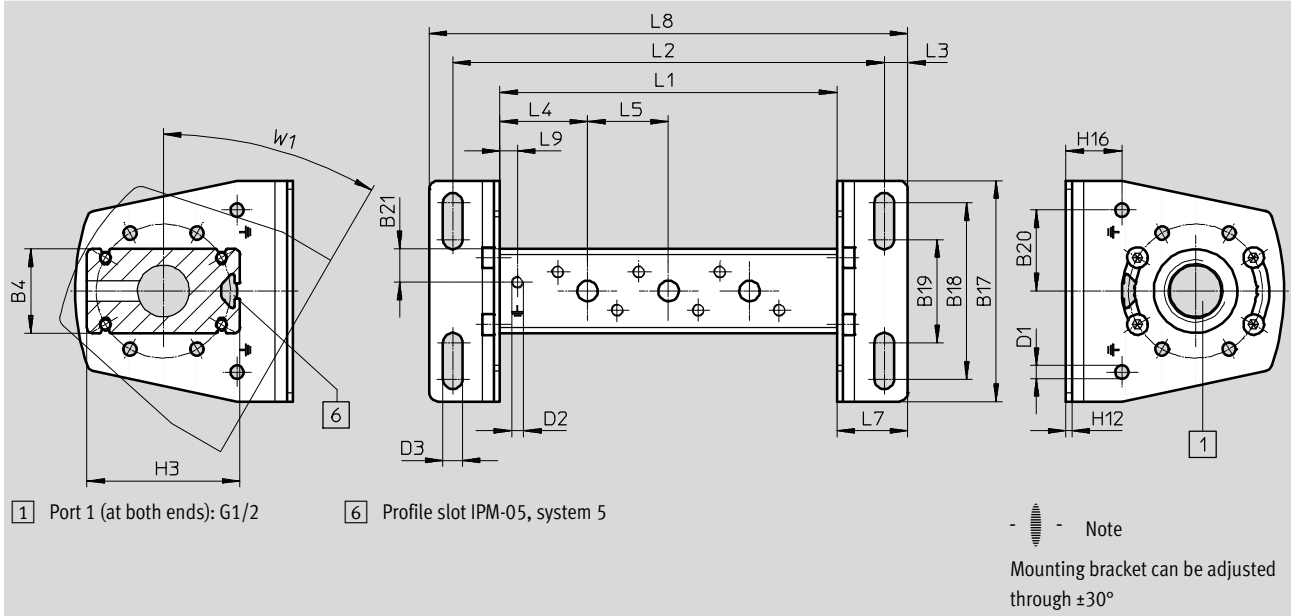

Type	B4	B17	B18	B19	B20	B21	D1 Ø	D2	D3 Ø	H3	H12	H16	L3	L4	L5	L7	L9	W1
VABM-B10-25-G12-...-P53	28.7	75	60	35	27.5	11.4	4.5	M4x9	6.6	52	2	19	8	29.8	27.5	24	6	30

Valve positions	2	3	4	5	6	7	8	9	10
L1 [mm]	87	114.5	142	169.5	197	224.5	252	279.5	307
L2 [mm]	119	146.5	174	201.5	229	256.5	284	311.5	339
L8 [mm]	135	162.5	190	217.5	245	272.5	300	327.5	355

Dimensions

Supply manifold, mounting on one side

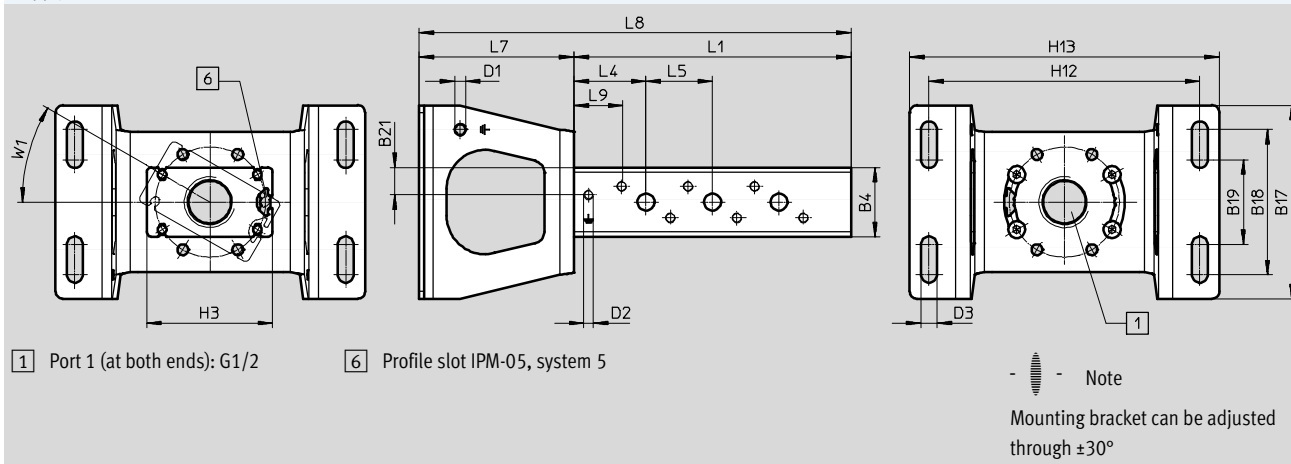







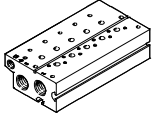

Type	B4	B17	B18	B19	B21	D1 Ø	D2	D3 Ø	H3	H13	H14	L4	L5	L7	L9	W1
VABM-B10-25-G12-...-P53-E	28.7	80	60	35	11.4	4.5	M4x9	6.6	52	128	112	29.8	27.5	64	6	30°

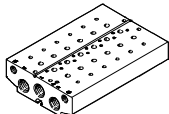
Valve positions	2	3	4
L1 [mm]	87	114.5	142
L8 [mm]	151	178.5	206

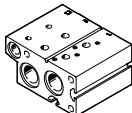
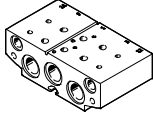
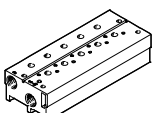
Manifold block VABM

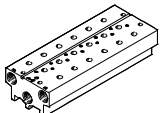
Ordering data – Manifold block, size 25

Ordering data				
Description	Valve positions	Part No.	Type	
Standard manifold block				
 <p>For 3/2-way valves, incl. seals and screws for mounting valves</p> <p>-  - Note Blanking plugs for sealing the supply ports (1, 3 and 14) at one end are included in the scope of delivery.</p>	2	8026279	VABM-B10-25E-G12-2-P3	
	3	8026280	VABM-B10-25E-G12-3-P3	
	4	8026281	VABM-B10-25E-G12-4-P3	
	5	8026282	VABM-B10-25E-G12-5-P3	
	6	8026283	VABM-B10-25E-G12-6-P3	
	7	8026284	VABM-B10-25E-G12-7-P3	
	8	8026285	VABM-B10-25E-G12-8-P3	
	9	8026286	VABM-B10-25E-G12-9-P3	
	10	8026287	VABM-B10-25E-G12-10-P3	
	 <p>For 5/2 and 5/3-way valves, incl. seals and screws for valve assembly</p> <p>-  - Note Blanking plugs for sealing the supply ports (1, 3, 5, 12 and 14) at one end are included in the scope of delivery.</p>	2	8026243	VABM-B10-25E-G12-2
3		8026244	VABM-B10-25E-G12-3	
4		8026245	VABM-B10-25E-G12-4	
5		8026246	VABM-B10-25E-G12-5	
6		8026247	VABM-B10-25E-G12-6	
7		8026248	VABM-B10-25E-G12-7	
8		8026249	VABM-B10-25E-G12-8	
9		8026250	VABM-B10-25E-G12-9	
10		8026251	VABM-B10-25E-G12-10	
Manifold block, extension module for standard manifold block				
 <p>For 3/2-way valves, incl. seals and screws for valve assembly</p>	2	8026316	VABM-B10-25EEE-G12-2-P3	
 <p>For 5/2 and 5/3-way valves, incl. seals and screws for valve assembly</p>	2	8026315	VABM-B10-25EEE-G12-2	
Compact manifold block				
 <p>For 3/2-way valves, incl. seals and screws for mounting valves</p> <p>-  - Note Blanking plugs for sealing the supply ports (1 and 3) at one end are included in the scope of delivery.</p>	2	8026297	VABM-B10-25S-G38-2-P3	
	3	8026298	VABM-B10-25S-G38-3-P3	
	4	8026299	VABM-B10-25S-G38-4-P3	
	5	8026300	VABM-B10-25S-G38-5-P3	
	6	8026301	VABM-B10-25S-G38-6-P3	
	7	8026302	VABM-B10-25S-G38-7-P3	
	8	8026303	VABM-B10-25S-G38-8-P3	
	9	8026304	VABM-B10-25S-G38-9-P3	
	10	8026305	VABM-B10-25S-G38-10-P3	
	 <p>For 5/2 and 5/3-way valves, incl. seals and screws for valve assembly</p> <p>-  - Note Blanking plugs for sealing the supply ports (1, 3 and 5) at one end are included in the scope of delivery.</p>	2	8026261	VABM-B10-25S-G38-2
3		8026262	VABM-B10-25S-G38-3	
4		8026263	VABM-B10-25S-G38-4	
5		8026264	VABM-B10-25S-G38-5	
6		8026265	VABM-B10-25S-G38-6	
7		8026266	VABM-B10-25S-G38-7	
8		8026267	VABM-B10-25S-G38-8	
9		8026268	VABM-B10-25S-G38-9	
10		8026269	VABM-B10-25S-G38-10	

Manifold block VABM

Ordering data – Manifold block, size 25

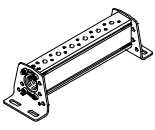
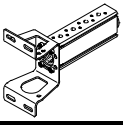

Ordering data			
Description	Valve positions	Part No.	Type
Supply manifold			
 <p>For mounting on both sides, incl. seals and screws for mounting valves</p>	2	8026219	VABM-B10-25-G12-2-P53
	3	8026220	VABM-B10-25-G12-3-P53
	4	8026221	VABM-B10-25-G12-4-P53
	5	8026222	VABM-B10-25-G12-5-P53
	6	8026223	VABM-B10-25-G12-6-P53
	7	8026224	VABM-B10-25-G12-7-P53
	8	8026225	VABM-B10-25-G12-8-P53
	9	8026226	VABM-B10-25-G12-9-P53
	10	8026227	VABM-B10-25-G12-10-P53
	 <p>For mounting on one side, incl. seals and screws for valve assembly</p>	2	8026237
3		8026238	VABM-B10-25-G12-3-P53-E
4		8026239	VABM-B10-25-G12-4-P53-E

-  - Note

Blanking plug for sealing the supply port (1) at one end included in the scope of delivery.

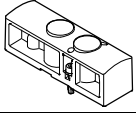

Manifold block VABM

Accessories – Manifold block, size 25

Ordering data			
Description	Weight [g]	Part No.	Type
Blanking plate			
 For valve position on manifold block for 5/2-, 5/3-way valves	117	8026209	VABB-B10-25-E
 For valve position on manifold block for 3/2-way valves	84	8026210	VABB-B10-25-E-P3
 For valve position on supply manifold	28	8026208	VABB-B10-25-A
Supply plate			
 For valve position on manifold block for 5/2-, 5/3-way valves	110	8026318	VABF-B10-25-P1A4-G14
 For valve position on manifold block for 3/2-way valves	80	8026319	VABF-B10-25-P1A4-G14-P3
 For valve position on supply manifold	26	8026317	VABF-B10-25-P1-G14

Manifold block VABM



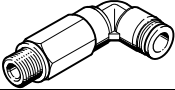

Accessories – Manifold block, size 25

Ordering data					
	Description		Part No.	Type	PJ ¹⁾
Push-in fitting with external hex					
	Connecting thread G3/8 for tubing O.D.	16 mm	186347	QS-G3/8-16	1
	Connecting thread G1/2 for tubing O.D.	16 mm	186105	QS-G1/2-16	1
			132047	QS-G1/2-16-20	20
Push-in fitting with internal hex					
	Connecting thread M5 for tubing O.D.	4 mm	153315	QSM-M5-4-I	10
	Connecting thread G1/8 for tubing O.D.	6 mm	186107	QS-G1/8-6-I	10
			133009	QS-G1/8-6-I-100	100
			186108	QS-G1/4-6-I	10
	Connecting thread G1/4 for tubing O.D.	6 mm	186110	QS-G1/4-8-I	10
		8 mm	186111	QS-G1/4-8-I	10
		10 mm	186112	QS-G1/4-10-I	10
	Connecting thread G3/8 for tubing O.D.	8 mm	186111	QS-G3/8-8-I	10
		10 mm	186113	QS-G3/8-10-I	10
		12 mm	186114	QS-G3/8-12-I	10
Connecting thread G1/2 for tubing O.D.	12 mm	186115	QS-G1/2-12-I	1	
Angled push-in fitting with external hex					
	Connecting thread G1/4 for tubing O.D.	6 mm	186118	QSL-G1/4-6	10
			132051	QSL-G1/4-6-100	100
		8 mm	186120	QSL-G1/4-8	10
			132052	QSL-G1/4-8-50	50
		10 mm	186122	QSL-G1/4-10	10
			132053	QSL-G1/4-10-50	50
	Connecting thread G3/8 for tubing O.D.	8 mm	186121	QSL-G3/8-8	10
			132055	QSL-G3/8-8-50	50
		10 mm	186123	QSL-G3/8-10	10
			132056	QSL-G3/8-10-20	20
		12 mm	186124	QSL-G3/8-12	10
			132057	QSL-G3/8-12-20	20
	Connecting thread G1/2 for tubing O.D.	12 mm	186125	QSL-G1/2-12	1
			132058	QSL-G1/2-12-20	20
		16 mm	186126	QSL-G1/2-16	1
132059	QSL-G1/2-16-20	20			
Angled push-in fitting, long, with external hex					
	Connecting thread G1/4 for tubing O.D.	6 mm	186129	QSL-G1/4-6	10
		8 mm	186131	QSL-G1/4-8	10
		10 mm	186133	QSL-G1/4-10	10

1) Packaging unit

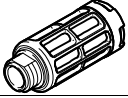
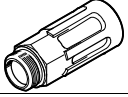
Manifold block VABM

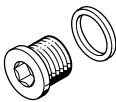
Accessories – Manifold block, size 25

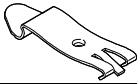
Ordering data					
	Description	Part No.	Type	PU ¹⁾	
Silencer					
	With connecting thread G, polymer design	G1/4	2316	U-1/4	1
			534223	U-1/4-20	20
		G3/8	534224	U-3/8-20	20
	With connecting thread G, metal design	G1/4	6842	U-1/4-B	1
			6843	U-3/8-B	1
		G1/2	6844	U-1/2-B	1
	With connecting thread G, sintered design, long	G3/8	1205862	AMTE-M-LH-G38	10
			G1/2	1205863	AMTE-M-LH-G12
Blanking plug					
	With connecting thread G	G1/8	3568	B-1/8	10
			534213	B-1/8-100	100
		G3/8	3570	B-3/8	10
			534215	B-3/8-20	20
		G1/2	3571	B-1/2	10
		534216	B-1/2-20	20	
Separator					
	For creating pressure zones	G1/8	569995	VABD-8-B	1
			574483	VABD-14-B	1
		G1/2	8022483	VABD-17.5-B	1
H-rail mounting					
	For size 25, for mounting on standard H-rails TH 35-7.5 or TH 35-15 to EN 60715	2636436	VAME-T-M5	2	

1) Packaging unit

Manifold block VABM

Technical data – Manifold block, size 30

-  Flow rate
Up to 2300 l/min

-  Valve width
31 mm



General technical data								
	Manifold block standard		Extension module for standard manifold block		Manifold block compact		Supply manifold	
							On both sides	On one side
For valves	3/2	5/2, 5/3	3/2	5/2, 5/3	3/2	5/2, 5/3	3/2, 5/2, 5/3	
Grid dimension [mm]	32							
Type of mounting	With through-hole						With mounting bracket	
Maximum number of valve positions	10	10	2	2	10	10	10	4
Port 1	G3/4	G3/4	G3/4	G3/4	G1/2	G1/2	G3/4	G3/4
Port 3	G3/4	G3/4	G3/4	G3/4	G1/2	G1/2	-	-
Port 5	-	G3/4	-	G3/4	-	G1/2	-	-
Port 12	G1/8	G1/8	G1/8	G1/8	-	-	-	-
Port 14	-	G1/8	-	G1/8	-	-	-	-
CRC ¹⁾	2 ¹⁾							

1) Corrosion resistance class CRC 2 to Festo standard FN 940070
Moderate corrosion stress. Indoor applications in which condensation may occur. External visible parts with primarily decorative requirements for the surface and which are in direct contact with the ambient atmosphere typical for industrial applications.

Weight [g]									
Valve positions	2	3	4	5	6	7	8	9	10
Manifold block for 3/2-way valves, standard									
VABM-B10-30E-G34-...-P3	1411	1828	2245	2662	3079	3496	3913	4330	4747
Manifold block, extension module for 3/2-way valves, standard									
VABM-B10-30EEE-G34-2-P3	1111	-	-	-	-	-	-	-	-
Manifold block for 5/2- and 5/3-way valves, standard									
VABM-B10-30E-G34-...	1722	2213	2703	3194	3684	4175	4665	5156	5646
Manifold block, extension module for 5/2- and 5/3-way valves, standard									
VABM-B10-30EEE-G34-2	1318	-	-	-	-	-	-	-	-
Manifold block for 3/2-way valves, compact									
VABM-B10-30S-G12-...-P3	652	872	1093	1313	1533	1753	1973	2193	2413
Manifold block for 5/2- and 5/3-way valves, compact									
VABM-B10-30S-G12-...	759	1013	1267	1522	1776	2030	2285	2539	2793
Supply manifold for mounting on both sides									
VABM-B10-30-G34-...-P53	818	977	1135	1293	1452	1610	1768	1927	2085
Supply manifold for mounting on one side									
VABM-B10-30-G34-...-P53-E	852	1011	1169	-	-	-	-	-	-

Information on materials	
Materials	Wrought aluminium alloy
Note on materials	RoHS compliant

Manifold block VABM

Technical data – Manifold block, size 30

Dimensions

Manifold block for 3/2-way valves, standard

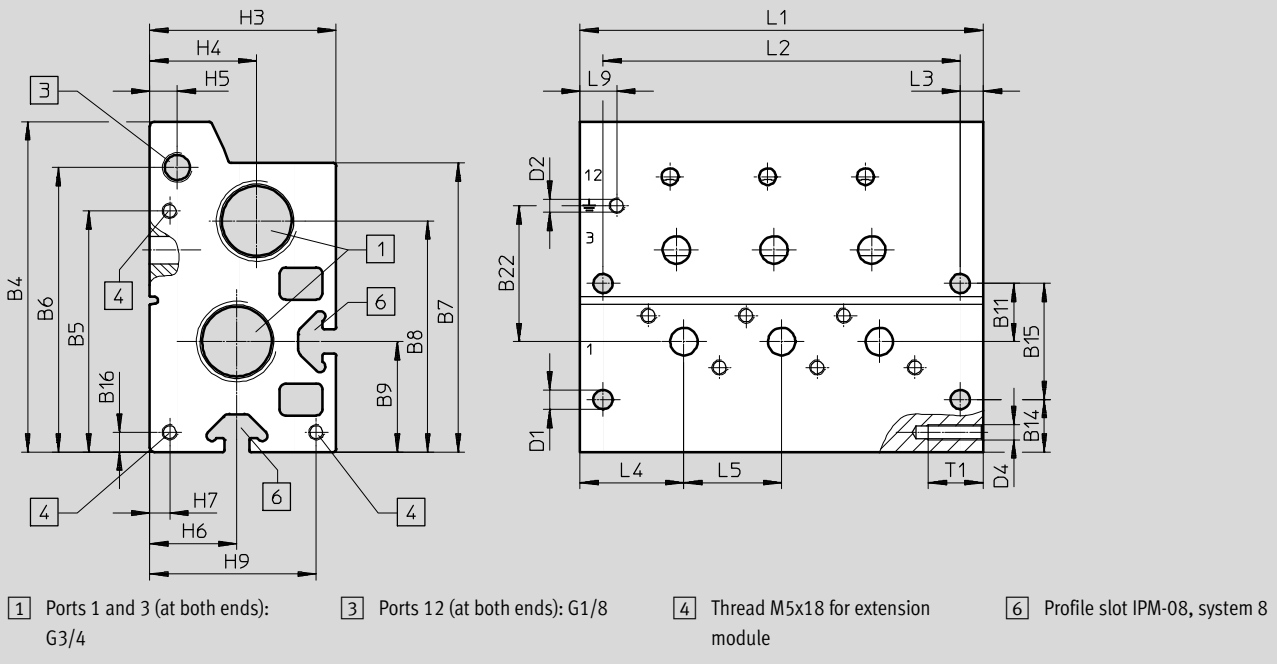

Type	B4	B5	B6	B7	B8	B9	B11	B14	B15	B16	B22
VABM-B10-30-E-G34-...-P3	108.2	79	93.2	94.7	75.7	36.2	19	17.2	38	6.5	44.5

Type	D1 Ø	D2	D4	H3	H4	H5	H6	H7	H9	L3	L4	L5	L9	T1
VABM-B10-30-E-G34-...-P3	6.3	M5x11	M5	61	35	9	28.5	6.5	54.5	7.5	34	32	12	18

Valve positions	2	3	4	5	6	7	8	9	10
L1 [mm]	100	132	164	196	228	260	292	324	356
L2 [mm]	85	117	149	181	213	245	277	309	341

Manifold block VABM

Technical data – Manifold block, size 30

Dimensions

Manifold block, extension module for 3/2-way valves, standard

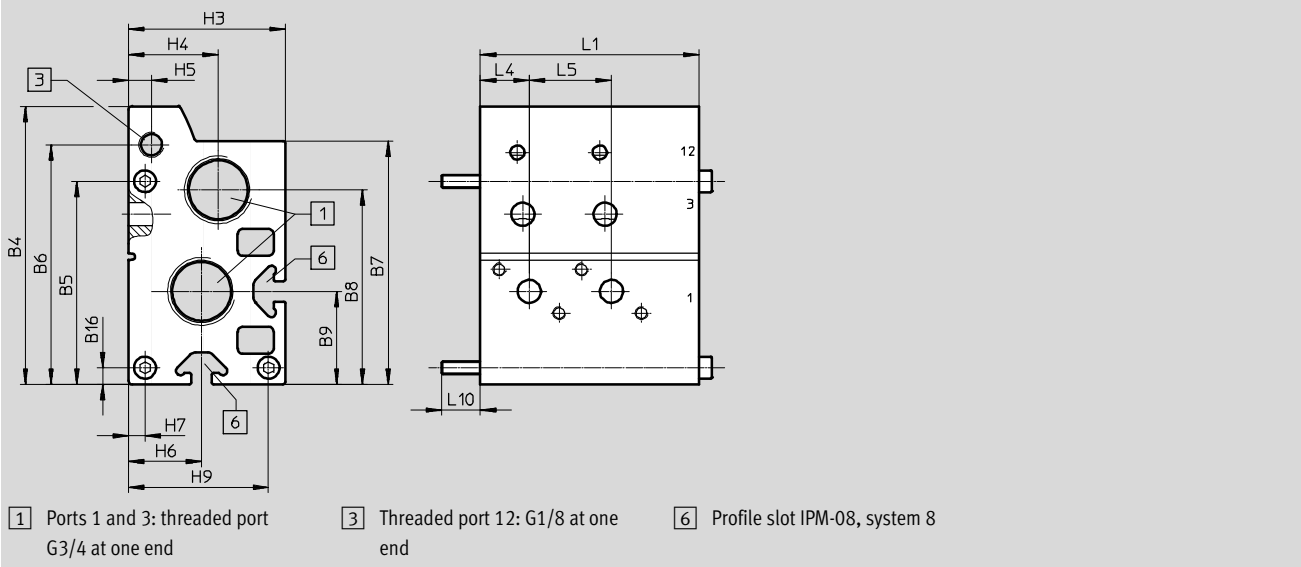

Type	B4	B5	B6	B7	B8	B9	B16	H3	H4	H5	H6	H7	H9	L4	L5	L10
VABM-B10-30EEE-G34-2-P3	108.2	79	93.2	94.7	75.7	36.2	6.5	61	35	9	28.5	6.5	54.5	19	32	15

Valve positions	2
L1 [mm]	85

Manifold block VABM

Technical data – Manifold block, size 30

Dimensions

Manifold block for 5/2- and 5/3-way valves, standard

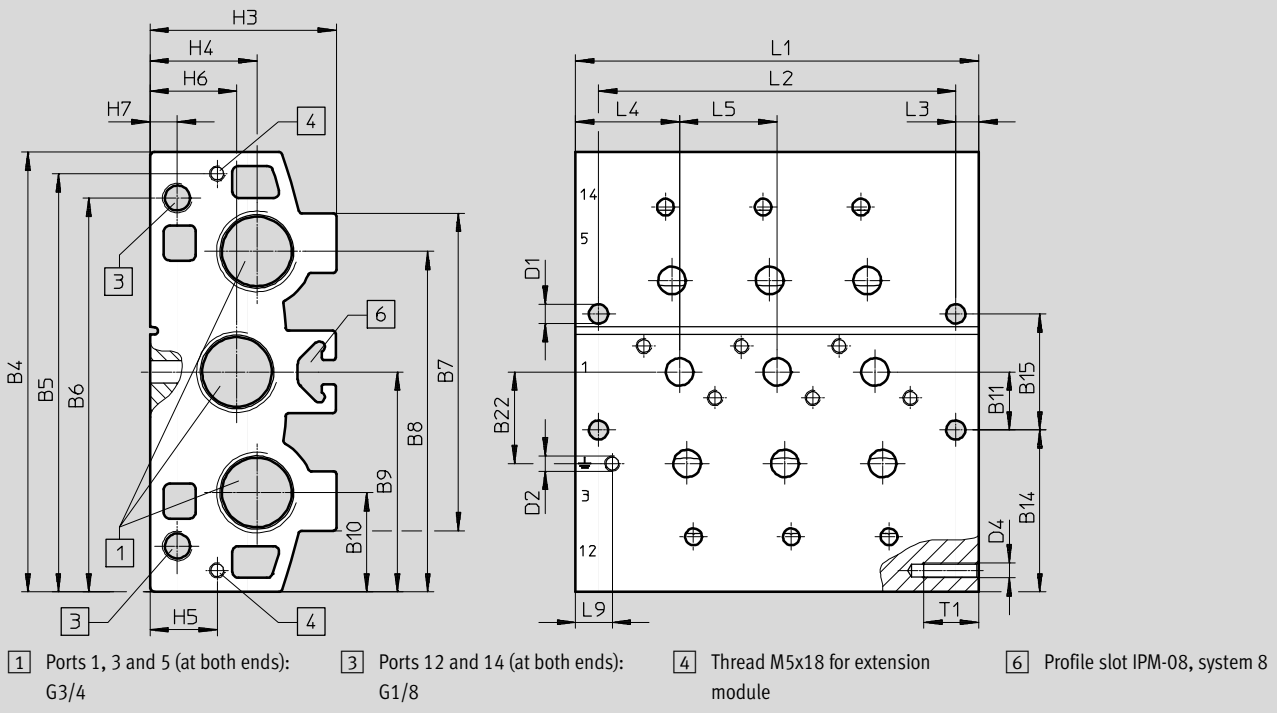

Type	B4	B5	B6	B7	B8	B9	B10	B11	B14	B15	B22
VABM-B10-30E-G34-...	144	137	129	104	111.5	72	32.5	19	53	38	30

Type	D1 Ø	D2	D4	H3	H4	H5	H6	H7	L3	L4	L5	L9	T1
VABM-B10-30E-G34-...	6.3	M5*11	M5	61	35	22	28.5	9	7.5	34	32	12	18

Valve positions	2	3	4	5	6	7	8	9	10
L1 [mm]	100	132	164	196	228	260	292	324	356
L2 [mm]	85	117	149	181	213	245	277	309	341

Manifold block VABM

Technical data – Manifold block, size 30

Dimensions

Manifold block, extension module for 5/2- and 5/3-way valves, standard

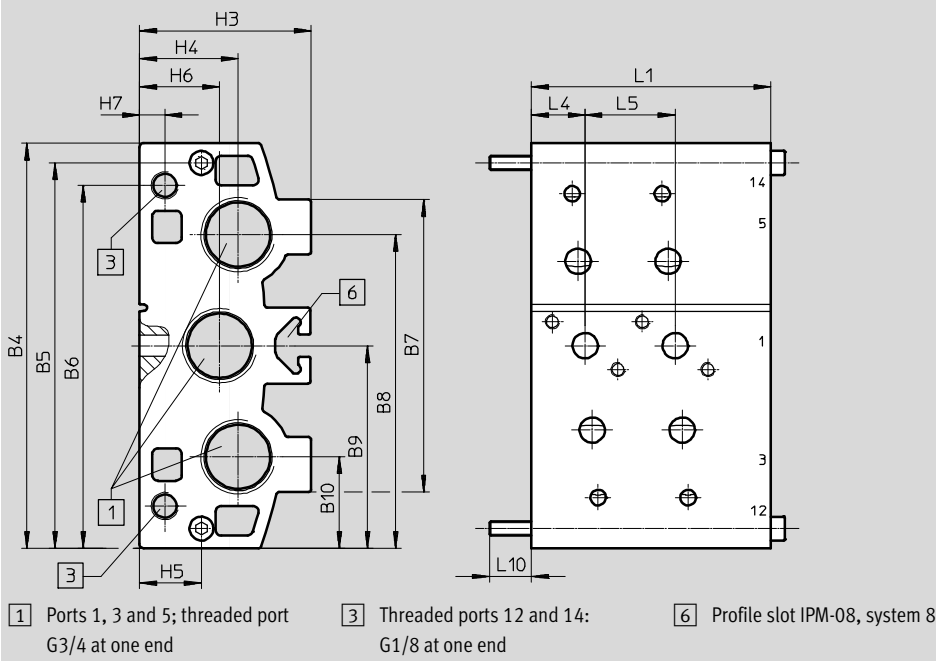

Type	B4	B5	B6	B7	B8	B9	B10	H3	H4	H5	H6	H7	L4	L5	L10
VABM-B10-30EEE-G34-2	144	137	129	104	111.5	72	32.5	61	35	22	28.5	9	19	32	15

Valve positions	2
L1 [mm]	85

Manifold block VABM

Technical data – Manifold block, size 30

Dimensions

Manifold block for 3/2-way valves, compact

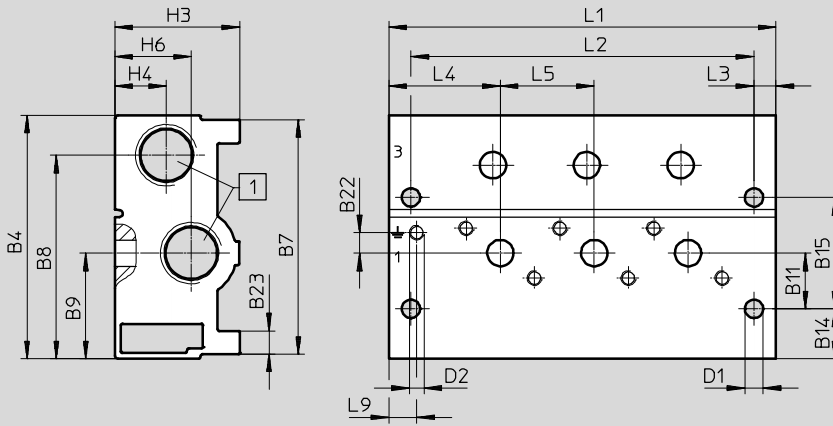

1 Ports 1 and 3 (at both ends):
G1/2

Type	B4	B7	B8	B9	B11	B14	B15	B22	B23
VABM-B10-30S-G12-...-P3	83	80	69.4	36	19	17	38	7	8

Type	D1 Ø	D2	H3	H4	H6	L3	L4	L5	L9
VABM-B10-30S-G12-...-P3	6.3	M5x11	42.5	17.5	26	7.5	38	32	12

Valve positions	2	3	4	5	6	7	8	9	10
L1 [mm]	100	132	164	196	228	260	292	324	356
L2 [mm]	85	117	149	181	213	245	277	309	341

Manifold block VABM

Technical data – Manifold block, size 30

Dimensions

Manifold block for 5/2- and 5/3-way valves, compact

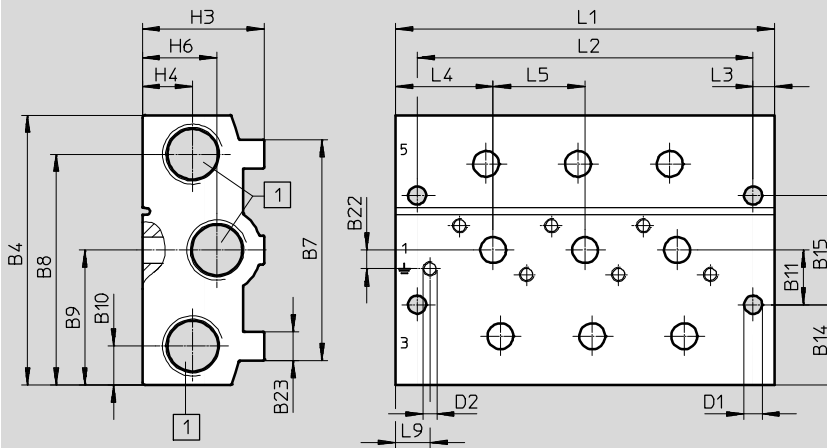

1 Ports 1, 3 and 5 (at both ends):
G1/2

Type	B4	B7	B8	B9	B10	B11	B14	B15	B22	B23
VABM-B10-30S-G12-...	94	77	80.4	47	13.6	19	28	38	6.5	10

Type	D1 Ø	D2	H3	H4	H6	L3	L4	L5	L9
VABM-B10-30S-G12-...	6.3	M5x11	42.5	17.5	26	7.5	34	32	12

Valve positions	2	3	4	5	6	7	8	9	10
L1 [mm]	100	132	164	196	228	260	292	324	356
L2 [mm]	85	117	149	181	213	245	277	309	341

Manifold block VABM

Technical data – Manifold block, size 30

Dimensions

Supply manifold, mounting on both sides

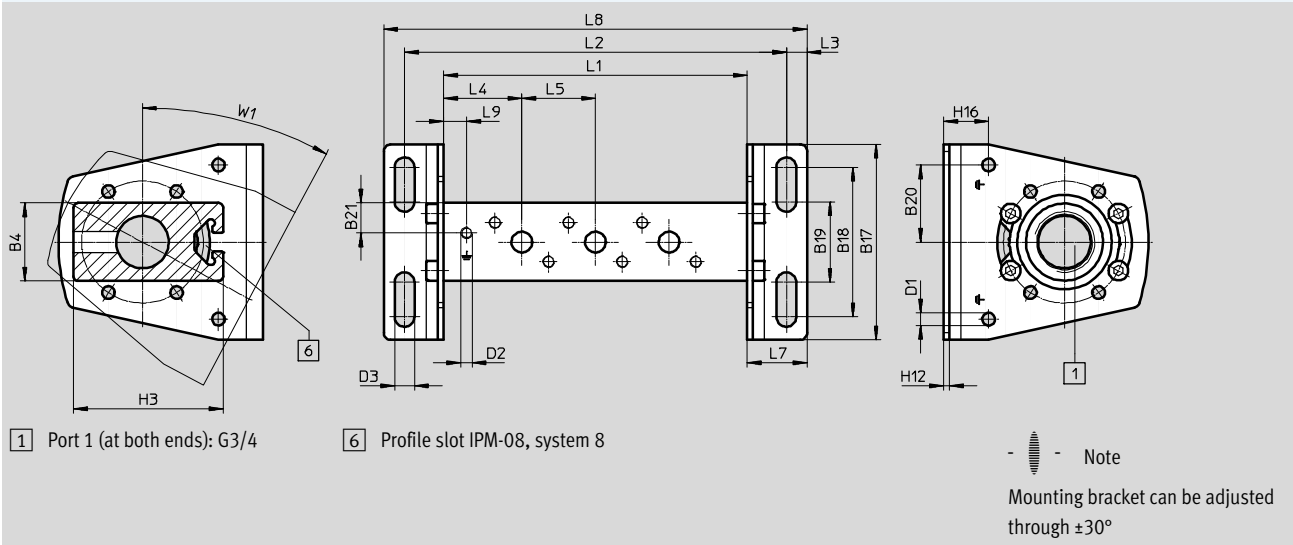

Type	B4	B17	B18	B19	B20	B21	D1 Ø	D2	D3 Ø	H3	H12	H16	L3	L4	L5	L7	L9	W1
VABM-B10-30-G34-...-P53	34	85	65	35	33.5	13	5.5	M5x11	8.6	65	2.5	19.5	9	34	32	26	10	28°

Valve positions	2	3	4	5	6	7	8	9	10
L1 [mm]	100	132	164	196	228	260	292	324	356
L2 [mm]	134	166	198	230	262	294	326	358	390
L8 [mm]	152	184	216	248	280	312	344	376	408

Dimensions

Supply manifold, mounting on one side

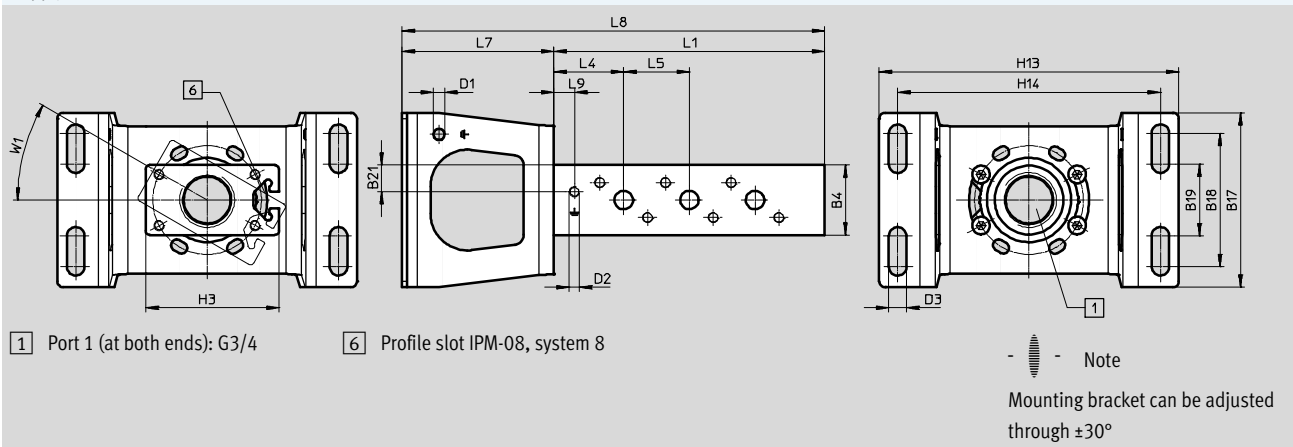







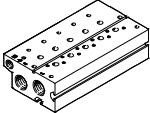

Type	B4	B17	B18	B19	B21	D1 Ø	D2	D3 Ø	H3	H13	H14	L4	L5	L7	L9	W1
VABM-B10-30-G34-...-P53-E	34	85	65	35	13	5.5	M5x11	8.6	65	146	128	34	32	74	10	30°

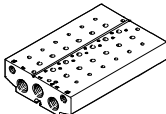
Valve positions	2	3	4
L1 [mm]	100	132	164
L8 [mm]	168	200	232

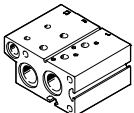
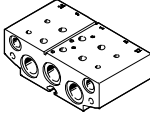
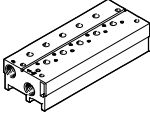
Manifold block VABM

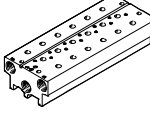
Ordering data – Manifold block, size 30

Ordering data				
Description	Valve positions	Part No.	Type	
Standard manifold block				
 <p>For 3/2-way valves, incl. seals and screws for mounting valves</p> <p>-  - Note Blanking plugs for sealing the supply ports (1, 3 and 14) at one end are included in the scope of delivery.</p>	2	8026395	VABM-B10-30E-G34-2-P3	
	3	8026396	VABM-B10-30E-G34-3-P3	
	4	8026397	VABM-B10-30E-G34-4-P3	
	5	8026398	VABM-B10-30E-G34-5-P3	
	6	8026399	VABM-B10-30E-G34-6-P3	
	7	8026400	VABM-B10-30E-G34-7-P3	
	8	8026401	VABM-B10-30E-G34-8-P3	
	9	8026402	VABM-B10-30E-G34-9-P3	
	10	8026403	VABM-B10-30E-G34-10-P3	
	 <p>For 5/2 and 5/3-way valves, incl. seals and screws for valve assembly</p> <p>-  - Note Blanking plugs for sealing the supply ports (1, 3, 5, 12 and 14) at one end are included in the scope of delivery.</p>	2	8026359	VABM-B10-30E-G34-2
3		8026360	VABM-B10-30E-G34-3	
4		8026361	VABM-B10-30E-G34-4	
5		8026362	VABM-B10-30E-G34-5	
6		8026363	VABM-B10-30E-G34-6	
7		8026364	VABM-B10-30E-G34-7	
8		8026365	VABM-B10-30E-G34-8	
9		8026366	VABM-B10-30E-G34-9	
10		8026367	VABM-B10-30E-G34-10	
Manifold block, extension module for standard manifold block				
 <p>For 3/2-way valves, incl. seals and screws for valve assembly</p>	2	8026432	VABM-B10-30EEE-G34-2-P3	
 <p>For 5/2 and 5/3-way valves, incl. seals and screws for valve assembly</p>	2	8026431	VABM-B10-30EEE-G34-2	
Compact manifold block				
 <p>For 3/2-way valves, incl. seals and screws for mounting valves</p> <p>-  - Note Blanking plugs for sealing the supply ports (1 and 3) at one end are included in the scope of delivery.</p>	2	8026413	VABM-B10-30S-G12-2-P3	
	3	8026414	VABM-B10-30S-G12-3-P3	
	4	8026415	VABM-B10-30S-G12-4-P3	
	5	8026416	VABM-B10-30S-G12-5-P3	
	6	8026417	VABM-B10-30S-G12-6-P3	
	7	8026418	VABM-B10-30S-G12-7-P3	
	8	8026419	VABM-B10-30S-G12-8-P3	
	9	8026420	VABM-B10-30S-G12-9-P3	
	10	8026421	VABM-B10-30S-G12-10-P3	
	 <p>For 5/2 and 5/3-way valves, incl. seals and screws for valve assembly</p> <p>-  - Note Blanking plugs for sealing the supply ports (1, 3 and 5) at one end are included in the scope of delivery.</p>	2	8026377	VABM-B10-30S-G12-2
3		8026378	VABM-B10-30S-G12-3	
4		8026379	VABM-B10-30S-G12-4	
5		8026380	VABM-B10-30S-G12-5	
6		8026381	VABM-B10-30S-G12-6	
7		8026382	VABM-B10-30S-G12-7	
8		8026383	VABM-B10-30S-G12-8	
9		8026384	VABM-B10-30S-G12-9	
10		8026385	VABM-B10-30S-G12-10	

Manifold block VABM

Ordering data – Manifold block, size 30

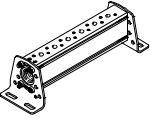
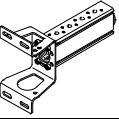



Ordering data			
Description	Valve positions	Part No.	Type
Supply manifold			
 <p>For mounting on both sides, incl. seals and screws for mounting valves</p>	2	8026338	VABM-B10-30-G34-2-P53
	3	8026339	VABM-B10-30-G34-3-P53
	4	8026340	VABM-B10-30-G34-4-P53
	5	8026341	VABM-B10-30-G34-5-P53
	6	8026342	VABM-B10-30-G34-6-P53
	7	8026343	VABM-B10-30-G34-7-P53
	8	8026344	VABM-B10-30-G34-8-P53
	9	8026345	VABM-B10-30-G34-9-P53
	10	8026346	VABM-B10-30-G34-10-P53
	 <p>For mounting on one side, incl. seals and screws for valve assembly</p>	2	8026356
3		8026357	VABM-B10-30-G34-3-P53-E
4		8026358	VABM-B10-30-G34-4-P53-E

-  - Note

Blanking plug for sealing the supply port (1) at one end included in the scope of delivery.

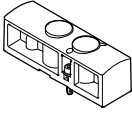
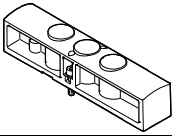

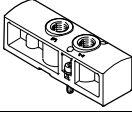
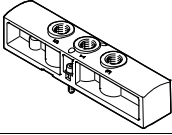

Manifold block VABM

Accessories – Manifold block, size 30

Ordering data				
Description		Weight [g]	Part No.	Type
Blanking plate				
	For valve position on manifold block for 3/2-way valves	128	8026336	VABB-B10-30-E-P3
	For valve position on manifold block for 5/2-, 5/3-way valves	179	8026335	VABB-B10-30-E
	For valve position on supply manifold	43	8026334	VABB-B10-30-A
Supply plate				
	For valve position on manifold block for 3/2-way valves	121	8026435	VABF-B10-30-P1A4-G38-P3
	For valve position on manifold block for 5/2-, 5/3-way valves	167	8026434	VABF-B10-30-P1A4-G38
	For valve position on supply manifold	40	8026433	VABF-B10-30-P1-G38

Manifold block VABM

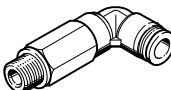



Accessories – Manifold block, size 30

Ordering data					
	Description		Part No.	Type	PU ¹⁾
Push-in fitting with internal hex					
	Connecting thread G1/8 for tubing O.D.	4 mm	186106	QS-G1/8-4-I	10
			133008	QS-G1/8-4-I-100	100
		6 mm	186107	QS-G1/8-6-I	10
			133009	QS-G1/8-6-I-100	100
	Connecting thread G3/8 for tubing O.D.	8 mm	186111	QS-G3/8-8-I	10
		10 mm	186113	QS-G3/8-10-I	10
		12 mm	186114	QS-G3/8-12-I	10
	Connecting thread G1/2 for tubing O.D.	12 mm	186115	QS-G1/2-12-I	1
Push-in fitting with external hex					
	Connecting thread G1/2 for tubing O.D.	16 mm	186105	QS-G1/2-16	1
			132047	QS-G1/2-16-20	20
Angled push-in fitting with external hex					
	Connecting thread G3/8 for tubing O.D.	8 mm	186121	QSL-G3/8-8	10
			132055	QSL-G3/8-8-50	50
		10 mm	186123	QSL-G3/8-10	10
			132056	QSL-G3/8-10-20	20
		12 mm	186124	QSL-G3/8-12	10
			132057	QSL-G3/8-12-20	20
	Connecting thread G1/2 for tubing O.D.	12 mm	186125	QSL-G1/2-12	1
			132058	QSL-G1/2-12-20	20
	16 mm	186126	QSL-G1/2-16	1	
		132059	QSL-G1/2-16-20	20	
Angled push-in fitting, long, with external hex					
	Connecting thread G1/2 for tubing O.D.	8 mm	186132	QSL-G3/8-8	10
		10 mm	186134	QSL-G3/8-10	10
		12 mm	186135	QSL-G3/8-12	10
Barbed fitting with external hex					
	Connecting thread G3/4 for tubing I.D. Aluminium design	13 mm	3612	N-3/4-P-13	1
		19 mm	3613	N-3/4-P-19	1
	Connecting thread G3/4 for tubing I.D. Brass design	13 mm	15637	N-3/4-P-13-MS	1
		19 mm	15638	N-3/4-P-19-MS	1

1) Packaging unit

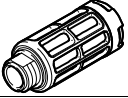
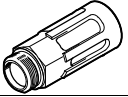
Manifold block VABM

Accessories – Manifold block, size 30

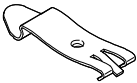
Ordering data					
	Description	Part No.	Type	PU ¹⁾	
Silencer					
	With connecting thread G, polymer design	G3/8	534224	U-3/8-B	20
	With connecting thread G, metal design	G3/8	6843	U-3/8-B	1
		G1/2	6844	U-1/2-B	1
		G3/4	6845	U-3/4-B	1
	With connecting thread G, sintered design, long	G1/2	1205863	AMTE-M-LH-G12	10
		G3/4	1205864	AMTE-M-LH-G34	10
Blanking plug					
	With connecting thread G	G1/8	3568	B-1/8	10
			534213	B-1/8-100	100
		G1/2	3571	B-1/2	10
			534216	B-1/2-20	20
		G3/4	3572	B-3/4	1
Separator					
	For creating pressure zones	G1/8	569995	VABD-8-B	1
		G1/2	8022483	VABD-17.5-B	1
		G3/4	8022484	VABD-22.7-B	1
H-rail mounting					
	For size 30, for mounting on standard H-rails TH 35-7.5 or TH 35-15 to EN 60715	3488412	VAME-T-M6	2	

1) Packaging unit