

## System extensions of the Multi-Fix series

Ball valve G3/8

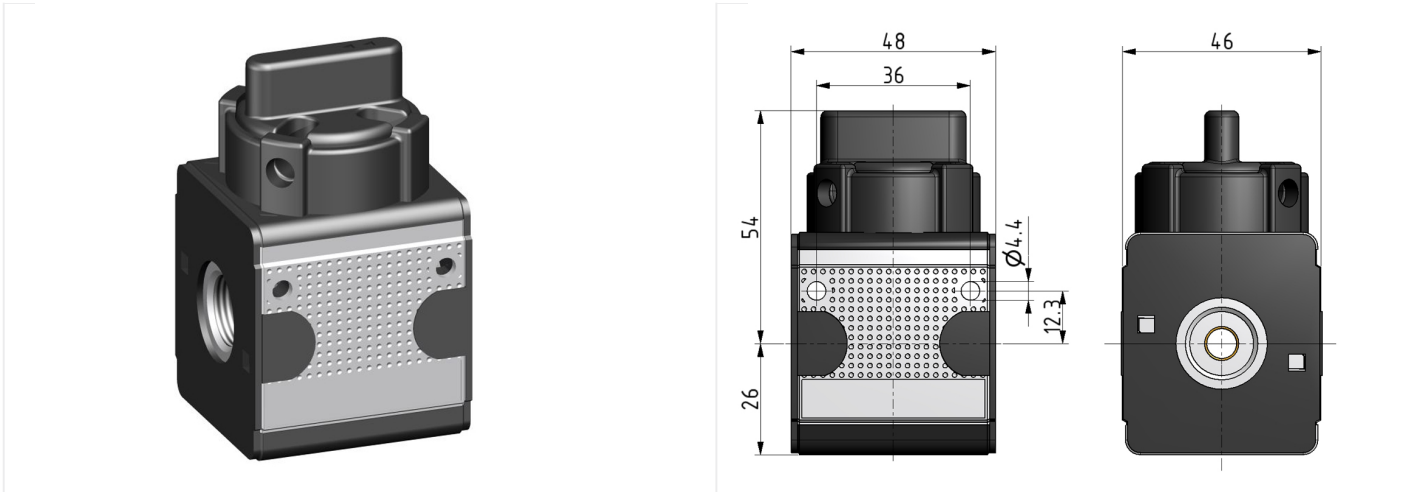

type	part-number	series	port size	flow rate	weight
K.12	025430	Multi-Fix	G 3/8	2800 l/min	0.346 kg

### flow characteristic

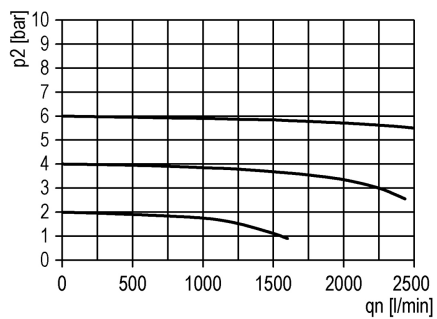

### symbol

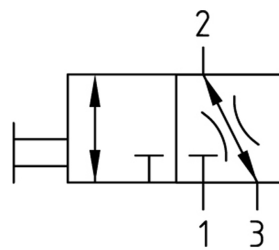

**technical data**

- **description:** 3/2 directional control valve, shut off for downstream air
- **medium:** compressed air, neutral gases
- **supply pressure P1 max.:** 16 bar
- **temperature range:** -10°C - +60°C
- **locking:** lockable with padlock
- **exhaust:** G 1/4
- **operating:** knob can be turned 90°

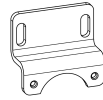
**accessories**

- mounting bracket: [ZW.11-1](#)